



HydroGeo

Ingegneria per l'Ambiente ed il Territorio

Studio Tecnico Associato Ingg. G. Gazzini, T. Staiano, A. Benvenuti



Via Cardinal Latino, 20

50126 Firenze

Tel 055 6587050 - Fax 055 0676043

e-mail info@studiohydrogeo.it

# STUDIO IDROLOGICO-IDRAULICO DI SUPPORTO AL PIANO OPERATIVO COMUNALE DI CARRARA E AGGIORNAMENTO AL PIANO DI GESTIONE RISCHIO ALLUVIONI

TAVOLA

# 4B

SCALA: varie

## MODELLO IDRAULICO MAESTRA E PARMIGNOLA

### LIBRETTO SEZIONI CON LIVELLI IDROMETRICI TR 30 - 200 - 500 ANNI

COMMITTENTE:



Comune di Carrara

Piazza 2 giugno, 1  
54033 Carrara

PROGETTISTI:

ING. ANDREA BENVENUTI

PROGETTO

L 5 2 2

LOTTO

0 1

FASE

S 0 3

DOC

D

ELABORATO

0 0 4 B

REV

A

REV.

DATA EMISSIONE

REDATTO

VERIFICATO

APPROVATO

A

Dicembre 2016

A.Benvenuti

A.Benvenuti

A.Benvenuti

Fosso Maestra

Fosso Maestra  
 SEZIONE N° 00271PC08

LEGENDA:

TR30 H =5.45 m. s.l.m. 

TR200 H =5.79 m. s.l.m. 

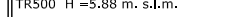
TR500 H =5.88 m. s.l.m. 

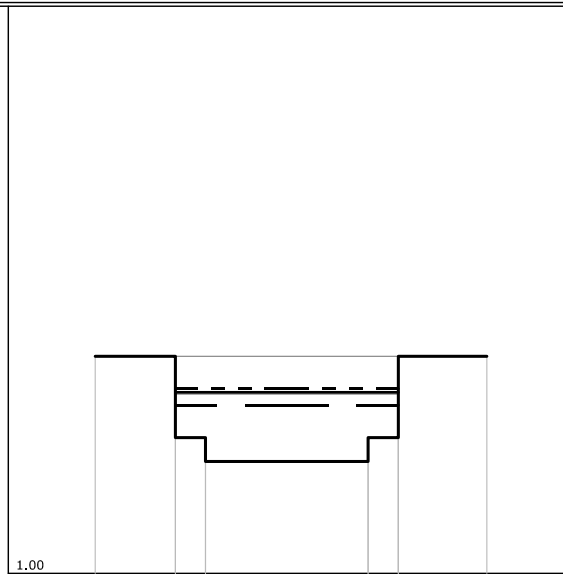

SCALA DISTANZE 1:200  
 SCALA QUOTE 1:200

PUNTI	1	2	4	6	8	11
QUOTE [m s.l.m.]	6.74	6.74	4.59	3.96	4.59	6.74
DISTANZE PROGRESSIVE [m]	0.00	2.12	2.92	7.22	8.02	10.36
DISTANZE PARZIALI [m]		2.12		4.30		2.34





Fosso Maestra  
 SEZIONE N° 00269PB06

LEGENDA:

TR30 H = 5.34 m. s.l.m. 

TR200 H = 5.61 m. s.l.m. 

TR500 H = 5.77 m. s.l.m. 

SCALA DISTANZE 1:200  
 SCALA QUOTE 1:200

1.00

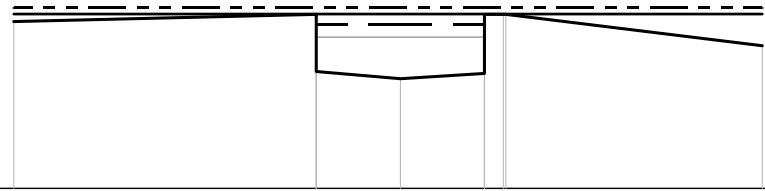



PUNTI	1	2	5	6	9	11
QUOTE [m s.l.m.]	5.41	5.60	3.90	4.04	5.60	4.77
DISTANZE PROGRESSIVE [m]	0.00	8.00	10.23	12.45	12.95	19.80
DISTANZE PARZIALI [m]		8.00	2.23	2.22		6.78

Fosso Maestra  
 SEZIONE N° 00269PC06

LEGENDA:

TR30 H = 5.26 m. s.l.m. 

TR200 H = 5.42 m. s.l.m. 

TR500 H = 5.51 m. s.l.m. 

SCALA DISTANZE 1:200  
 SCALA QUOTE 1:200

1.00

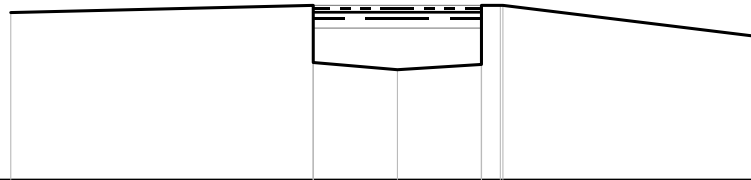



PUNTI	1	2	5	6	9	11
QUOTE [m s.l.m.]	5.41	5.60	3.90	4.04	5.60	4.77
DISTANZE PROGRESSIVE [m]	0.00	8.00	10.23	12.45	12.95	19.80
DISTANZE PARZIALI [m]		8.00	2.23	2.22		6.78

Fosso Maestra  
SEZIONE N° 00268\_\_06

LEGENDA:

TR30 H =5.26 m. s.l.m. 

TR200 H =5.42 m. s.l.m. 

TR500 H =5.51 m. s.l.m. 

SCALA DISTANZE 1:200  
SCALA QUOTE 1:200

1.00

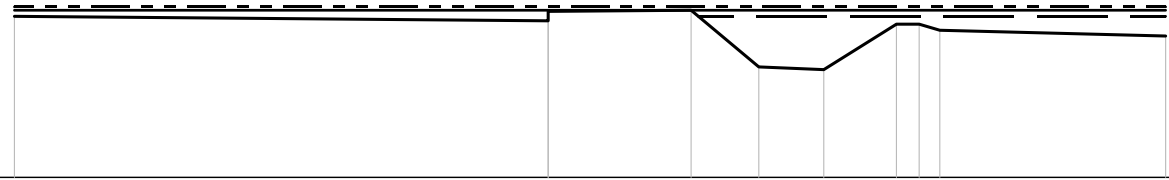

PUNTI	1	2	4	5	6	7	8	9	10
QUOTE [m s.l.m.]	5.26	5.14	5.42	3.92	3.85	5.05	5.05	4.89	4.74
DISTANZE PROGRESSIVE [m]	0.00	14.12	17.90	19.69	21.41	23.33	23.93	24.48	30.45
DISTANZE PARZIALI [m]		14.12	3.78	1.79	1.72	1.92			5.97



Fosso Maestra  
 SEZIONE N° 00265\_\_06

LEGENDA:

- TR30 H =5.12 m. s.l.m.
- TR200 H =5.14 m. s.l.m.
- TR500 H =5.19 m. s.l.m.

SCALA DISTANZE 1:200  
 SCALA QUOTE 1:200

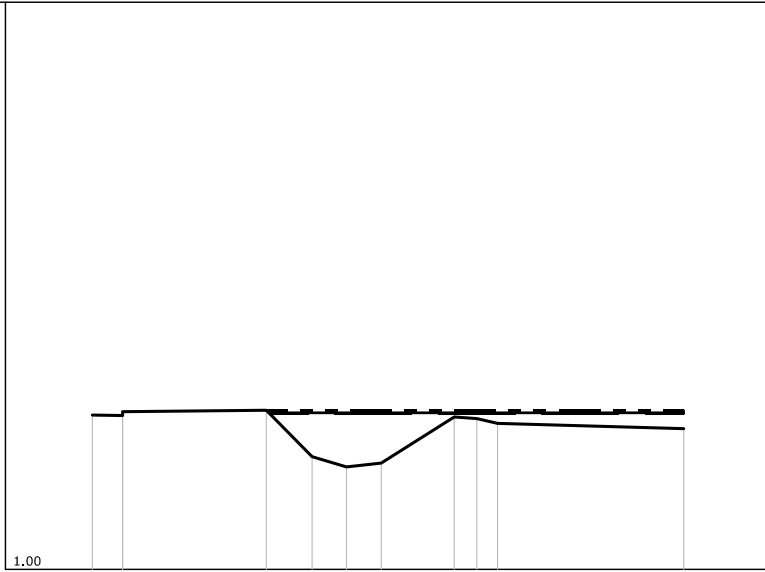

PUNTI	1	2	4	5	6	7	8	9	10	11
QUOTE [m s.l.m.]	5.08	5.07	5.21	3.98	3.71	3.81	5.03	4.99	4.86	4.72
DISTANZE PROGRESSIVE [m]	0.00	0.80	4.60	5.81	6.72	7.64	9.57	10.17	10.72	15.64
DISTANZE PARZIALI [m]			3.80	1.21			1.93			4.92

Fosso Maestra  
 SEZIONE N° 00263PA06

LEGENDA:

- TR30 H = 5.14 m. s.l.m.
- TR200 H = 5.17 m. s.l.m.
- TR500 H = 5.17 m. s.l.m.

SCALA DISTANZE 1:200  
 SCALA QUOTE 1:200

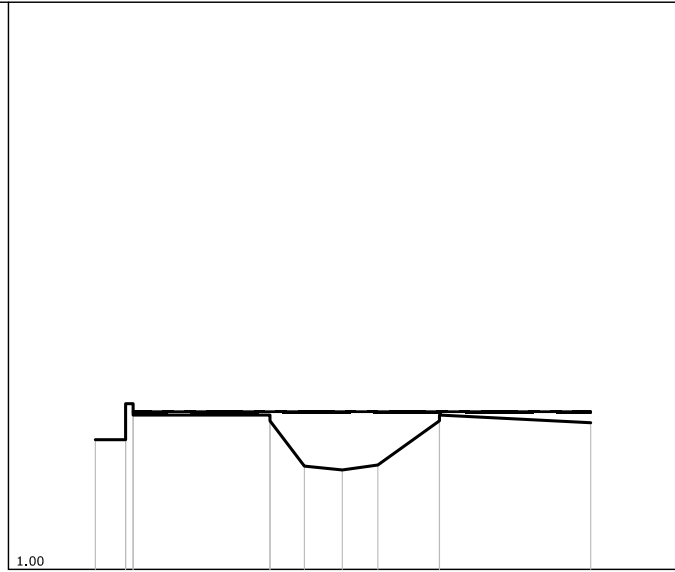

PUNTI	1	2	6	8	9	10	11	13
QUOTE [m s.l.m.]	4.43	4.43	5.08	3.73	3.63	3.76	4.93	4.88
DISTANZE PROGRESSIVE [m]	0.00	0.80	4.62	5.53	6.53	7.47	9.10	13.10
DISTANZE PARZIALI [m]			3.62	1.00	1.63	4.00		

Fosso Maestra  
SEZIONE N° 00263PB06

LEGENDA:

TR30 H = 5.14 m. s.l.m. \_\_\_\_\_

TR200 H = 5.17 m. s.l.m. \_\_\_\_\_

TR500 H = 5.17 m. s.l.m. - - - - -

SCALA DISTANZE 1:200  
SCALA QUOTE 1:200

1.00

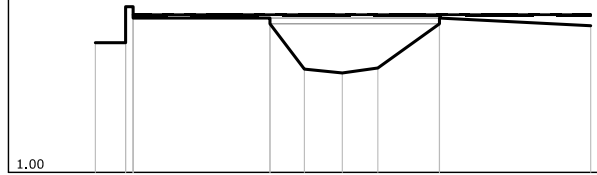

PUNTI	1	2	7	9	10	11	12	14
QUOTE [m s.l.m.]	4.43	4.43	5.08	3.73	3.63	3.76	4.93	4.88
DISTANZE PROGRESSIVE [m]	0.00	0.80	4.62	5.53	6.53	7.47	9.10	13.10
DISTANZE PARZIALI [m]			3.62	1.00	1.63	4.00		

Fosso Maestra  
 SEZIONE N° 00263PC06

LEGENDA:

- TR30 H = 5.10 m. s.l.m.
- TR200 H = 5.12 m. s.l.m.
- TR500 H = 5.13 m. s.l.m.

SCALA DISTANZE 1:200  
 SCALA QUOTE 1:200

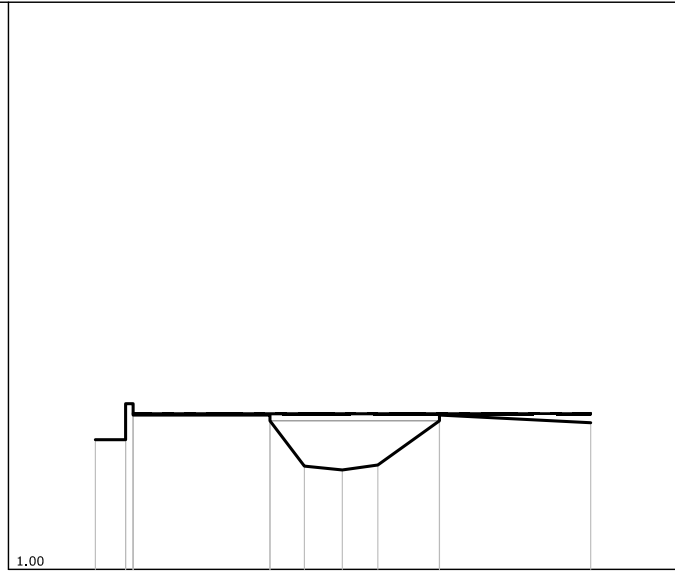

PUNTI	1	2		7	9	10	11	12		14
QUOTE [m s.l.m.]	4.43	4.43		5.08	3.73	3.63	3.76	4.93		4.88
DISTANZE PROGRESSIVE [m]	0.00	0.80		4.62	5.53	6.53	7.47	9.10		13.10
DISTANZE PARZIALI [m]			3.62		1.00		1.63	4.00		

Fosso Maestra  
 SEZIONE N° 00263PD06

LEGENDA:

- TR30 H = 5.10 m. s.l.m.
- TR200 H = 5.12 m. s.l.m.
- TR500 H = 5.13 m. s.l.m.

SCALA DISTANZE 1:200  
 SCALA QUOTE 1:200

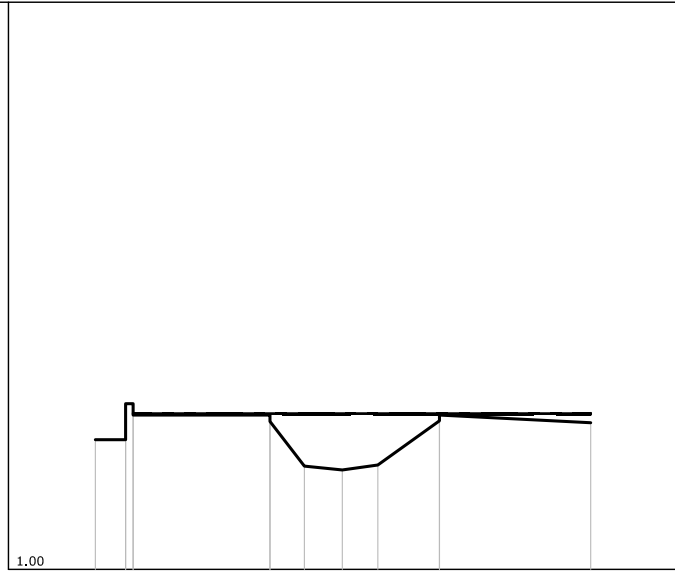



PUNTI	1	2	6	8	9	10	11	13
QUOTE [m s.l.m.]	4.43	4.43	5.08	3.73	3.63	3.76	4.93	4.88
DISTANZE PROGRESSIVE [m]	0.00	0.80	4.62	5.53	6.53	7.47	9.10	13.10
DISTANZE PARZIALI [m]			3.62	1.00	1.63	4.00		

Fosso Maestra  
 SEZIONE N° 00261\_\_06

LEGENDA:

TR30 H = 5,09 m. s.l.m. 

TR200 H = 5,11 m. s.l.m. 

TR500 H = 5,11 m. s.l.m. 

SCALA DISTANZE 1:200  
 SCALA QUOTE 1:200

1.00

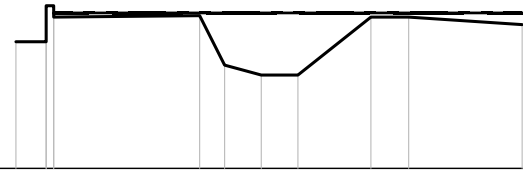



PUNTI	1	2	6	7	8	9	10	11	12
QUOTE [m s.l.m.]	4.35	4.35	5.04	3.73	3.47	3.47	5.00	5.00	4.80
DISTANZE PROGRESSIVE [m]	0.00	0.80	4.86	5.52	6.49	7.46	9.39	10.39	13.39
DISTANZE PARZIALI [m]			3.86	0.97	0.97	1.93	1.00	3.00	

Fosso Maestra  
 SEZIONE N° 00260PA06

LEGENDA:

TR30 H = 5.07 m. s.l.m. 

TR200 H = 5.10 m. s.l.m. 

TR500 H = 5.10 m. s.l.m. 

SCALA DISTANZE 1:200  
 SCALA QUOTE 1:200

1.00

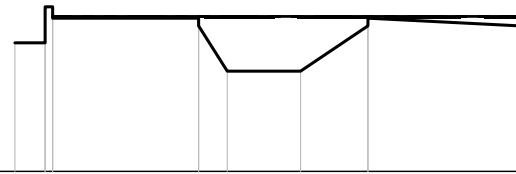



PUNTI	1	2	6	8	9	10	12
QUOTE [m s.l.m.]	4.40	4.40	5.05	3.65	3.65	4.85	4.85
DISTANZE PROGRESSIVE [m]	0.00	0.80	4.86	5.62	7.56	9.34	13.34
DISTANZE PARZIALI [m]			3.86	1.94	1.78	4.00	

Fosso Maestra  
 SEZIONE N° 00260PB06

LEGENDA:

TR30 H = 5.07 m. s.l.m. 

TR200 H = 5.09 m. s.l.m. 

TR500 H = 5.09 m. s.l.m. 

SCALA DISTANZE 1:200  
 SCALA QUOTE 1:200

1.00

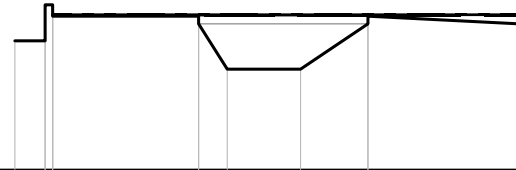



PUNTI	1	2	7	9	10	11	13
QUOTE [m s.l.m.]	4.40	4.40	5.05	3.65	3.65	4.85	4.85
DISTANZE PROGRESSIVE [m]	0.00	0.80	4.86	5.62	7.56	9.34	13.34
DISTANZE PARZIALI [m]			3.86	1.94	1.78	4.00	



Fosso Maestra  
 SEZIONE N° 00260PC06

LEGENDA:

TR30 H = 5.02 m. s.l.m. 

TR200 H = 5.05 m. s.l.m. 

TR500 H = 5.05 m. s.l.m. 

SCALA DISTANZE 1:200  
 SCALA QUOTE 1:200

1.00

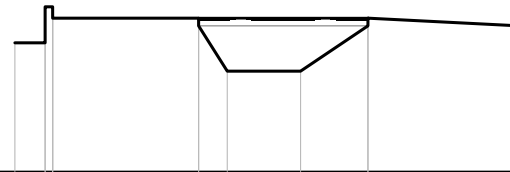



PUNTI	1	2	7	9	10	11	13
QUOTE [m s.l.m.]	4.40	4.40	5.05	3.65	3.65	4.85	4.85
DISTANZE PROGRESSIVE [m]	0.00	0.80	4.86	5.62	7.56	9.34	13.34
DISTANZE PARZIALI [m]			3.86	1.94	1.78	4.00	

Fosso Maestra  
 SEZIONE N° 00260PD06

LEGENDA:

TR30 H = 5.02 m. s.l.m. 

TR200 H = 5.05 m. s.l.m. 

TR500 H = 5.05 m. s.l.m. 

SCALA DISTANZE 1:200  
 SCALA QUOTE 1:200

1.00

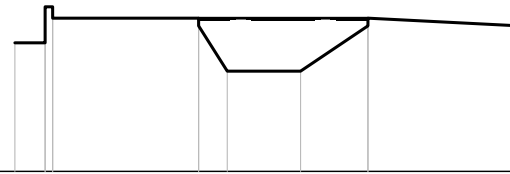

PUNTI	1	2	6	8	9	10	12
QUOTE [m s.l.m.]	4.40	4.40	5.05	3.65	3.65	4.85	4.85
DISTANZE PROGRESSIVE [m]	0.00	0.80	4.86	5.62	7.56	9.34	13.34
DISTANZE PARZIALI [m]			3.86	1.94	1.78	4.00	

Fosso Maestra  
 SEZIONE N° 00259\_\_06

LEGENDA:

- TR30 H =4.99 m. s.l.m.
- TR200 H =5.02 m. s.l.m.
- TR500 H =5.02 m. s.l.m.

SCALA DISTANZE 1:200  
 SCALA QUOTE 1:200

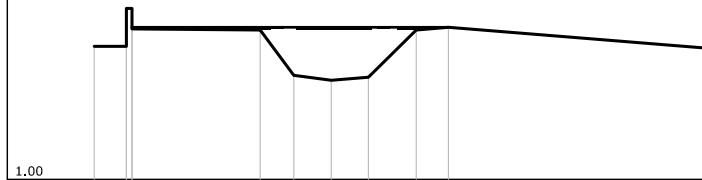



PUNTI	1	2	6	7	8	9	10	11	12
QUOTE [m s.l.m.]	4.52	4.52	4.95	3.75	3.62	3.70	4.95	5.02	4.46
DISTANZE PROGRESSIVE [m]	0.00	0.85	4.39	5.28	6.27	7.25	8.52	9.37	16.34
DISTANZE PARZIALI [m]			3.39	0.99	0.98	1.27			6.97

Fosso Maestra  
 SEZIONE N° 00258PA06

LEGENDA:

TR30 H =4.96 m. s.l.m. 

TR200 H =4.99 m. s.l.m. 

TR500 H =4.99 m. s.l.m. 

SCALA DISTANZE 1:200  
 SCALA QUOTE 1:200

1.00

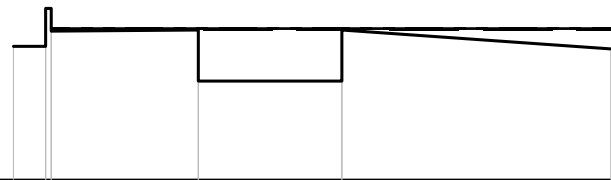

PUNTI	1	2	6	8	10
QUOTE [m s.l.m.]	4.52	4.52	4.95	3.60	4.45
DISTANZE PROGRESSIVE [m]	0.00	0.85	4.89	8.69	15.80
DISTANZE PARZIALI [m]			3.89	3.80	7.11

Fosso Maestra  
 SEZIONE N° 00258PB06

LEGENDA:

- TR30 H =4.96 m. s.l.m.
- TR200 H =4.99 m. s.l.m.
- TR500 H =4.99 m. s.l.m.

SCALA DISTANZE 1:200  
 SCALA QUOTE 1:200

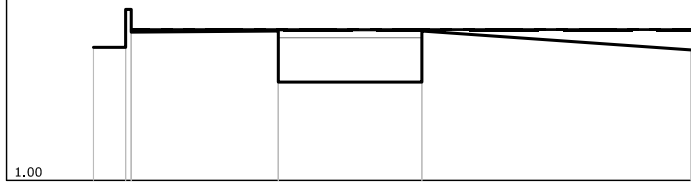

PUNTI	1	2	7	10	12
QUOTE [m s.l.m.]	4.52	4.52	4.95	3.60	4.45
DISTANZE PROGRESSIVE [m]	0.00	0.85	4.89	8.69	15.80
DISTANZE PARZIALI [m]			3.89	3.80	7.11

Fosso Maestra  
 SEZIONE N° 00258PC06

LEGENDA:

TR30 H =4.98 m. s.l.m. \_\_\_\_\_

TR200 H =4.98 m. s.l.m. \_\_\_\_\_

TR500 H =4.98 m. s.l.m. - - - - -

SCALA DISTANZE 1:200  
 SCALA QUOTE 1:200

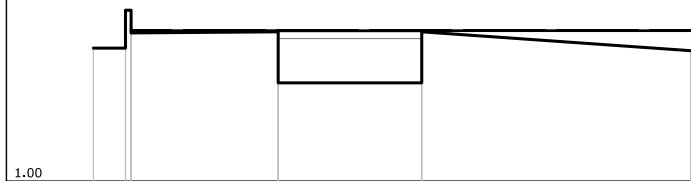

PUNTI	1	2	7	10	12
QUOTE [m s.l.m.]	4.52	4.52	4.95	3.60	4.45
DISTANZE PROGRESSIVE [m]	0.00	0.85	4.89	8.69	15.80
DISTANZE PARZIALI [m]			3.89	3.80	7.11

Fosso Maestra  
 SEZIONE N° 00258PD06

LEGENDA:

- TR30 H =4.95 m. s.l.m.
- TR200 H =4.95 m. s.l.m.
- TR500 H =4.95 m. s.l.m.

SCALA DISTANZE 1:200  
 SCALA QUOTE 1:200

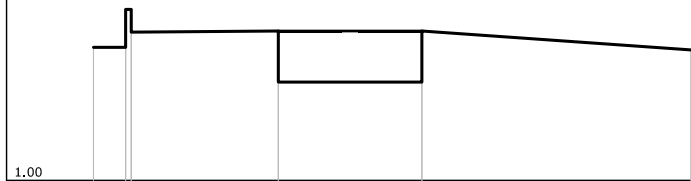

PUNTI	1	2	6	8	10
QUOTE [m s.l.m.]	4.52	4.52	4.95	3.60	4.45
DISTANZE PROGRESSIVE [m]	0.00	0.85	4.89	8.69	15.80
DISTANZE PARZIALI [m]			3.89	3.80	7.11

Fosso Maestra  
SEZIONE N° 00257PA06

LEGENDA:

TR30 H = 5.01 m. s.l.m. \_\_\_\_\_

TR200 H = 5.01 m. s.l.m. \_\_\_\_\_

TR500 H = 5.01 m. s.l.m. - - - - -

SCALA DISTANZE 1:200  
SCALA QUOTE 1:200

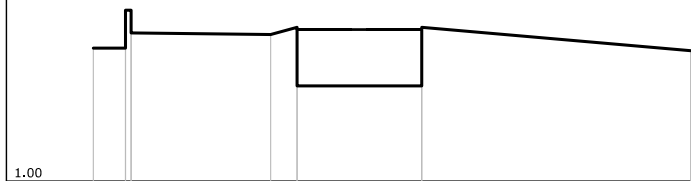

PUNTI	1	2	6	7	9	11
QUOTE [m s.l.m.]	4.52	4.52	4.88	5.07	3.52	4.45
DISTANZE PROGRESSIVE [m]	0.00	0.85	4.69	5.39	8.69	15.80
DISTANZE PARZIALI [m]			3.69		3.30	7.11



Fosso Maestra  
 SEZIONE N° 00257PB06

LEGENDA:

TR30 H = 5.01 m. s.l.m. \_\_\_\_\_

TR200 H = 5.01 m. s.l.m. \_\_\_\_\_

TR500 H = 5.01 m. s.l.m. - - - - -

SCALA DISTANZE 1:200  
 SCALA QUOTE 1:200

1.00

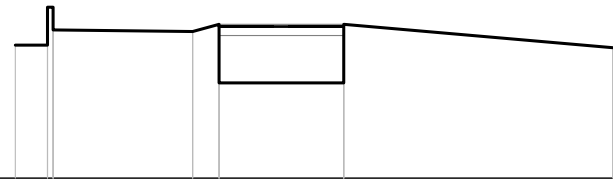

PUNTI	1	2	7	9	12	15
QUOTE [m s.l.m.]	4.52	4.52	4.88	5.07	3.52	4.45
DISTANZE PROGRESSIVE [m]	0.00	0.85	4.69	5.39	8.69	15.80
DISTANZE PARZIALI [m]			3.69		3.30	7.11

Fosso Maestra  
 SEZIONE N° 00257PC06

LEGENDA:

TR30 H =4.95 m. s.l.m. \_\_\_\_\_

TR200 H =4.95 m. s.l.m. \_\_\_\_\_

TR500 H =4.95 m. s.l.m. - - - - -

SCALA DISTANZE 1:200  
 SCALA QUOTE 1:200

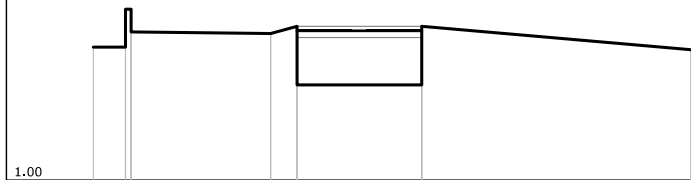

PUNTI	1	2	7	9	12	15
QUOTE [m s.l.m.]	4.52	4.52	4.88	5.07	3.52	4.45
DISTANZE PROGRESSIVE [m]	0.00	0.85	4.69	5.39	8.69	15.80
DISTANZE PARZIALI [m]			3.69		3.30	7.11

Fosso Maestra  
 SEZIONE N° 00257PD06

LEGENDA:

- TR30 H =4.92 m. s.l.m.
- TR200 H =4.92 m. s.l.m.
- TR500 H =4.92 m. s.l.m.

SCALA DISTANZE 1:200  
 SCALA QUOTE 1:200

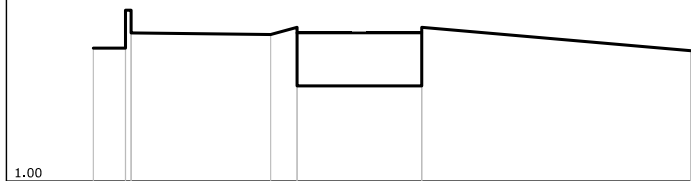

PUNTI	1	2	6	7	9	11
QUOTE [m s.l.m.]	4.52	4.52	4.88	5.07	3.52	4.45
DISTANZE PROGRESSIVE [m]	0.00	0.85	4.69	5.39	8.69	15.80
DISTANZE PARZIALI [m]			3.69		3.30	7.11

Fosso Maestra  
 SEZIONE N° 00256\_\_06

LEGENDA:

TR30 H =4.81 m. s.l.m. ———

TR200 H =4.86 m. s.l.m. ———

TR500 H =4.86 m. s.l.m. - - - - -

SCALA DISTANZE 1:200  
 SCALA QUOTE 1:200

1.00

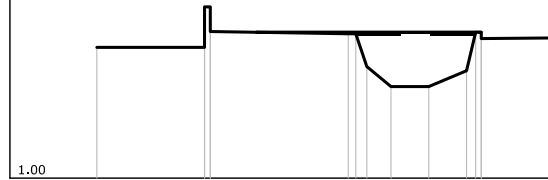

PUNTI	1	2	6	8	9	10	11	13	15
QUOTE [m s.l.m.]	4.46	4.46	4.82	3.95	3.42	3.42	3.84	4.86	4.71
DISTANZE PROGRESSIVE [m]	0.00	2.85	6.65	7.14	7.78	8.78	9.78	10.17	12.17
DISTANZE PARZIALI [m]		2.85	3.65	0.50	0.64	1.00	1.00	2.00	

Fosso Maestra  
 SEZIONE N° 00252\_\_06

LEGENDA:

TR30 H =4,68 m. s.l.m. ————

TR200 H =4,69 m. s.l.m. ————

TR500 H =4,69 m. s.l.m. - - - - -

SCALA DISTANZE 1:200  
 SCALA QUOTE 1:200

1.00

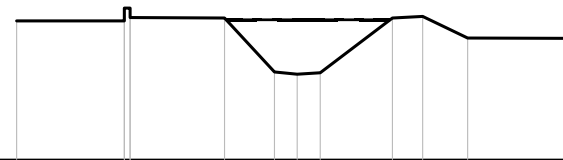

PUNTI	1	2	6	7	8	9	10	11	12	13
QUOTE [m s.l.m.]	4,66	4,66	4,74	3,31	3,25	3,29	4,74	4,78	4,21	4,20
DISTANZE PROGRESSIVE [m]	0,00	2,85	5,50	6,82	7,42	8,03	9,94	10,74	11,93	14,52
DISTANZE PARZIALI [m]		2,85	2,50	1,32		1,91		1,19	2,59	

Fosso Maestra  
 SEZIONE N° 00248\_\_06

LEGENDA:

TR30 H =4.58 m. s.l.m. \_\_\_\_\_

TR200 H =4.61 m. s.l.m. \_\_\_\_\_

TR500 H =4.63 m. s.l.m. - - - - -

SCALA DISTANZE 1:200  
 SCALA QUOTE 1:200

1.00

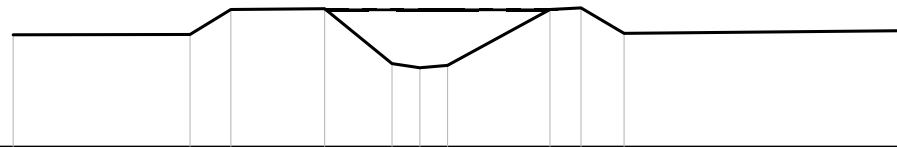

PUNTI	1	2	3	4	5	6	7	8	9	10	11
QUOTE [m s.l.m.]	3.95	3.96	4.62	4.64	3.19	3.08	3.14	4.62	4.66	3.99	4.06
DISTANZE PROGRESSIVE [m]	0.00	4.68	5.76	8.24	10.02	10.76	11.49	14.20	15.02	16.16	23.75
DISTANZE PARZIALI [m]		4.68	1.08	2.48	1.78			2.71	1.14		7.59

Fosso Maestra  
 SEZIONE N° 00246PA06

LEGENDA:

TR30 H =4.56 m. s.l.m. \_\_\_\_\_

TR200 H =4.75 m. s.l.m. \_\_\_\_\_

TR500 H =4.76 m. s.l.m. - - - - -

SCALA DISTANZE 1:200  
 SCALA QUOTE 1:200

1.00

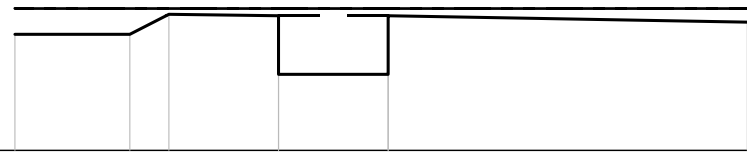



PUNTI	1	2	3	4	6	8
QUOTE [m s.l.m.]	4.07	4.07	4.60	4.56	3.01	4.39
DISTANZE PROGRESSIVE [m]	0.00	3.04	4.07	6.97	9.87	19.37
DISTANZE PARZIALI [m]		3.04	1.03	2.90	2.90	9.50

Fosso Maestra  
 SEZIONE N° 00246PB06

LEGENDA:

TR30 H =4.54 m. s.l.m. 

TR200 H =4.89 m. s.l.m. 

TR500 H =4.89 m. s.l.m. 

SCALA DISTANZE 1:200  
 SCALA QUOTE 1:200

1.00

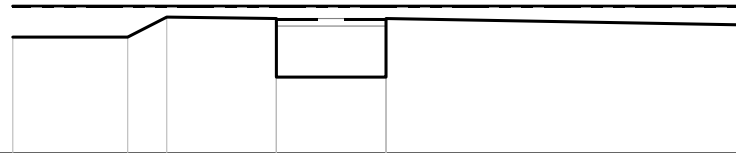



PUNTI	1	2	3	4	7	10
QUOTE [m s.l.m.]	4.07	4.07	4.60	4.56	3.01	4.39
DISTANZE PROGRESSIVE [m]	0.00	3.04	4.07	6.97	9.87	19.37
DISTANZE PARZIALI [m]		3.04	1.03	2.90	2.90	9.50



Fosso Maestra  
 SEZIONE N° 00246PC06

LEGENDA:

TR30 H =4.72 m. s.l.m. 

TR200 H =4.76 m. s.l.m. 

TR500 H =4.76 m. s.l.m. 

SCALA DISTANZE 1:200  
 SCALA QUOTE 1:200

1.00

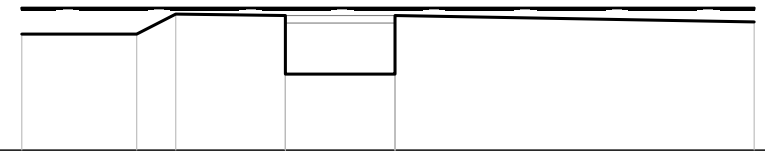

PUNTI	1	2	3	4	7	10
QUOTE [m s.l.m.]	4.07	4.07	4.60	4.56	3.01	4.39
DISTANZE PROGRESSIVE [m]	0.00	3.04	4.07	6.97	9.87	19.37
DISTANZE PARZIALI [m]		3.04	1.03	2.90	2.90	9.50

Fosso Maestra  
 SEZIONE N° 00246PD06

LEGENDA:

TR30 H =4.60 m. s.l.m. ———

TR200 H =4.69 m. s.l.m. ———

TR500 H =4.69 m. s.l.m. - - - - -

SCALA DISTANZE 1:200  
 SCALA QUOTE 1:200

1.00

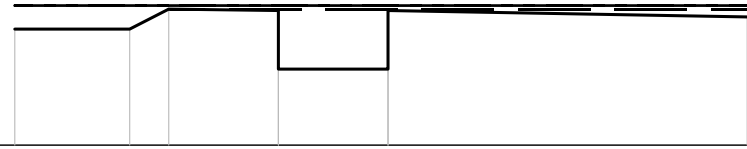

PUNTI	1	2	3	4	6	8
QUOTE [m s.l.m.]	4.07	4.07	4.60	4.56	3.01	4.39
DISTANZE PROGRESSIVE [m]	0.00	3.04	4.07	6.97	9.87	19.37
DISTANZE PARZIALI [m]		3.04	1.03	2.90	2.90	9.50

Fosso Maestra  
SEZIONE N° 00245\_\_06

LEGENDA:

TR30 H =4.56 m. s.l.m. 

TR200 H =4.67 m. s.l.m. 

TR500 H =4.67 m. s.l.m. 

SCALA DISTANZE 1:200  
SCALA QUOTE 1:200

0.00

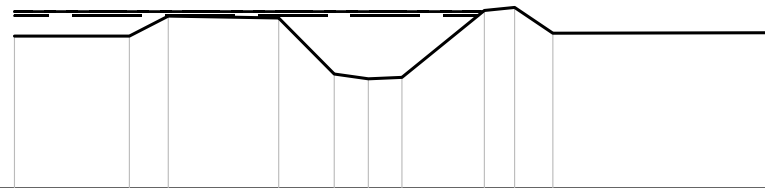

PUNTI	1	2	3	4	5	6	7	8	9	10	11
QUOTE [m s.l.m.]	4.02	4.02	4.55	4.50	3.02	2.89	2.93	4.70	4.78	4.10	4.11
DISTANZE PROGRESSIVE [m]	0.00	3.04	4.07	6.99	8.46	9.36	10.25	12.43	13.23	14.24	20.23
DISTANZE PARZIALI [m]		3.04	1.03	2.92	1.47		2.18		1.01	5.99	

Fosso Maestra  
 SEZIONE N° 00241\_\_06

LEGENDA:

TR30 H =4.41 m. s.l.m. 

TR200 H =4.45 m. s.l.m. 

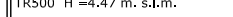
TR500 H =4.47 m. s.l.m. 

SCALA DISTANZE 1:200  
 SCALA QUOTE 1:200

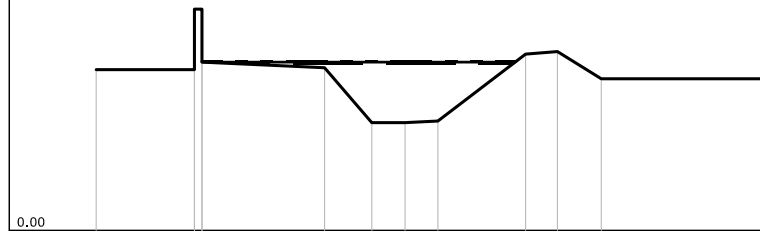

PUNTI	1	2	6	7	8	9	10	11	12	13
QUOTE [m s.l.m.]	4.25	4.25	4.30	2.85	2.85	2.89	4.66	4.73	4.01	4.01
DISTANZE PROGRESSIVE [m]	0.00	2.60	6.04	7.29	8.17	9.04	11.36	12.20	13.36	17.77
DISTANZE PARZIALI [m]		2.60	3.24	1.25			2.32	1.16	4.41	

Fosso Maestra  
 SEZIONE N° 00237\_\_06

LEGENDA:

TR30 H =4.30 m. s.l.m. \_\_\_\_\_

TR200 H =4.30 m. s.l.m. \_\_\_\_\_

TR500 H =4.34 m. s.l.m. - - - - -

SCALA DISTANZE 1:200  
 SCALA QUOTE 1:200

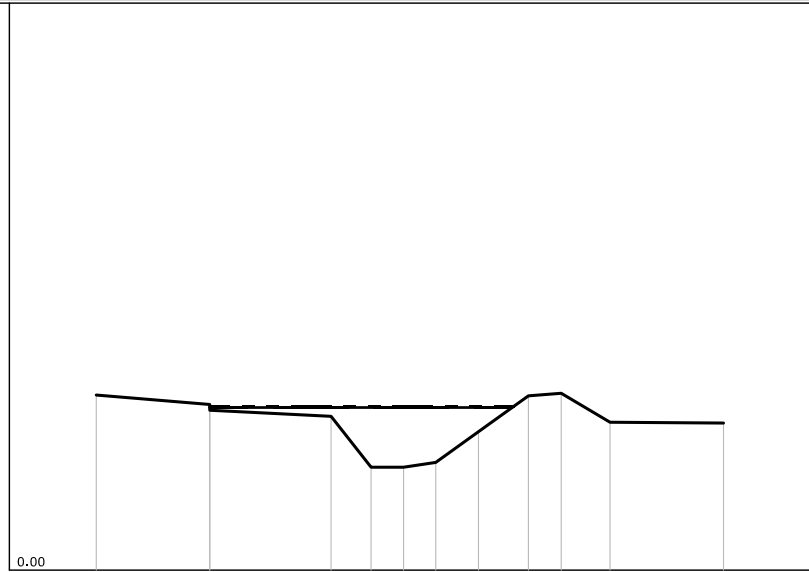



PUNTI	1	2	4	5	6	7	8	9	10	11	12
QUOTE [m s.l.m.]	4.63	4.38	4.07	2.72	2.72	2.85	3.66	4.61	4.68	3.91	3.89
DISTANZE PROGRESSIVE [m]	0.00	3.00	6.21	7.27	8.13	8.98	10.11	11.43	12.30	13.59	16.59
DISTANZE PARZIALI [m]		3.00	3.21	1.06			1.13	1.32		1.29	3.00

Fosso Maestra  
 SEZIONE N° 00236PA06

LEGENDA:

TR30 H =4.29 m. s.l.m. 

TR200 H =4.32 m. s.l.m. 

TR500 H =4.32 m. s.l.m. 

SCALA DISTANZE 1:200  
 SCALA QUOTE 1:200

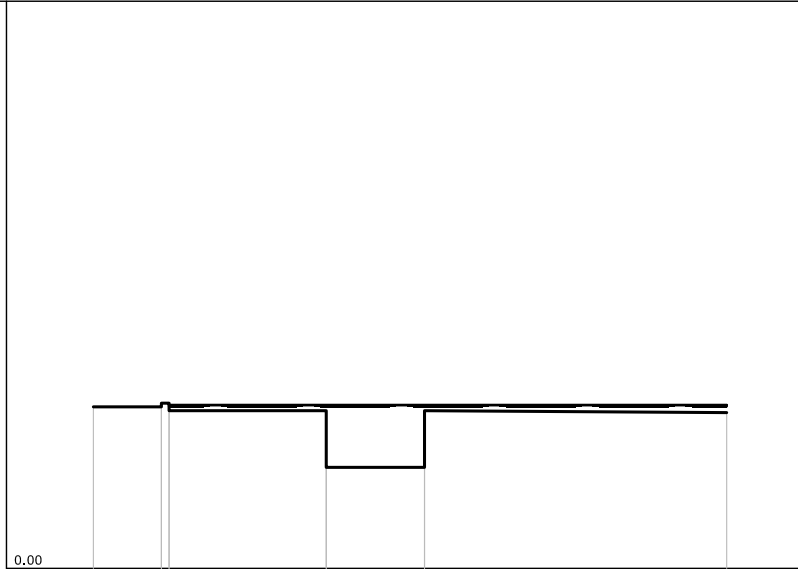

PUNTI	1	2	6	8	10
QUOTE [m s.l.m.]	4.27	4.27	4.17	2.67	4.12
DISTANZE PROGRESSIVE [m]	0.00	1.80	6.16	8.76	16.75
DISTANZE PARZIALI [m]	1.80	4.16	2.60	7.99	

Fosso Maestra  
 SEZIONE N° 00236PB06

LEGENDA:

- TR30 H =4.40 m. s.l.m.
- TR200 H =4.46 m. s.l.m.
- TR500 H =4.47 m. s.l.m.

SCALA DISTANZE 1:200  
 SCALA QUOTE 1:200

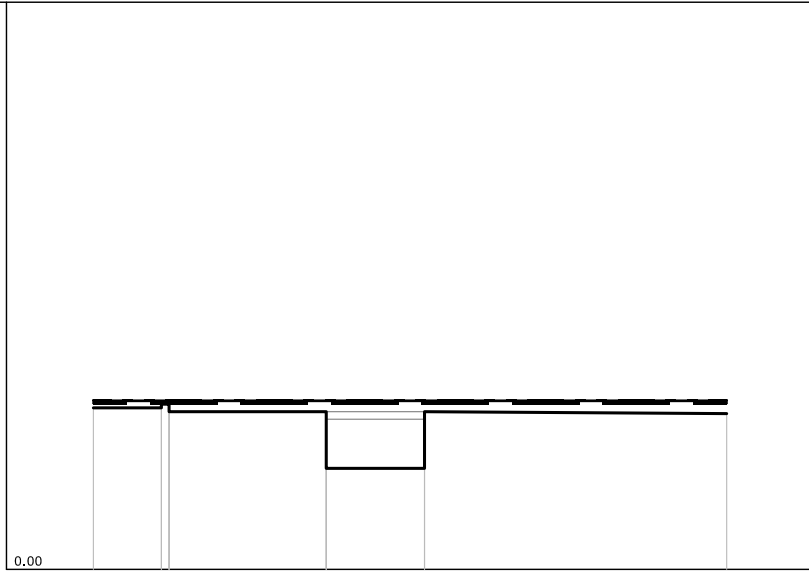



PUNTI	1	2	7	10	12
QUOTE [m s.l.m.]	4.27	4.27	4.17	2.67	4.12
DISTANZE PROGRESSIVE [m]	0.00	1.80	6.16	8.76	16.75
DISTANZE PARZIALI [m]		1.80	4.16	2.60	7.99

Fosso Maestra  
 SEZIONE N° 00236PC06

LEGENDA:

TR30 H =4.21 m. s.l.m. 

TR200 H =4.27 m. s.l.m. 

TR500 H =4.32 m. s.l.m. 

SCALA DISTANZE 1:200  
 SCALA QUOTE 1:200

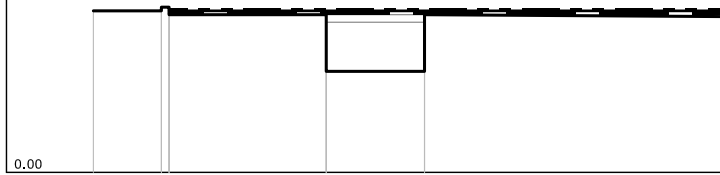

PUNTI	1	2	7	10	12
QUOTE [m s.l.m.]	4.27	4.27	4.17	2.67	4.12
DISTANZE PROGRESSIVE [m]	0.00	1.80	6.16	8.76	16.75
DISTANZE PARZIALI [m]	1.80	4.16	2.60	7.99	



Fosso Maestra  
 SEZIONE N° 00236PD06

LEGENDA:

- TR30 H =4.20 m. s.l.m.
- TR200 H =4.24 m. s.l.m.
- TR500 H =4.24 m. s.l.m.

SCALA DISTANZE 1:200  
 SCALA QUOTE 1:200

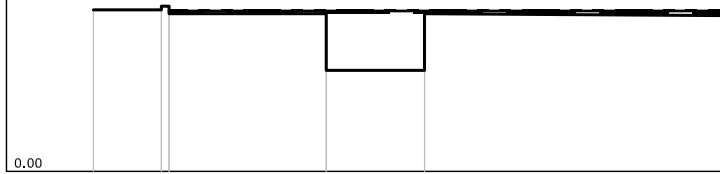

PUNTI	1	2	6	8	10
QUOTE [m s.l.m.]	4.27	4.27	4.17	2.67	4.12
DISTANZE PROGRESSIVE [m]	0.00	1.80	6.16	8.76	16.75
DISTANZE PARZIALI [m]		1.80	4.16	2.60	7.99

Fosso Maestra  
 SEZIONE N° 00235\_\_06

LEGENDA:

TR30 H =4.12 m. s.l.m. 

TR200 H =4.15 m. s.l.m. 

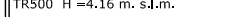
TR500 H =4.16 m. s.l.m. 

SCALA DISTANZE 1:200  
 SCALA QUOTE 1:200

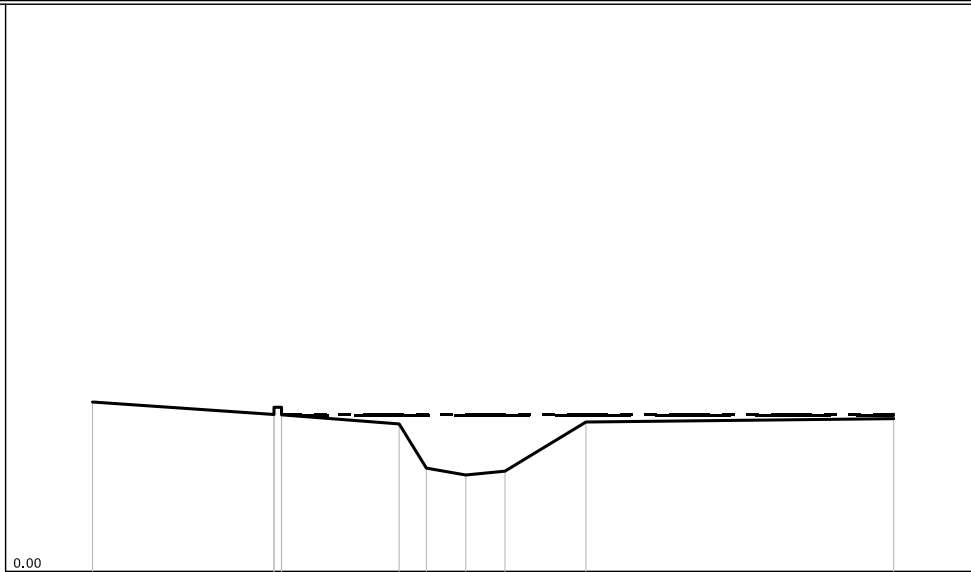



PUNTI	1	2	6	7	8	9	10	11
QUOTE [m s.l.m.]	4.48	4.15	3.90	2.73	2.55	2.65	3.95	4.04
DISTANZE PROGRESSIVE [m]	0.00	4.80	8.11	8.83	9.87	10.91	13.05	21.19
DISTANZE PARZIALI [m]		4.80	3.11	1.04	1.04	2.14	8.14	

Fosso Maestra  
 SEZIONE N° 00230\_\_06

LEGENDA:

TR30 H =3,96 m. s.l.m. 

TR200 H =3,98 m. s.l.m. 

TR500 H =4,01 m. s.l.m. 

SCALA DISTANZE 1:200  
 SCALA QUOTE 1:200

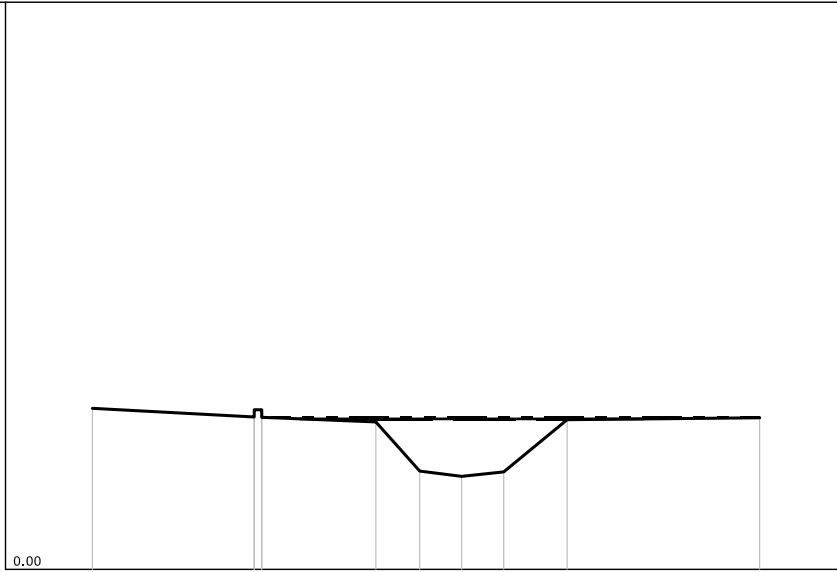

PUNTI	1	2	6	7	8	9	10	11
QUOTE [m s.l.m.]	4.26	4.03	3.90	2.60	2.46	2.58	3.96	4.01
DISTANZE PROGRESSIVE [m]	0.00	4.28	7.50	8.66	9.77	10.88	12.56	17.65
DISTANZE PARZIALI [m]		4.28	3.02	1.16	1.11	1.11	1.68	5.09

Fosso Maestra  
 SEZIONE N° 00226\_\_06

LEGENDA:

TR30 H =3.90 m. s.l.m. \_\_\_\_\_

TR200 H =3.90 m. s.l.m. \_\_\_\_\_

TR500 H =3.96 m. s.l.m. - - - - -

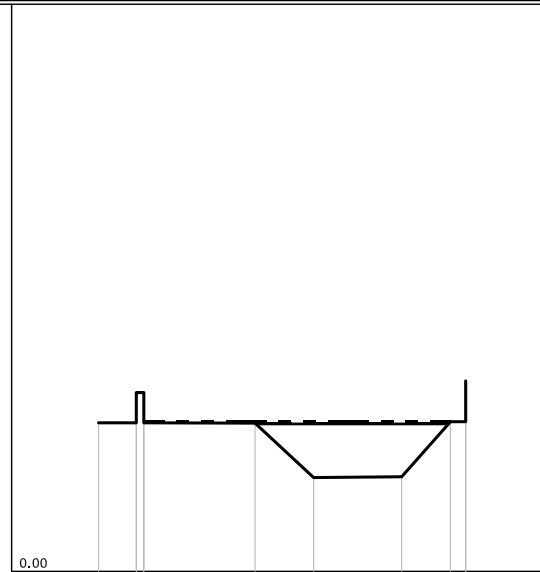



SCALA DISTANZE 1:200  
 SCALA QUOTE 1:200

PUNTI	1	2	6	7	8	9	10
QUOTE [m s.l.m.]	3.93	3.93	3.92	2.48	2.50	3.96	3.96
DISTANZE PROGRESSIVE [m]	0.00	1.00	4.14	5.69	8.02	9.31	9.71
DISTANZE PARZIALI [m]	1.00	2.94	1.55	2.33	1.29		

Fosso Maestra  
 SEZIONE N° 00224PA06

LEGENDA:

TR30 H =3.96 m. s.l.m. 

TR200 H =3.96 m. s.l.m. 

TR500 H =3.96 m. s.l.m. 

SCALA DISTANZE 1:200  
 SCALA QUOTE 1:200

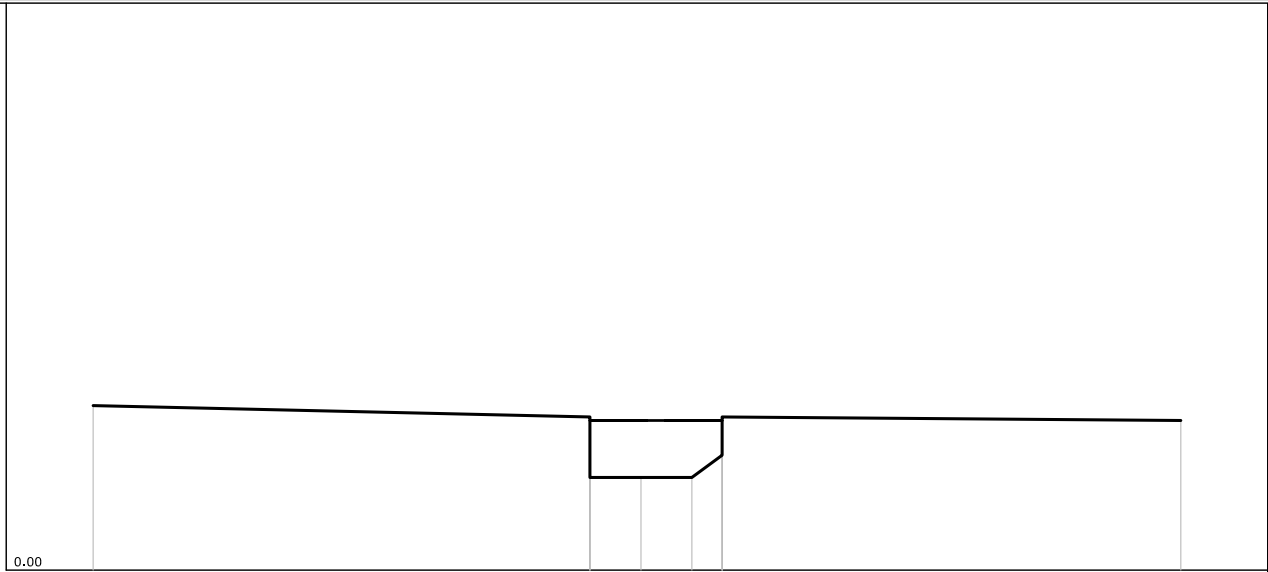



PUNTI	1	2	5	6	7	10
QUOTE [m s.l.m.]	4.35	4.05	2.45	2.45	3.04	3.96
DISTANZE PROGRESSIVE [m]	0.00	13.14	14.49	15.84	16.64	28.77
DISTANZE PARZIALI [m]		13.14	1.35	1.35		12.13

Fosso Maestra  
 SEZIONE N° 00224PB06

LEGENDA:

TR30 H =3.90 m. s.l.m. 

TR200 H =3.90 m. s.l.m. 

TR500 H =3.90 m. s.l.m. 

SCALA DISTANZE 1:200  
 SCALA QUOTE 1:200

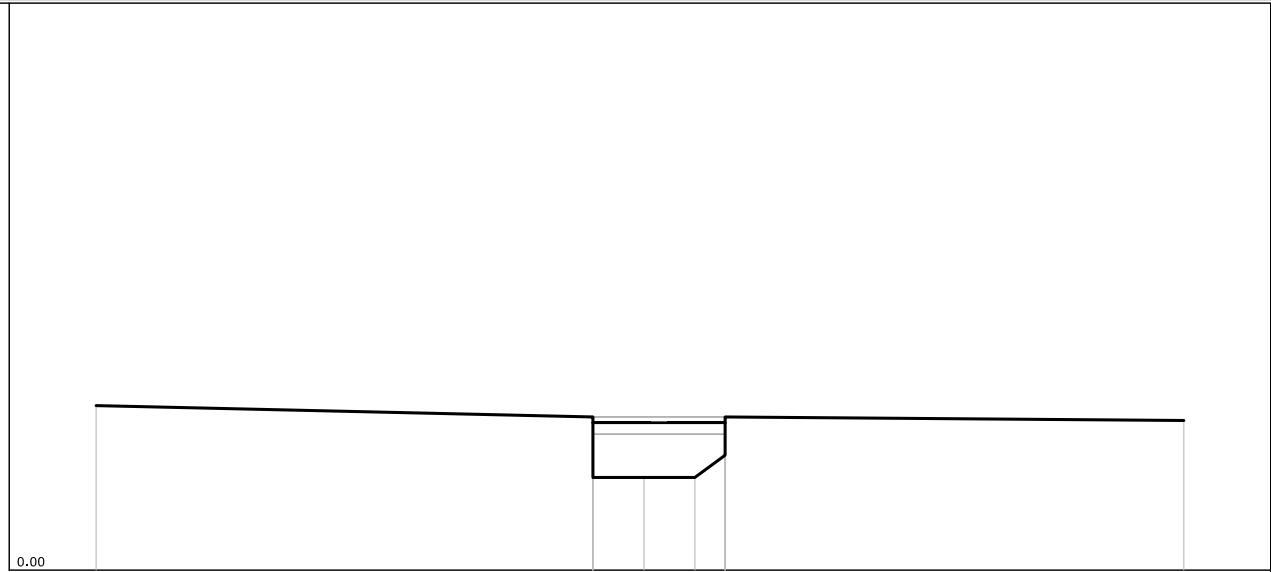



PUNTI	1	2	5	6	7	10
QUOTE [m s.l.m.]	4.35	4.05	2.45	2.45	3.04	3.96
DISTANZE PROGRESSIVE [m]	0.00	13.14	14.49	15.84	16.64	28.77
DISTANZE PARZIALI [m]		13.14	1.35	1.35		12.13

Fosso Maestra  
 SEZIONE N° 00224PC06

LEGENDA:

TR30 H =3.80 m. s.l.m. 

TR200 H =3.96 m. s.l.m. 

TR500 H =3.96 m. s.l.m. 

SCALA DISTANZE 1:200  
 SCALA QUOTE 1:200

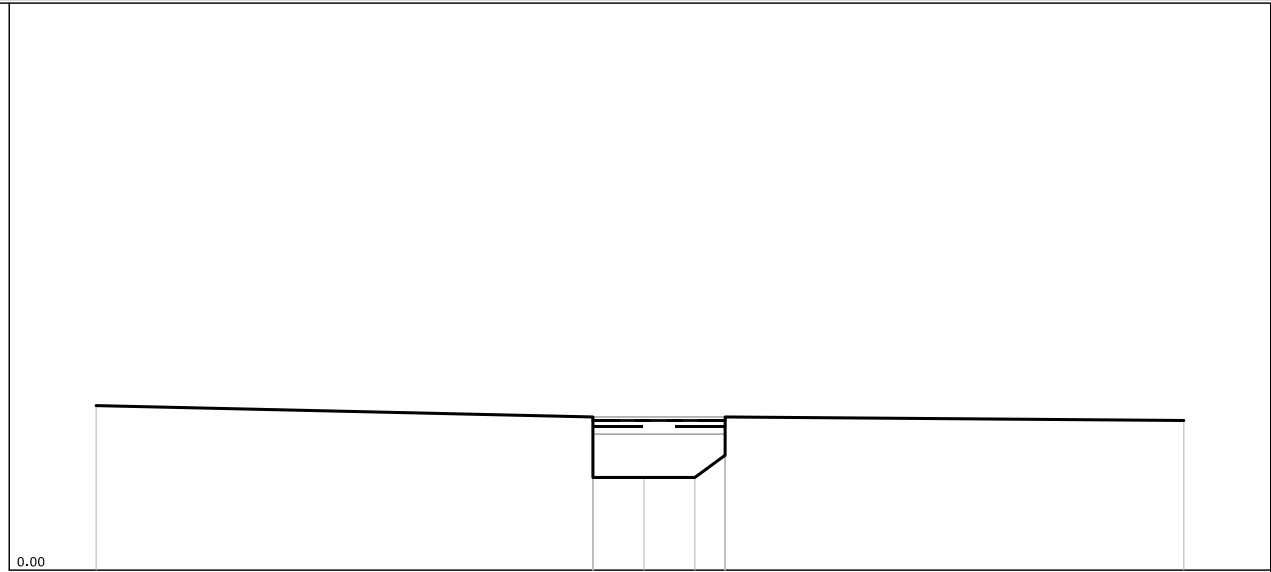



PUNTI	1		2	5	6	7		10
QUOTE [m s.l.m.]	4.35		4.05	2.45	2.45	3.04		3.96
DISTANZE PROGRESSIVE [m]	0.00		13.14	14.49	15.84	16.64		28.77
DISTANZE PARZIALI [m]		13.14		1.35	1.35		12.13	

Fosso Maestra  
 SEZIONE N° 00224PD06

LEGENDA:

TR30 H =3.80 m. s.l.m. 

TR200 H =3.88 m. s.l.m. 

TR500 H =3.88 m. s.l.m. 

SCALA DISTANZE 1:200  
 SCALA QUOTE 1:200

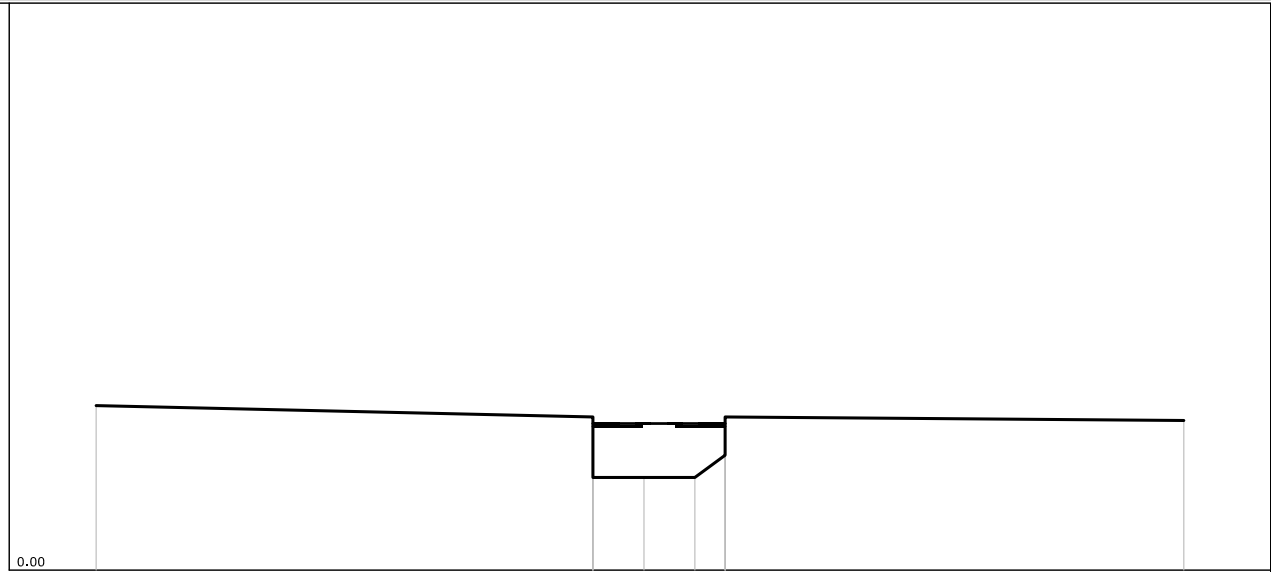



PUNTI	1	2	5	6	7	10
QUOTE [m s.l.m.]	4.35	4.05	2.45	2.45	3.04	3.96
DISTANZE PROGRESSIVE [m]	0.00	13.14	14.49	15.84	16.64	28.77
DISTANZE PARZIALI [m]		13.14	1.35	1.35		12.13



Fosso Maestra  
 SEZIONE N° 00223\_\_06

LEGENDA:

TR30 H = 3.80 m. s.l.m. 

TR200 H = 3.82 m. s.l.m. 

TR500 H = 3.83 m. s.l.m. 

SCALA DISTANZE 1:200  
 SCALA QUOTE 1:200

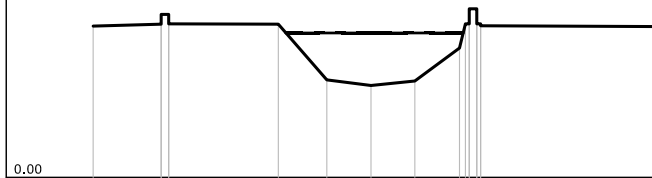

PUNTI	1	2	6	7	8	9	10.2.6	18
QUOTE [m s.l.m.]	4.00	4.05	4.05	2.58	2.43	2.55	3.42 4.06 4.06	3.99
DISTANZE PROGRESSIVE [m]	0.00	1.80	4.90	6.18	7.35	8.51	9.69 9.95 10.25	14.97
DISTANZE PARZIALI [m]		1.80	2.90	1.28	1.17	1.16	1.18	4.72

Fosso Maestra  
 SEZIONE N° 00219\_\_06

LEGENDA:

TR30 H = 3.71 m. s.l.m. ———

TR200 H = 3.71 m. s.l.m. ———

TR500 H = 3.73 m. s.l.m. - - - - -

SCALA DISTANZE 1:200  
 SCALA QUOTE 1:200

0.00

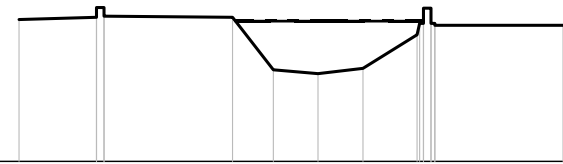



PUNTI	1	2	6	7	8	9	1014	18
QUOTE [m s.l.m.]	3.75	3.81	3.81	2.42	2.32	2.46	3.35 4.05	3.60
DISTANZE PROGRESSIVE [m]	0.00	2.05	5.65	6.73	7.91	9.10	10.53 10.90	14.39
DISTANZE PARZIALI [m]		2.05	3.40	1.08	1.18	1.19	1.43	3.39

Fosso Maestra  
SEZIONE N° 00213\_\_06

LEGENDA:

TR30 H = 3.57 m. s.l.m. 

TR200 H = 3.58 m. s.l.m. 

TR500 H = 3.59 m. s.l.m. 

SCALA DISTANZE 1:200  
SCALA QUOTE 1:200

0.00

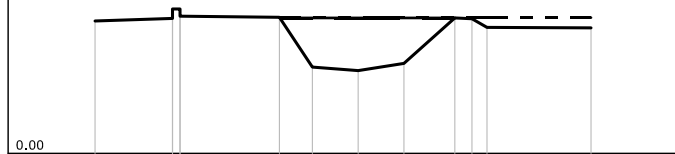



PUNTI	1	2	6	7	8	9	10	11	12	13
QUOTE [m s.l.m.]	3.50	3.57	3.60	2.28	2.19	2.38	3.58	3.56	3.33	3.32
DISTANZE PROGRESSIVE [m]	0.00	2.05	4.88	5.75	6.96	8.17	9.52	9.87	10.37	13.12
DISTANZE PARZIALI [m]		2.05	2.63	1.21	1.21	1.35			2.75	

Fosso Maestra  
SEZIONE N° 00208\_\_06

LEGENDA:

TR30 H = 3.41 m. s.l.m. 

TR200 H = 3.42 m. s.l.m. 

TR500 H = 3.42 m. s.l.m. 

SCALA DISTANZE 1:200  
SCALA QUOTE 1:200

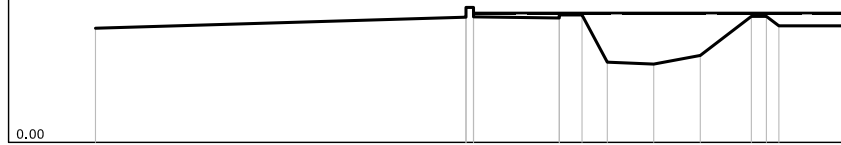



PUNTI	1	2	6	8	9	10	11	12	13	14	15
QUOTE [m s.l.m.]	3.02	3.31	3.29	3.37	2.12	2.07	2.30	3.33	3.33	3.08	3.08
DISTANZE PROGRESSIVE [m]	0.00	9.80	12.27	12.87	13.54	14.77	16.00	17.35	17.75	18.08	20.08
DISTANZE PARZIALI [m]		9.80	2.27		1.23	1.23	1.35			2.00	

Fosso Maestra  
 SEZIONE N° 00201\_\_06

LEGENDA:

TR30 H =3.19 m. s.l.m. 

TR200 H =3.19 m. s.l.m. 

TR500 H =3.19 m. s.l.m. 

SCALA DISTANZE 1:200  
 SCALA QUOTE 1:200

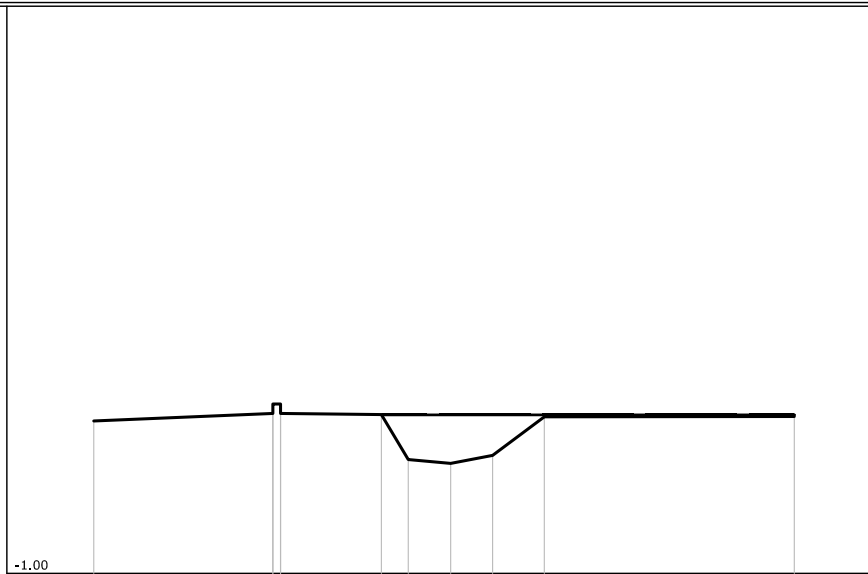

PUNTI	1	2	6	7	8	9	10	11
QUOTE [m s.l.m.]	3.03	3.23	3.20	2.01	1.91	2.12	3.14	3.15
DISTANZE PROGRESSIVE [m]	0.00	4.74	7.61	8.32	9.44	10.55	11.92	18.53
DISTANZE PARZIALI [m]		4.74	2.67	1.12	1.11	1.37	6.61	

Fosso Maestra  
SEZIONE N° 00195\_\_06

LEGENDA:

- TR30 H = 3.03 m. s.l.m.
- TR200 H = 3.04 m. s.l.m.
- TR500 H = 3.04 m. s.l.m.

SCALA DISTANZE 1:200  
SCALA QUOTE 1:200

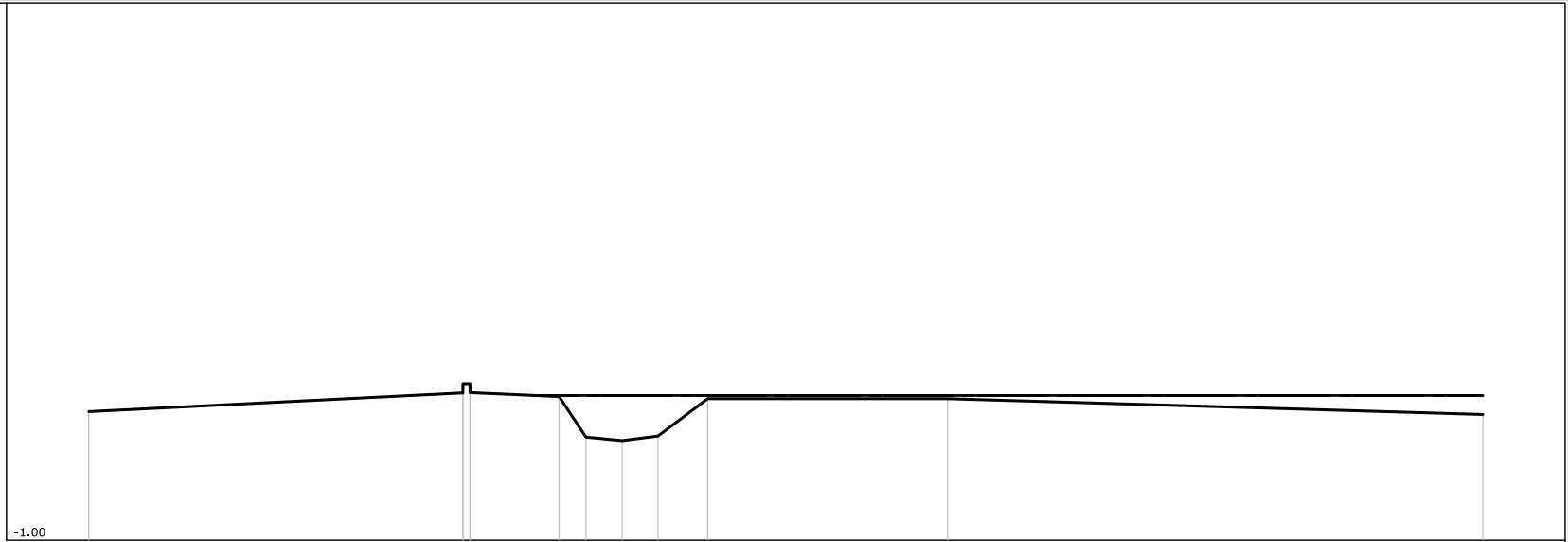

PUNTI	1	2	6	7	8	9	10	11	12
QUOTE [m s.l.m.]	2.59	3.11	3.01	1.88	1.78	1.91	2.95	2.95	2.51
DISTANZE PROGRESSIVE [m]	0.00	10.45	13.14	13.89	14.90	15.90	17.29	23.99	38.94
DISTANZE PARZIALI [m]		10.45	2.49	1.01	1.00	1.39	6.70	14.95	

Fosso Maestra  
 SEZIONE N° 00190\_\_06

LEGENDA:

TR30 H =2.94 m. s.l.m. ————

TR200 H =2.95 m. s.l.m. —————

TR500 H =2.95 m. s.l.m. - - - - -

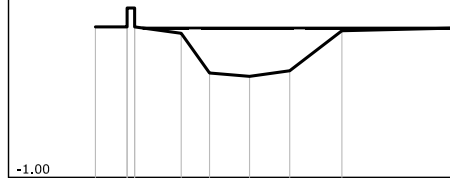

SCALA DISTANZE 1:200  
 SCALA QUOTE 1:200

PUNTI	1	2	6	7	8	9	10	11
QUOTE [m s.l.m.]	2.98	2.98	2.81	1.76	1.67	1.82	2.88	2.95
DISTANZE PROGRESSIVE [m]	0.00	0.84	2.27	3.02	4.08	5.14	6.52	9.56
DISTANZE PARZIALI [m]		0.84	1.23	1.06	1.06	1.38	3.04	

Fosso Maestra  
SEZIONE N° 00184\_\_06

LEGENDA:

TR30 H =2.85 m. s.l.m. 

TR200 H =2.90 m. s.l.m. 

TR500 H =2.91 m. s.l.m. 

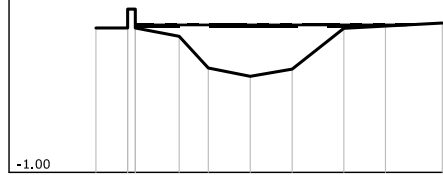

SCALA DISTANZE 1:200  
SCALA QUOTE 1:200

PUNTI	1	2	6	7	8	9	10	11	12
QUOTE [m s.l.m.]	2.82	2.82	2.60	1.76	1.54	1.73	2.81	2.87	2.95
DISTANZE PROGRESSIVE [m]	0.00	0.84	2.20	2.97	4.08	5.19	6.56	7.66	9.16
DISTANZE PARZIALI [m]		1.16	1.11	1.11	1.37	1.10	1.50		



Fosso Maestra  
 SEZIONE N° 00179\_\_06

LEGENDA:

TR30 H = 2.77 m. s.l.m. 

TR200 H = 2.91 m. s.l.m. 

TR500 H = 2.93 m. s.l.m. 

SCALA DISTANZE 1:200  
 SCALA QUOTE 1:200

-1.00

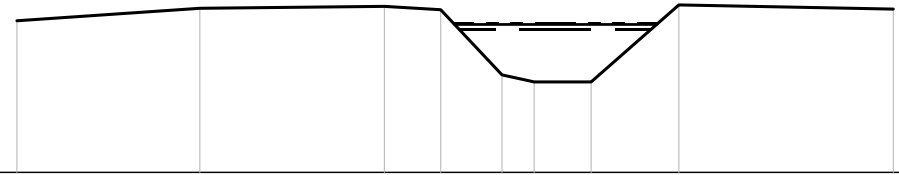

PUNTI	1	2	3	4	5	6	7	8	9
QUOTE [m s.l.m.]	3.01	3.34	3.39	3.30	1.58	1.39	1.39	3.43	3.32
DISTANZE PROGRESSIVE [m]	0.00	4.84	9.72	11.21	12.83	13.68	15.19	17.51	23.18
DISTANZE PARZIALI [m]		4.84	4.88	1.49	1.62	1.51	2.32	5.67	

Fosso Maestra  
 SEZIONE N° 00178PA06

LEGENDA:

TR30 H = 2.76 m. s.l.m. ———

TR200 H = 2.91 m. s.l.m. ———

TR500 H = 2.93 m. s.l.m. - - - - -

SCALA DISTANZE 1:200  
 SCALA QUOTE 1:200

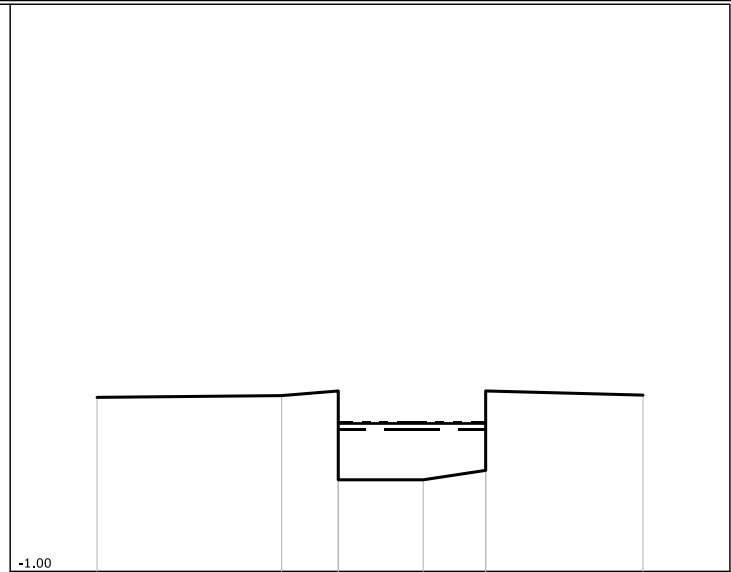

PUNTI	1	2	3	5	6	8
QUOTE [m s.l.m.]	3.60	3.65	3.77	1.42	1.67	3.66
DISTANZE PROGRESSIVE [m]	0.00	4.88	6.38	8.63	10.28	14.44
DISTANZE PARZIALI [m]		4.88	1.50	2.25	1.65	4.16

Fosso Maestra  
 SEZIONE N° 00178PB06

LEGENDA:

TR30 H = 2.76 m. s.l.m. 

TR200 H = 2.90 m. s.l.m. 

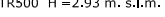
TR500 H = 2.93 m. s.l.m. 

SCALA DISTANZE 1:200  
 SCALA QUOTE 1:200

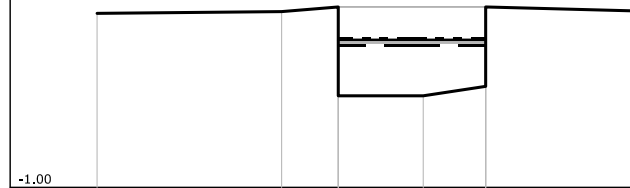

PUNTI	1	2	3	6	7	10
QUOTE [m s.l.m.]	3.60	3.65	3.77	1.42	1.67	3.66
DISTANZE PROGRESSIVE [m]	0.00	4.88	6.38	8.63	10.28	14.44
DISTANZE PARZIALI [m]		4.88	1.50	2.25	1.65	4.16

Fosso Maestra  
 SEZIONE N° 00178PC06

LEGENDA:

TR30 H = 2.73 m. s.l.m. ———

TR200 H = 2.88 m. s.l.m. ———

TR500 H = 2.93 m. s.l.m. - - - - -

SCALA DISTANZE 1:200  
 SCALA QUOTE 1:200

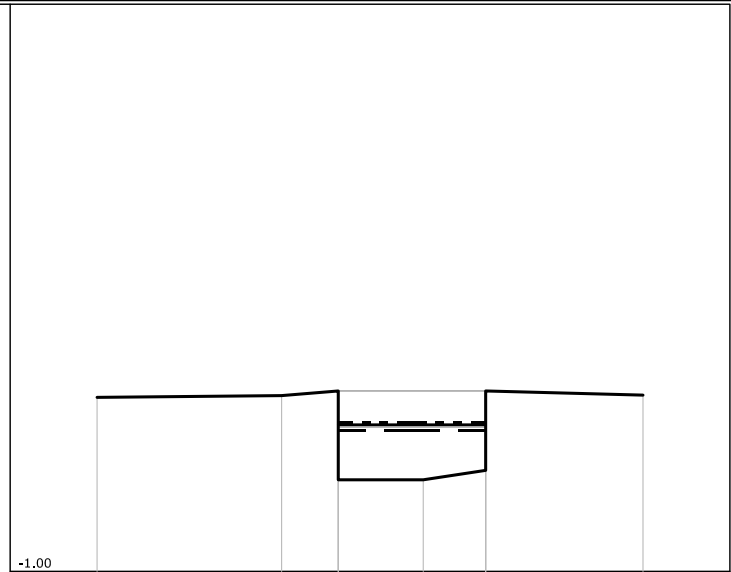

PUNTI	1	2	3	6	7	10
QUOTE [m s.l.m.]	3.60	3.65	3.77	1.42	1.67	3.66
DISTANZE PROGRESSIVE [m]	0.00	4.88	6.38	8.63	10.28	14.44
DISTANZE PARZIALI [m]		4.88	1.50	2.25	1.65	4.16

Fosso Maestra  
 SEZIONE N° 00178PD06

LEGENDA:

TR30 H = 2.72 m. s.l.m. ————

TR200 H = 2.88 m. s.l.m. —————

TR500 H = 2.93 m. s.l.m. - - - - -

SCALA DISTANZE 1:200  
 SCALA QUOTE 1:200

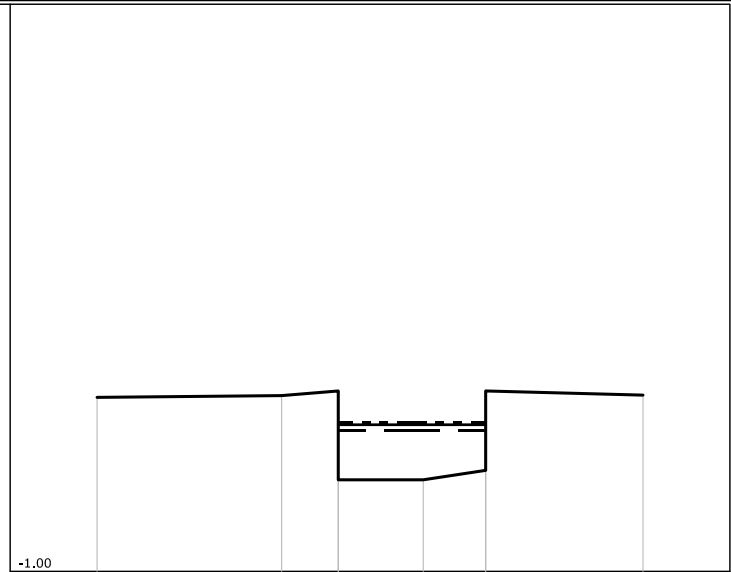

PUNTI	1	2	3	5	6	8
QUOTE [m s.l.m.]	3.60	3.65	3.77	1.42	1.67	3.66
DISTANZE PROGRESSIVE [m]	0.00	4.88	6.38	8.63	10.28	14.44
DISTANZE PARZIALI [m]		4.88	1.50	2.25	1.65	4.16

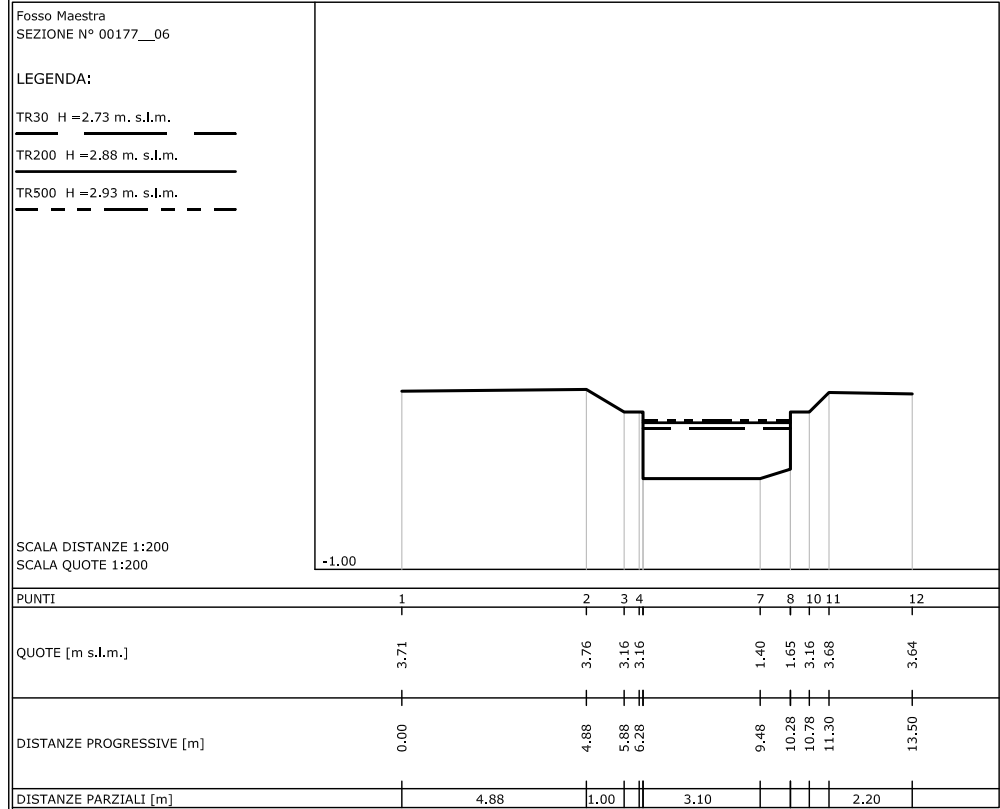

Fosso Maestra  
 SEZIONE N° 00176PA06

LEGENDA:

TR30 H =2.72 m. s.l.m.

TR200 H =2.88 m. s.l.m.

TR500 H =2.93 m. s.l.m.

SCALA DISTANZE 1:200  
 SCALA QUOTE 1:200

-1.00

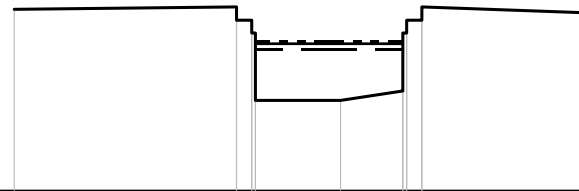

PUNTI	1	2	4	8	9	13	15
QUOTE [m s.l.m.]	3.79	3.85	3.50	1.38	1.63	3.50	3.69
DISTANZE PROGRESSIVE [m]	0.00	5.88	6.28	8.63	10.28	10.78	15.28
DISTANZE PARZIALI [m]		5.88	2.25	1.65		4.50	

Fosso Maestra  
 SEZIONE N° 00176PB06

LEGENDA:

TR30 H =2.72 m. s.l.m. \_\_\_\_\_

TR200 H =2.88 m. s.l.m. \_\_\_\_\_

TR500 H =2.93 m. s.l.m. - - - - -

SCALA DISTANZE 1:200  
 SCALA QUOTE 1:200

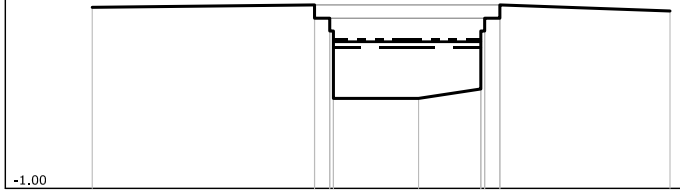

PUNTI	1	2	4	8	9	13	15
QUOTE [m s.l.m.]	3.79	3.85	3.50	1.38	1.63	3.50	3.69
DISTANZE PROGRESSIVE [m]	0.00	5.88	6.28	8.63	10.28	10.78	15.28
DISTANZE PARZIALI [m]		5.88	2.25	1.65		4.50	



Fosso Maestra  
 SEZIONE N° 00176PC06

LEGENDA:

TR30 H =2.69 m. s.l.m.

TR200 H =2.86 m. s.l.m.

TR500 H =2.92 m. s.l.m.

SCALA DISTANZE 1:200  
 SCALA QUOTE 1:200

-1.00

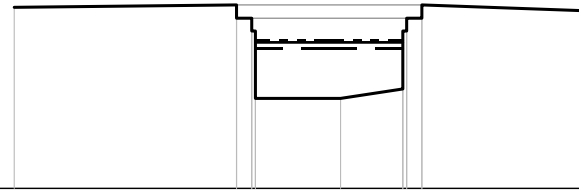

PUNTI	1	2	4	8	9	13	15
QUOTE [m s.l.m.]	3.79	3.85	3.50	1.38	1.63	3.50	3.69
DISTANZE PROGRESSIVE [m]	0.00	5.88	6.28	8.63	10.28	10.78	15.28
DISTANZE PARZIALI [m]		5.88	2.25	1.65		4.50	

Fosso Maestra  
 SEZIONE N° 00176PD06

LEGENDA:

TR30 H =2.69 m. s.l.m.

TR200 H =2.86 m. s.l.m.

TR500 H =2.92 m. s.l.m.

SCALA DISTANZE 1:200  
 SCALA QUOTE 1:200

-1.00

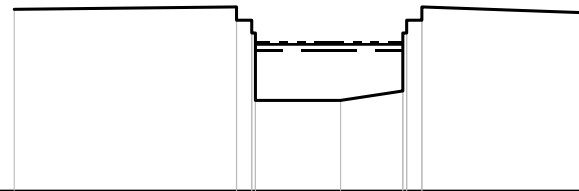

PUNTI	1	2	4	8	9	13	15
QUOTE [m s.l.m.]	3.79	3.85	3.50	1.38	1.63	3.50	3.69
DISTANZE PROGRESSIVE [m]	0.00	5.88	6.28	8.63	10.28	10.78	15.28
DISTANZE PARZIALI [m]		5.88	2.25	1.65	4.50		

Fosso Maestra  
 SEZIONE N° 00175\_\_06

LEGENDA:

- TR30 H = 2.69 m. s.l.m.
- TR200 H = 2.86 m. s.l.m.
- TR500 H = 2.92 m. s.l.m.

SCALA DISTANZE 1:200  
 SCALA QUOTE 1:200

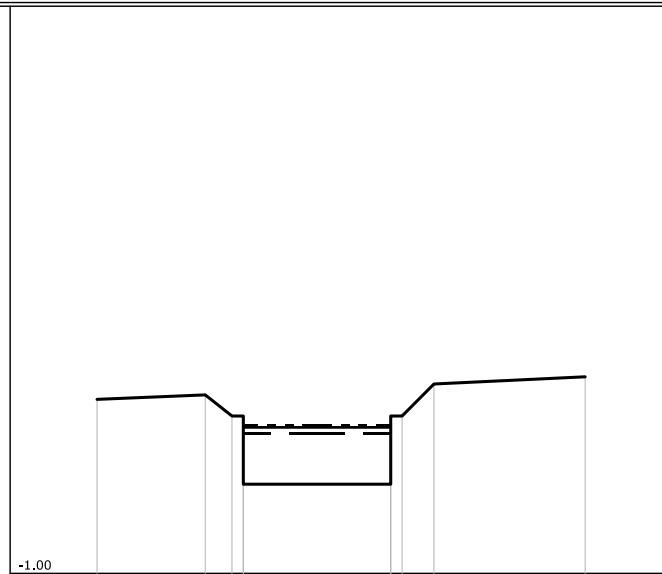

PUNTI	1	2	3	4	6	8	9	10
QUOTE [m s.l.m.]	3.60	3.72	3.16	3.16	1.36	3.16	4.01	4.20
DISTANZE PROGRESSIVE [m]	0.00	2.86	3.57	3.87	7.77	8.07	8.91	12.91
DISTANZE PARZIALI [m]		2.86			3.90			4.00

Fosso Maestra  
 SEZIONE N° 00174PA06

LEGENDA:

TR30 H = 2,68 m. s.l.m. ———

TR200 H = 2,86 m. s.l.m. ———

TR500 H = 2,92 m. s.l.m. - - - - -

SCALA DISTANZE 1:200  
 SCALA QUOTE 1:200

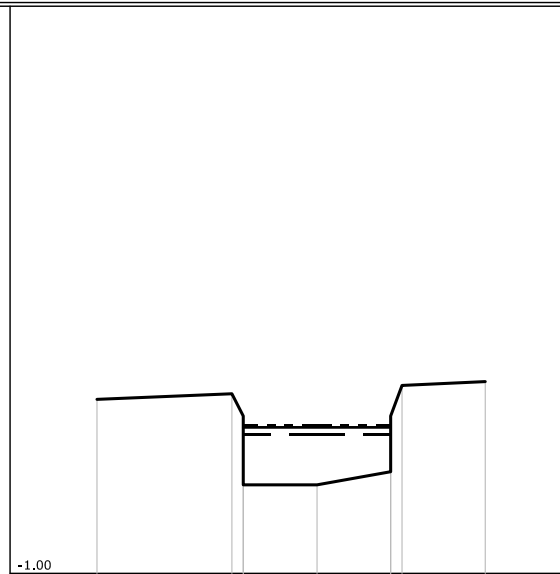



PUNTI	1	2 3	5	6 8	9
QUOTE [m s.l.m.]	3.60	3.75 3.16	1.34	1.69 3.97	4.07
DISTANZE PROGRESSIVE [m]	0.00	3.57 3.87	5.82	7.77 8.07	10.27
DISTANZE PARZIALI [m]		3.57	1.95	1.95	2.20

Fosso Maestra  
 SEZIONE N° 00174PB06

LEGENDA:

TR30 H = 2,68 m. s.l.m. 

TR200 H = 2,86 m. s.l.m. 

TR500 H = 2,92 m. s.l.m. 

SCALA DISTANZE 1:200  
 SCALA QUOTE 1:200

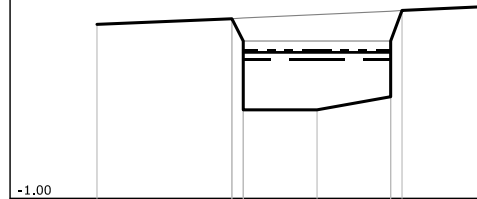



PUNTI	1	2.4	6	7.9	10
QUOTE [m s.l.m.]	3.60	3.75 3.16	1.34	1.69 3.97	4.07
DISTANZE PROGRESSIVE [m]	0.00	3.57 3.87	5.82	7.77 8.07	10.27
DISTANZE PARZIALI [m]		3.57	1.95	1.95	2.20

Fosso Maestra  
 SEZIONE N° 00174PC06

LEGENDA:

TR30 H = 2,65 m. s.l.m. 

TR200 H = 2,84 m. s.l.m. 

TR500 H = 2,93 m. s.l.m. 

SCALA DISTANZE 1:200  
 SCALA QUOTE 1:200

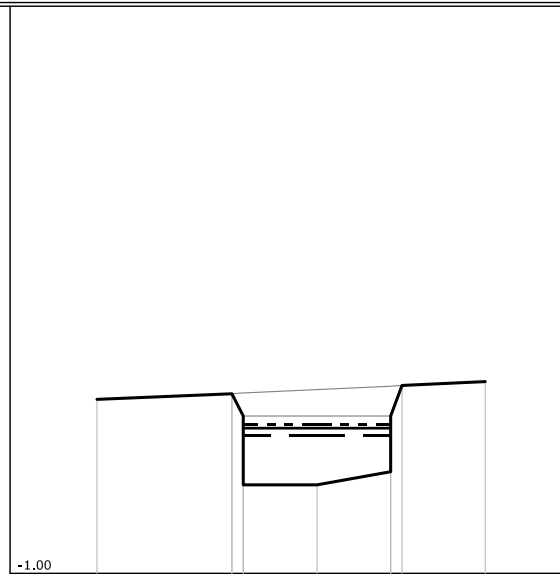

PUNTI	1	2.4	6	7.9	10
QUOTE [m s.l.m.]	3.60	3.75 3.16	1.34	1.69 3.97	4.07
DISTANZE PROGRESSIVE [m]	0.00	3.57 3.87	5.82	7.77 8.07	10.27
DISTANZE PARZIALI [m]		3.57	1.95	1.95	2.20

Fosso Maestra  
 SEZIONE N° 00174PD06

LEGENDA:

TR30 H = 2,65 m. s.l.m. ———

TR200 H = 2,84 m. s.l.m. ———

TR500 H = 2,93 m. s.l.m. - - - - -

SCALA DISTANZE 1:200  
 SCALA QUOTE 1:200

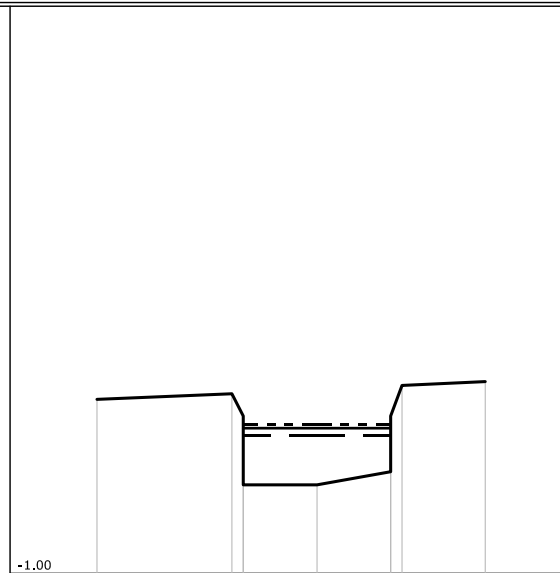

PUNTI	1	2 3	5	6 8	9
QUOTE [m s.l.m.]	3.60	3.75 3.16	1.34	1.69 3.97	4.07
DISTANZE PROGRESSIVE [m]	0.00	3.57 3.87	5.82	7.77 8.07	10.27
DISTANZE PARZIALI [m]		3.57	1.95	1.95	2.20

Fosso Maestra  
 SEZIONE N° 00173\_\_06

LEGENDA:

- TR30 H =2.63 m. s.l.m.
- TR200 H =2.84 m. s.l.m.
- TR500 H =2.93 m. s.l.m.

SCALA DISTANZE 1:200  
 SCALA QUOTE 1:200

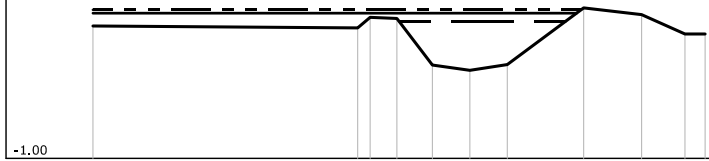

PUNTI	1	2	3	4	5	6	7	8	9	10	11
QUOTE [m s.l.m.]	2.50		2.45 2.73	2.70	1.47	1.33	1.48	2.98	2.80	2.29	2.29
DISTANZE PROGRESSIVE [m]	0.00		7.00 7.33	8.04	8.88	9.97	10.96	12.98	14.51	15.66	16.19
DISTANZE PARZIALI [m]		7.00				0.99	0.99	2.02	1.53	1.15	



Fosso Maestra  
SEZIONE N° 00171\_\_06

LEGENDA:

TR30 H =2.60 m. s.l.m. ———

TR200 H =2.81 m. s.l.m. ———

TR500 H =2.93 m. s.l.m. - - - - -

SCALA DISTANZE 1:200  
SCALA QUOTE 1:200

-1.00

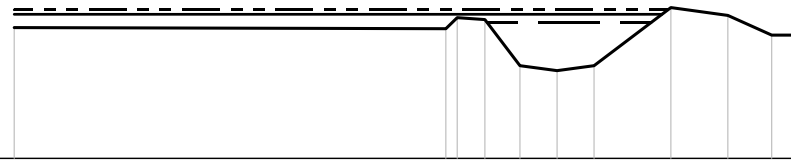

PUNTI	1					2	3	4	5	6	7	8	9	10	11
QUOTE [m s.l.m.]	2.46					2.43	2.72	2.67	1.45	1.32	1.45	2.99	2.78	2.26	2.26
DISTANZE PROGRESSIVE [m]	0.00					11.42	11.72	12.45	13.38	14.36	15.34	17.37	18.88	20.04	20.57
DISTANZE PARZIALI [m]		11.42							0.98	0.98	2.03	1.51	1.16		

Fosso Maestra  
 SEZIONE N° 00170PA06

LEGENDA:

TR30 H =2.59 m. s.l.m.

TR200 H =2.79 m. s.l.m.

TR500 H =2.93 m. s.l.m.

SCALA DISTANZE 1:200  
 SCALA QUOTE 1:200

-1.00

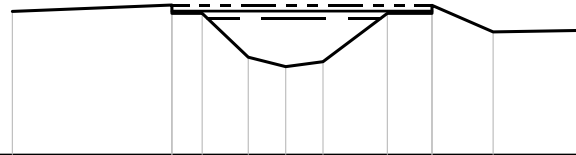

PUNTI	1	2	4	5	6	7	8	9	11	12
QUOTE [m s.l.m.]	2.78	2.95	2.73	1.57	1.32	1.45	2.73	2.73	2.24	2.28
DISTANZE PROGRESSIVE [m]	0.00	4.22	5.02	6.24	7.23	8.22	9.92	11.10	12.72	15.22
DISTANZE PARZIALI [m]		4.22	1.22	0.99	0.99	1.70	1.18	1.62	2.50	

Fosso Maestra  
 SEZIONE N° 00170PB06

LEGENDA:

TR30 H =2.58 m. s.l.m. 

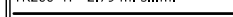
TR200 H =2.79 m. s.l.m. 

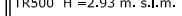
TR500 H =2.93 m. s.l.m. 

SCALA DISTANZE 1:200  
 SCALA QUOTE 1:200

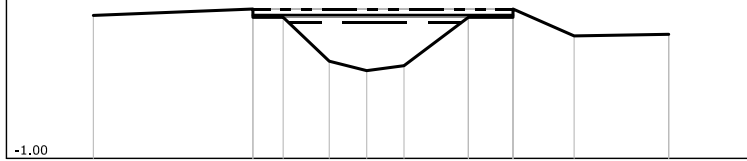

PUNTI	1	2	4	5	6	7	8	10	13	14
QUOTE [m s.l.m.]	2.78	2.95	2.73	1.57	1.32	1.45	2.73	2.73	2.24	2.28
DISTANZE PROGRESSIVE [m]	0.00	4.22	5.02	6.24	7.23	8.22	9.92	11.10	12.72	15.22
DISTANZE PARZIALI [m]		4.22	1.22	0.99	0.99	1.70	1.18	1.62	2.50	

Fosso Maestra  
 SEZIONE N° 00170PC06

LEGENDA:

TR30 H =2.54 m. s.l.m. ———

TR200 H =2.77 m. s.l.m. ———

TR500 H =2.91 m. s.l.m. - - - - -

SCALA DISTANZE 1:200  
 SCALA QUOTE 1:200

-1.00

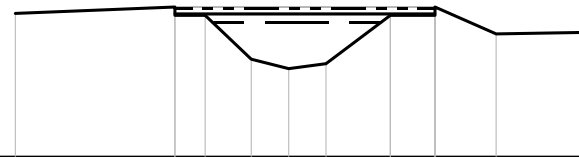

PUNTI	1	2	4	5	6	7	8	10	13	14
QUOTE [m s.l.m.]	2.78	2.95	2.73	1.57	1.32	1.45	2.73	2.73	2.24	2.28
DISTANZE PROGRESSIVE [m]	0.00	4.22	5.02	6.24	7.23	8.22	9.92	11.10	12.72	15.22
DISTANZE PARZIALI [m]		4.22	1.22	0.99	0.99	1.70	1.18	1.62	2.50	

Fosso Maestra  
 SEZIONE N° 00170PD06

LEGENDA:

TR30 H =2.54 m. s.l.m. ———

TR200 H =2.77 m. s.l.m. ———

TR500 H =2.91 m. s.l.m. - - - - -

SCALA DISTANZE 1:200  
 SCALA QUOTE 1:200

-1.00

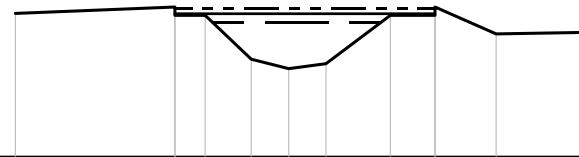

PUNTI	1	2	4	5	6	7	8	9	11	12
QUOTE [m s.l.m.]	2.78	2.95	2.73	1.57	1.32	1.45	2.73	2.73	2.24	2.28
DISTANZE PROGRESSIVE [m]	0.00	4.22	5.02	6.24	7.23	8.22	9.92	11.10	12.72	15.22
DISTANZE PARZIALI [m]		4.22	1.22	0.99	0.99	1.70	1.18	1.62	2.50	

Fosso Maestra  
 SEZIONE N° 00168\_\_06

LEGENDA:

TR30 H =2.52 m. s.l.m. \_\_\_\_\_

TR200 H =2.77 m. s.l.m. \_\_\_\_\_

TR500 H =2.91 m. s.l.m. - - - - -

SCALA DISTANZE 1:200  
 SCALA QUOTE 1:200

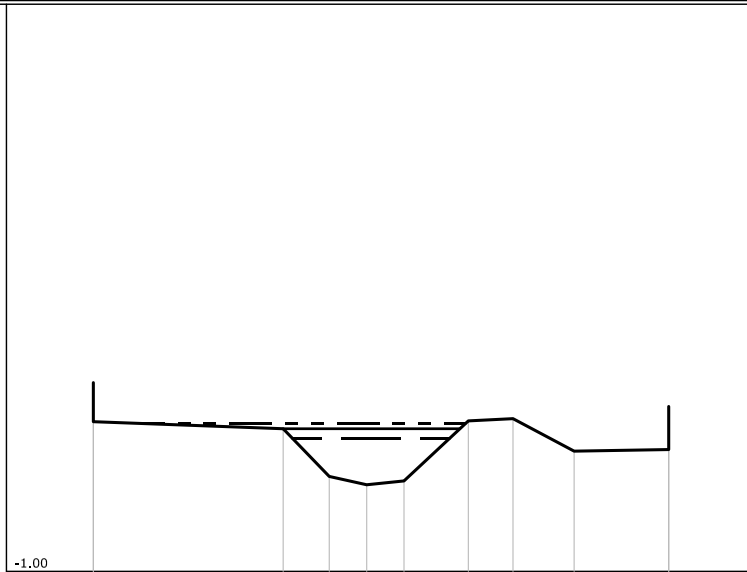



PUNTI	1	3	4	5	6	7	8	9	10
QUOTE [m s.l.m.]	3.99	2.77	1.51	1.29	1.39	2.98	3.04	2.18	2.22
DISTANZE PROGRESSIVE [m]	0.00	5.02	6.24	7.23	8.22	9.92	11.10	12.72	15.22
DISTANZE PARZIALI [m]		5.02	1.22	0.99	0.99	1.70	1.18	1.62	2.50

Fosso Maestra  
 SEZIONE N° 00164\_\_06

LEGENDA:

TR30 H = 2.47 m. s.l.m. 

TR200 H = 2.76 m. s.l.m. 

TR500 H = 2.89 m. s.l.m. 

SCALA DISTANZE 1:200  
 SCALA QUOTE 1:200

-1.00

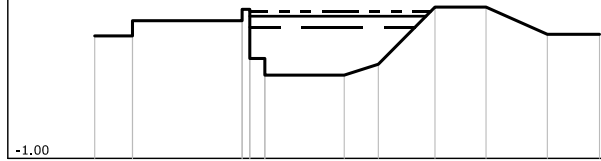

PUNTI	1	2	4	8	10	11	12	13	14	15
QUOTE [m s.l.m.]	2.24	2.24	2.64	1.64	1.20	1.49	3.00	3.00	2.28	2.28
DISTANZE PROGRESSIVE [m]	0.00	1.00	3.90	4.50	6.60	7.50	9.00	10.35	11.97	13.35
DISTANZE PARZIALI [m]	1.00	2.90	2.10	2.10	1.50	1.35	1.62	1.38		

Fosso Maestra  
 SEZIONE N° 00163PA06

LEGENDA:

TR30 H = 2.47 m. s.l.m. \_\_\_\_\_

TR200 H = 2.76 m. s.l.m. \_\_\_\_\_

TR500 H = 2.89 m. s.l.m. - - - - -

SCALA DISTANZE 1:200  
 SCALA QUOTE 1:200

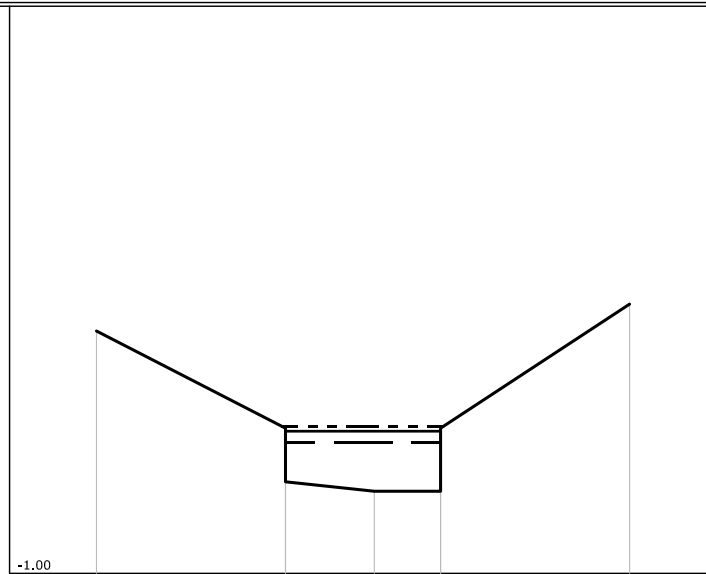

PUNTI	1	2	4	5	7
QUOTE [m s.l.m.]	5.41	2.84	1.17	1.17	6.12
DISTANZE PROGRESSIVE [m]	0.00	5.00	7.35	9.10	14.10
DISTANZE PARZIALI [m]		5.00	2.35	1.75	5.00



Fosso Maestra  
 SEZIONE N° 00163PB06

LEGENDA:

- TR30 H = 2.47 m. s.l.m.
- TR200 H = 2.76 m. s.l.m.
- TR500 H = 2.89 m. s.l.m.

SCALA DISTANZE 1:200  
 SCALA QUOTE 1:200

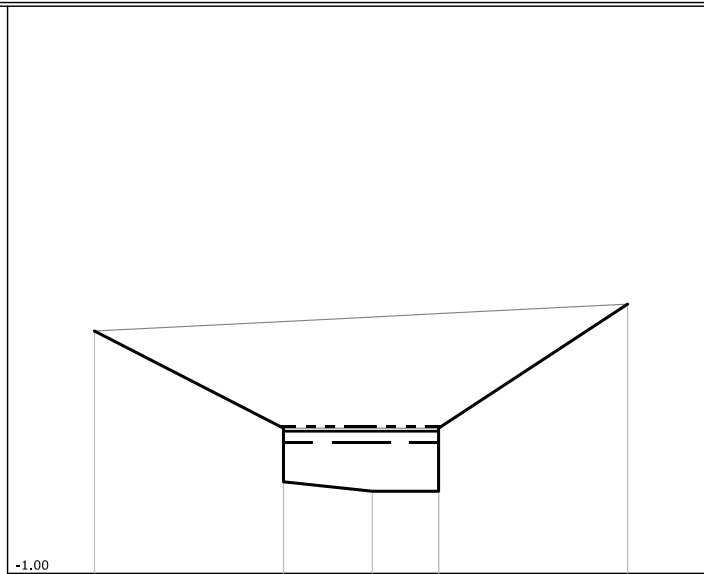

PUNTI	1	2	4	5	8
QUOTE [m s.l.m.]	5.41	2.84	1.17	1.17	6.12
DISTANZE PROGRESSIVE [m]	0.00	5.00	7.35	9.10	14.10
DISTANZE PARZIALI [m]		5.00	2.35	1.75	5.00

Fosso Maestra  
 SEZIONE N° 00163PC06

LEGENDA:

- TR30 H = 2.44 m. s.l.m.
- TR200 H = 2.74 m. s.l.m.
- TR500 H = 2.87 m. s.l.m.

SCALA DISTANZE 1:200  
 SCALA QUOTE 1:200

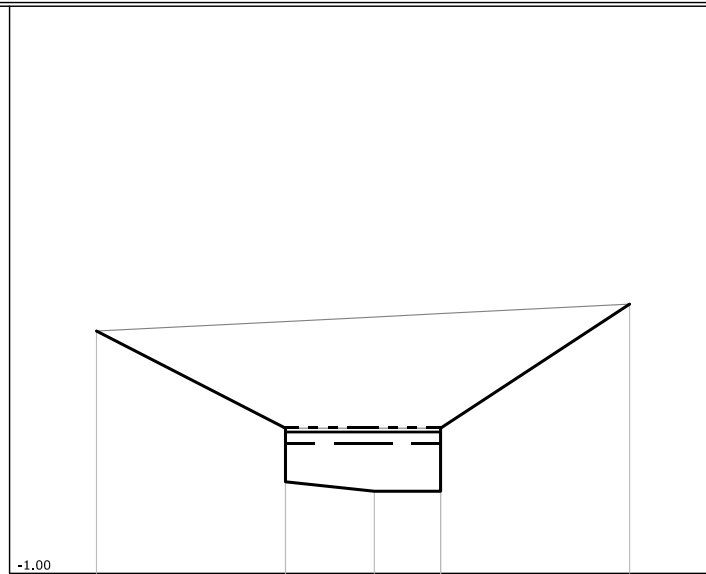

PUNTI	1	2	4	5	8
QUOTE [m s.l.m.]	5.41	2.84	1.17	1.17	6.12
DISTANZE PROGRESSIVE [m]	0.00	5.00	7.35	9.10	14.10
DISTANZE PARZIALI [m]		5.00	2.35	1.75	5.00

Fosso Maestra  
 SEZIONE N° 00163PD06

LEGENDA:

TR30 H = 2.44 m. s.l.m. ———

TR200 H = 2.74 m. s.l.m. ———

TR500 H = 2.87 m. s.l.m. - - - - -

SCALA DISTANZE 1:200  
 SCALA QUOTE 1:200

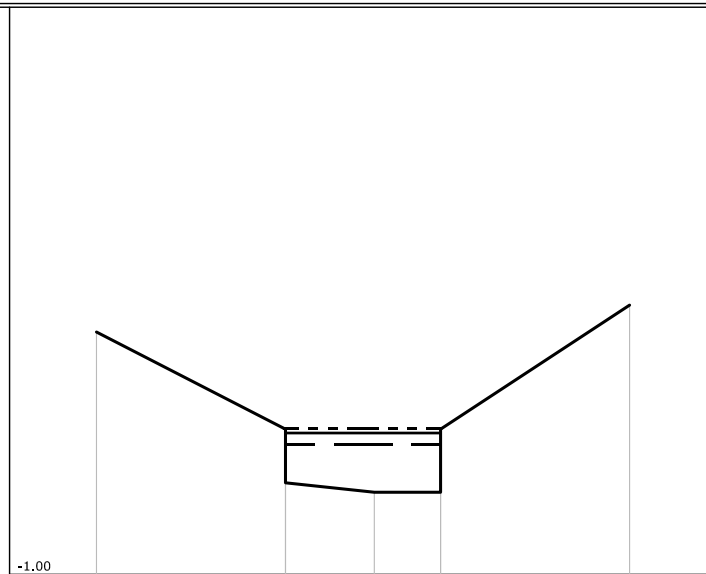

PUNTI	1	2	4	5	7
QUOTE [m s.l.m.]	5.41	2.84	1.17	1.17	6.12
DISTANZE PROGRESSIVE [m]	0.00	5.00	7.35	9.10	14.10
DISTANZE PARZIALI [m]		5.00	2.35	1.75	5.00

Fosso Maestra  
 SEZIONE N° 00156PA06

LEGENDA:

TR30 H =2.47 m. s.l.m. ———

TR200 H =2.75 m. s.l.m. ———

TR500 H =2.87 m. s.l.m. - - - - -

SCALA DISTANZE 1:200  
 SCALA QUOTE 1:200

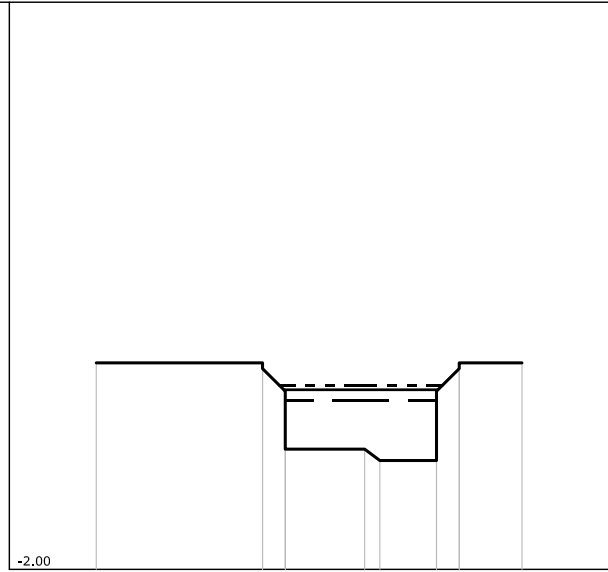

PUNTI	1	2	4	6	7	8	10	12
QUOTE [m s.l.m.]	3.46	3.46	2.71	1.18	0.88	0.88	3.31	3.46
DISTANZE PROGRESSIVE [m]	0.00	4.40	5.00	7.10	7.50	9.00	9.60	11.26
DISTANZE PARZIALI [m]		4.40		2.10		1.50		1.66

Fosso Maestra  
 SEZIONE N° 00156PB06

LEGENDA:

TR30 H = 2.45 m. s.l.m. 

TR200 H = 2.74 m. s.l.m. 

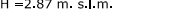
TR500 H = 2.87 m. s.l.m. 

SCALA DISTANZE 1:200  
 SCALA QUOTE 1:200

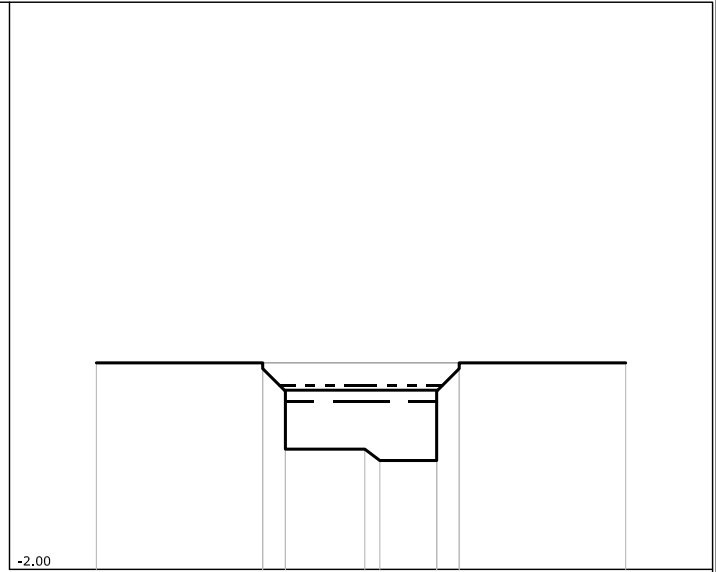

PUNTI	1	2	4	6	7	8	11	13
QUOTE [m s.l.m.]	3.46	3.46	2.71	1.18	0.88	0.88	3.31	3.46
DISTANZE PROGRESSIVE [m]	0.00	4.40	5.00	7.10	7.90	9.00	9.60	14.00
DISTANZE PARZIALI [m]		4.40		2.10		1.50		4.40

Fosso Maestra  
SEZIONE N° 00156PC06

LEGENDA:

TR30 H = 2.42 m. s.l.m. 

TR200 H = 2.72 m. s.l.m. 

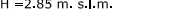
TR500 H = 2.85 m. s.l.m. 

SCALA DISTANZE 1:200  
SCALA QUOTE 1:200

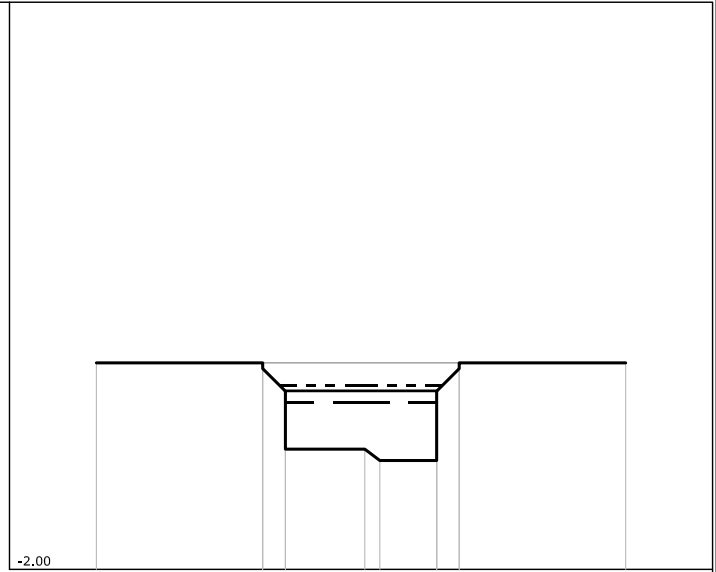



PUNTI	1	2	4	6	7	8	11	13
QUOTE [m s.l.m.]	3.46	3.46	2.71	1.18	0.88	0.88	3.31	3.46
DISTANZE PROGRESSIVE [m]	0.00	4.40	5.00	7.10	7.50	9.00	9.60	14.00
DISTANZE PARZIALI [m]		4.40		2.10		1.50		4.40

Fosso Maestra  
 SEZIONE N° 00156PD06

LEGENDA:

TR30 H =2.39 m. s.l.m. 

TR200 H =2.72 m. s.l.m. 

TR500 H =2.85 m. s.l.m. 

SCALA DISTANZE 1:200  
 SCALA QUOTE 1:200

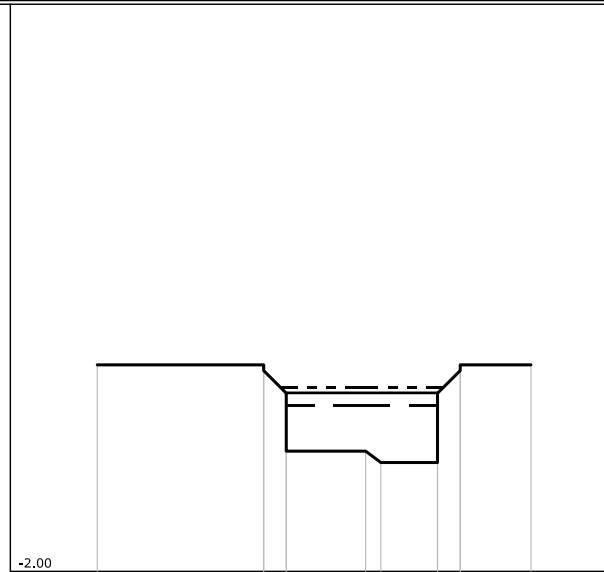

PUNTI	1	2	4	6	7	8	10	12
QUOTE [m s.l.m.]	3.46	3.46	2.71	1.18	0.88	0.88	3.31	3.46
DISTANZE PROGRESSIVE [m]	0.00	4.40	5.00	7.10	7.50	9.00	9.60	11.47
DISTANZE PARZIALI [m]		4.40		2.10		1.50		1.87

Fosso Maestra  
 SEZIONE N° 00154\_06

LEGENDA:

TR30 H =2.44 m. s.l.m. ————

TR200 H =2.72 m. s.l.m. —————

TR500 H =2.85 m. s.l.m. - - - - -

SCALA DISTANZE 1:200  
 SCALA QUOTE 1:200

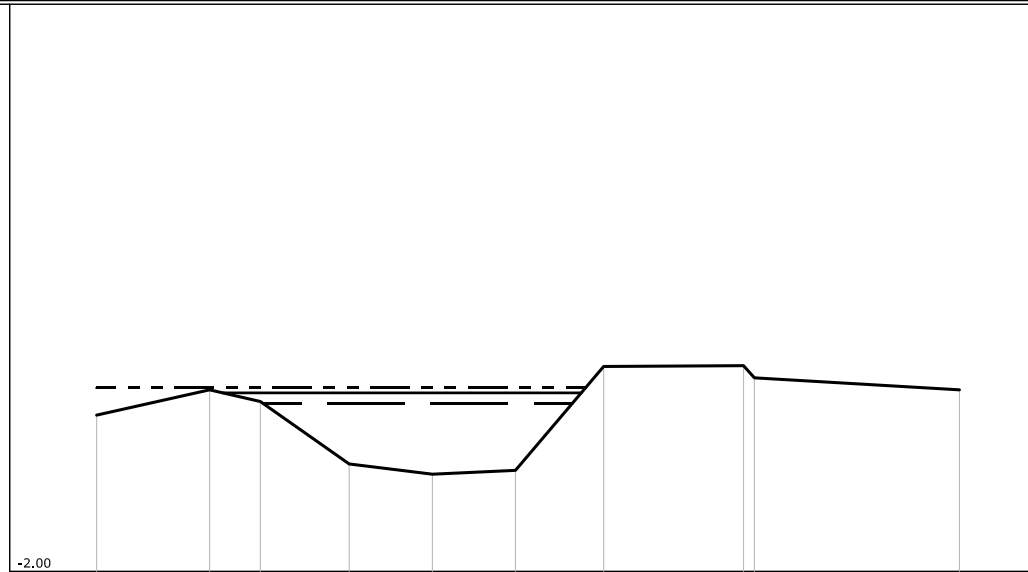

PUNTI	1	2	3	4	5	6	7	8	9	10
QUOTE [m s.l.m.]	2.13	2.80	2.49	0.84	0.57	0.67	3.42	3.44	3.12	2.80
DISTANZE PROGRESSIVE [m]	0.00	2.99	4.33	6.68	8.88	11.08	13.41	17.11	17.40	22.82
DISTANZE PARZIALI [m]		2.99	1.34	2.35	2.20	2.20	2.33	3.70	5.42	



Fosso Maestra  
 SEZIONE N° 00147\_\_06

LEGENDA:

TR30 H = 2.39 m. s.l.m. ———

TR200 H = 2.72 m. s.l.m. ———

TR500 H = 2.85 m. s.l.m. - - - - -

SCALA DISTANZE 1:200  
 SCALA QUOTE 1:200

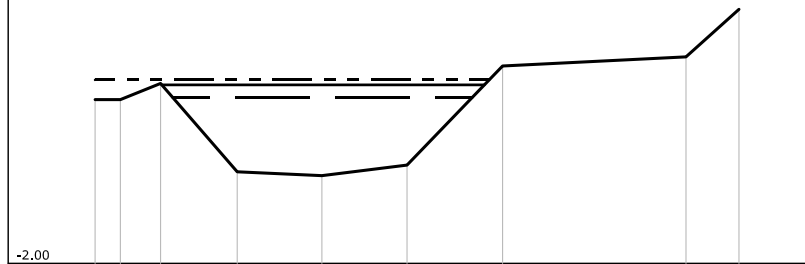

PUNTI	1	2	3	4	5	6	7	8	9
QUOTE [m s.l.m.]	2.33	2.33	2.76	0.42	0.32	0.60	3.22	3.46	4.72
DISTANZE PROGRESSIVE [m]	0.00	0.67	1.73	3.76	6.00	8.25	10.78	15.63	17.03
DISTANZE PARZIALI [m]		1.06	2.03	2.24	2.25	2.53	4.85	1.40	

Fosso Maestra  
 SEZIONE N° 00142\_\_06

LEGENDA:

- TR30 H =2.33 m. s.l.m.
- TR200 H =2.71 m. s.l.m.
- TR500 H =2.84 m. s.l.m.

SCALA DISTANZE 1:200  
 SCALA QUOTE 1:200

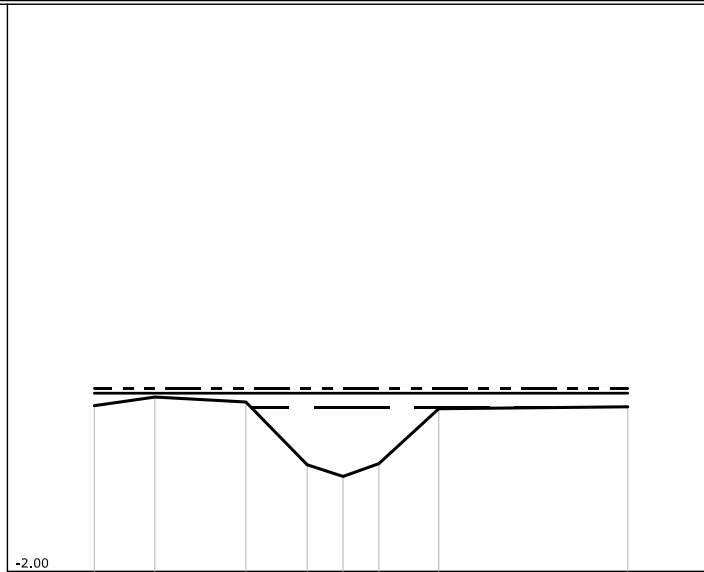

PUNTI	1	2	3	4	5	6	7	8
QUOTE [m s.l.m.]	2.38	2.61	2.48	0.82	0.51	0.85	2.30	2.35
DISTANZE PROGRESSIVE [m]	0.00	1.60	4.01	5.63	6.58	7.53	9.11	14.11
DISTANZE PARZIALI [m]		1.60	2.41	1.62		1.58	5.00	

Fosso Maestra  
 SEZIONE N° 00139\_\_06

**LEGENDA:**

TR30 H =2.31 m. s.l.m. \_\_\_\_\_

TR200 H =2.70 m. s.l.m. \_\_\_\_\_

TR500 H =2.84 m. s.l.m. - - - - -

SCALA DISTANZE 1:200  
 SCALA QUOTE 1:200

-2.00

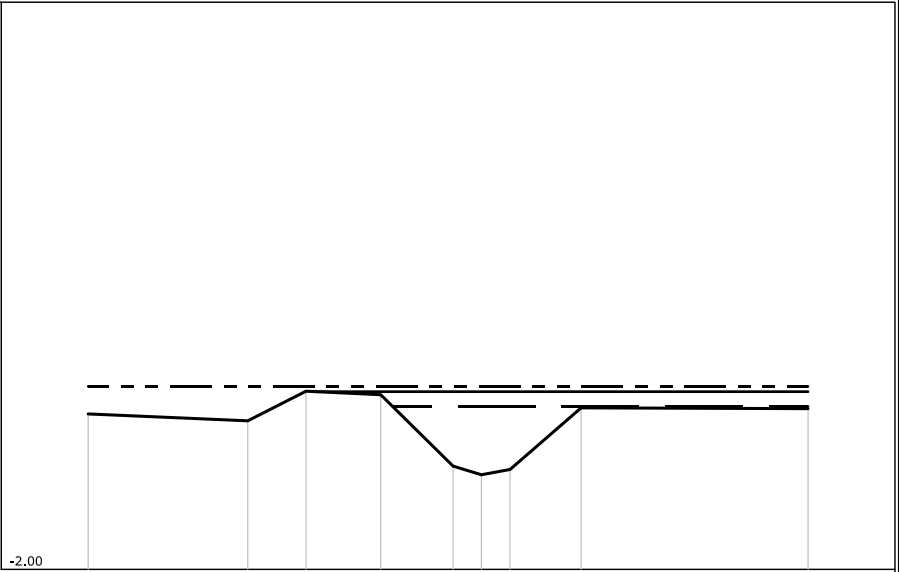

PUNTI	1	2	3	4	5	6	7	8	9
QUOTE [m s.l.m.]	2.11	1.93	2.71	2.62	0.73	0.50	0.64	2.27	2.25
DISTANZE PROGRESSIVE [m]	0.00	4.22	5.76	7.74	9.65	10.40	11.16	13.04	19.04
DISTANZE PARZIALI [m]		4.22	1.54	1.98	1.91		1.88	6.00	

Fosso Maestra  
 SEZIONE N° 00135\_\_06

LEGENDA:

TR30 H =2.32 m. s.l.m. ———

TR200 H =2.71 m. s.l.m. ———

TR500 H =2.84 m. s.l.m. - - - - -

SCALA DISTANZE 1:200  
 SCALA QUOTE 1:200

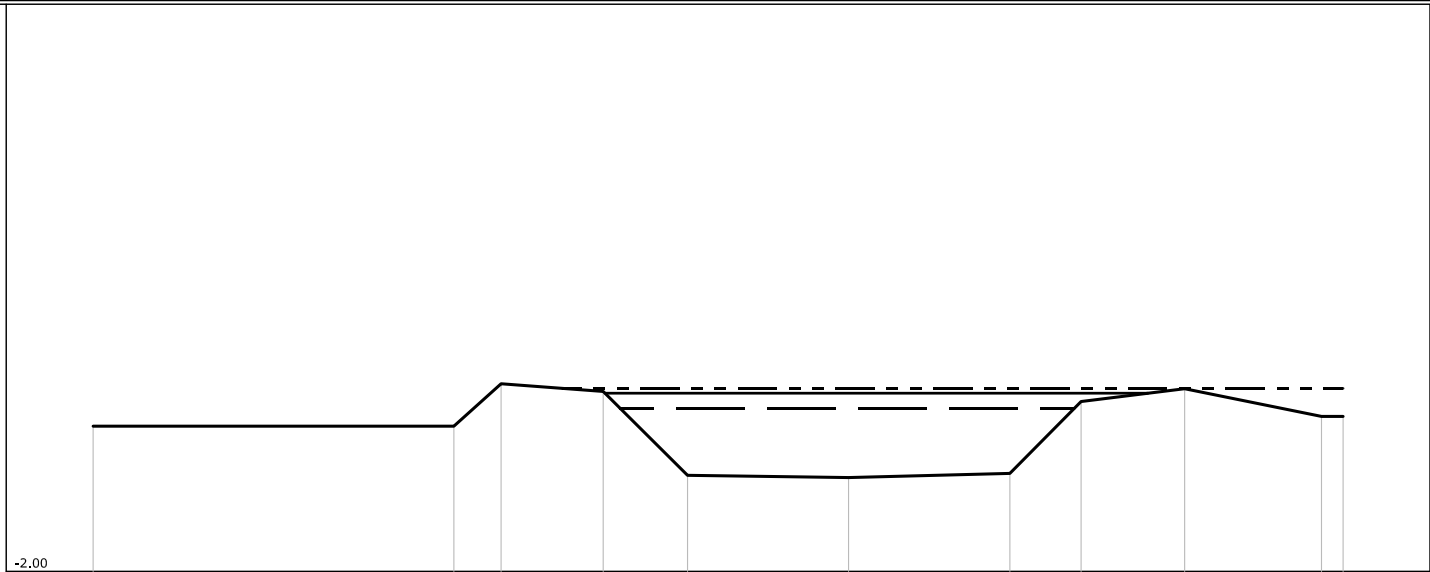

PUNTI	1	2	3	4	5	6	7	8	9	10	11
QUOTE [m s.l.m.]	1.84	1.84	2.96	2.76	0.54	0.48	0.59	2.49	2.83	2.10	2.10
DISTANZE PROGRESSIVE [m]	0.00	9.54	10.79	13.49	15.72	19.98	24.25	26.13	28.87	32.49	33.06
DISTANZE PARZIALI [m]		9.54	1.25	2.70	2.23	4.26	4.27	1.88	2.74	3.62	

Fosso Maestra  
SEZIONE N° 00127\_\_06

LEGENDA:

- TR30 H =2.30 m. s.l.m.
- TR200 H =2.70 m. s.l.m.
- TR500 H =2.84 m. s.l.m.

SCALA DISTANZE 1:200  
SCALA QUOTE 1:200

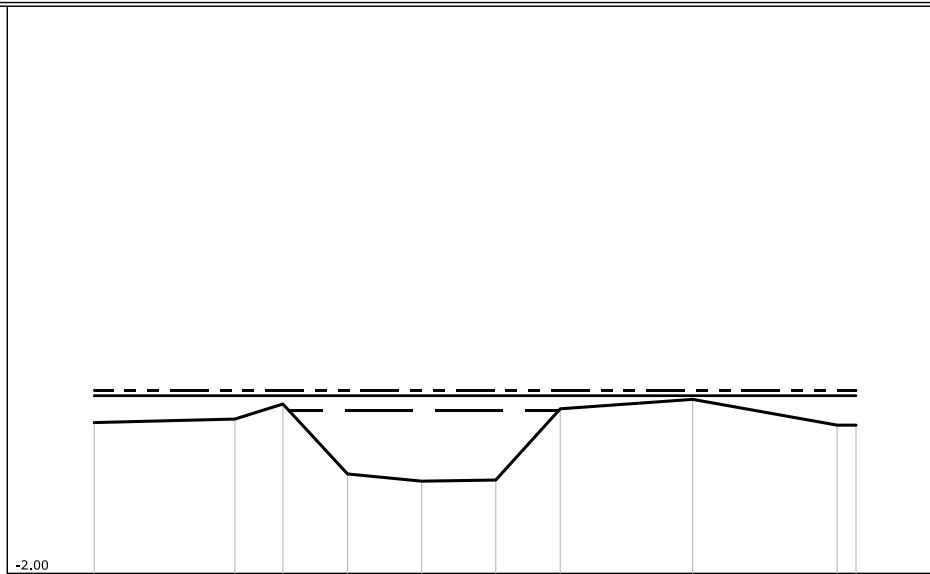

PUNTI	1	2	3	4	5	6	7	8	9	10
QUOTE [m s.l.m.]	1.99	2.08	2.48	0.63	0.44	0.47	2.35	2.60	1.92	1.92
DISTANZE PROGRESSIVE [m]	0.00	3.72	4.99	6.70	8.66	10.62	12.33	15.83	19.65	20.15
DISTANZE PARZIALI [m]		3.72	1.27	1.71	1.96	1.96	1.71	3.50	3.82	

Fosso Maestra  
 SEZIONE N° 00119\_\_06

LEGENDA:

- TR30 H = 2.27 m. s.l.m.
- TR200 H = 2.69 m. s.l.m.
- TR500 H = 2.83 m. s.l.m.

SCALA DISTANZE 1:200  
 SCALA QUOTE 1:200

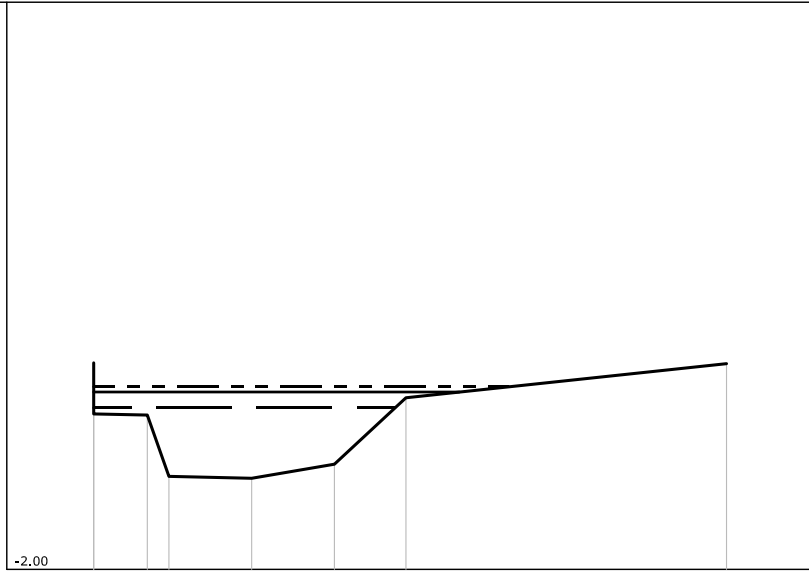



PUNTI	1	3	4	5	6	7	8
QUOTE [m s.l.m.]	3.46	2.08	0.46	0.41	0.78	2.54	3.44
DISTANZE PROGRESSIVE [m]	0.00	1.42	1.99	4.18	6.37	8.26	16.74
DISTANZE PARZIALI [m]		1.42	2.19	2.19	1.89	8.48	

Fosso Maestra  
 SEZIONE N° 00111\_\_06

LEGENDA:

TR30 H = 2.20 m. s.l.m. 

TR200 H = 2.69 m. s.l.m. 

TR500 H = 2.83 m. s.l.m. 

SCALA DISTANZE 1:200  
 SCALA QUOTE 1:200

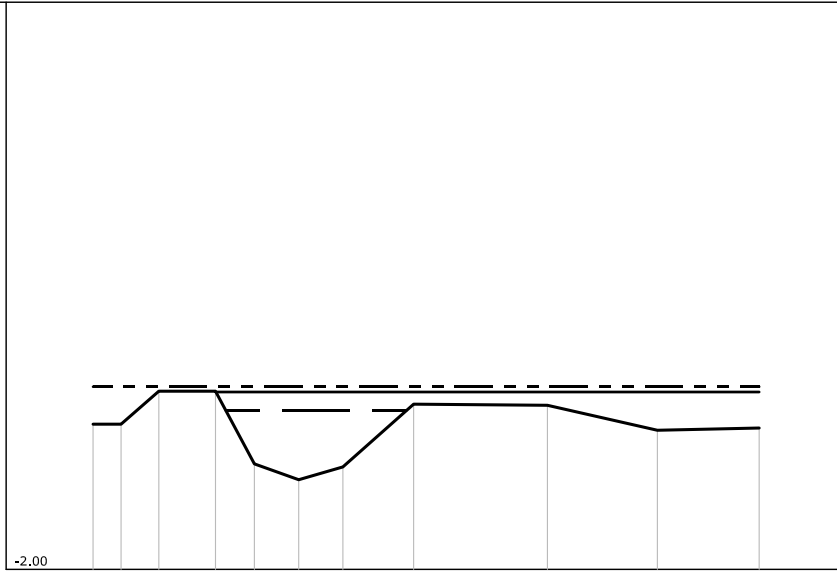

PUNTI	1	2	3	4	5	6	7	8	9	10	11
QUOTE [m s.l.m.]	1.84	1.84	2.71	2.71	0.79	0.37	0.71	2.37	2.34	1.68	1.74
DISTANZE PROGRESSIVE [m]	0.00	0.74	1.74	3.24	4.27	5.44	6.61	8.48	12.02	14.93	17.62
DISTANZE PARZIALI [m]		1.00	1.50	1.03	1.17	1.17	1.87	3.54	2.91	2.69	

Fosso Maestra  
 SEZIONE N° 00109PA06

LEGENDA:

- TR30 H = 2.20 m. s.l.m.
- TR200 H = 2.69 m. s.l.m.
- TR500 H = 2.83 m. s.l.m.

SCALA DISTANZE 1:200  
 SCALA QUOTE 1:200

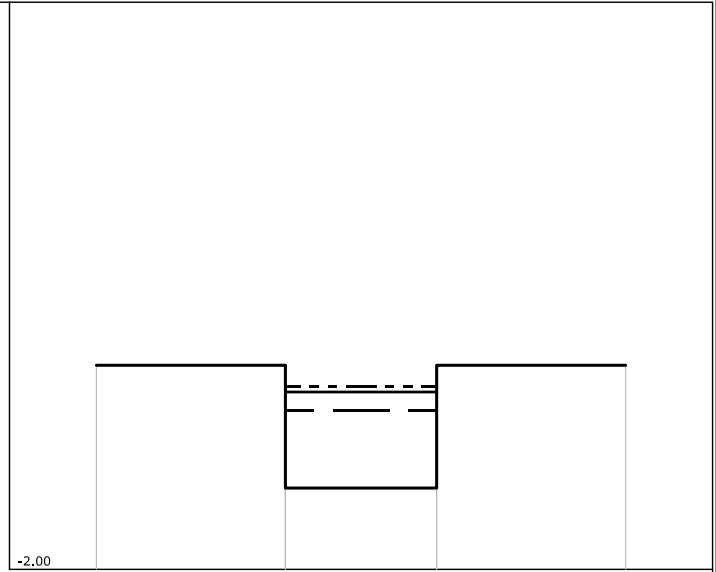



PUNTI	1	2	5	7
QUOTE [m s.l.m.]	3.40	3.40	0.15	3.40
DISTANZE PROGRESSIVE [m]	0.00	5.00	9.00	14.00
DISTANZE PARZIALI [m]		5.00	4.00	5.00



Fosso Maestra  
 SEZIONE N° 00109PB06

LEGENDA:

TR30 H = 2.20 m. s.l.m. 

TR200 H = 2.69 m. s.l.m. 

TR500 H = 2.83 m. s.l.m. 

SCALA DISTANZE 1:200  
 SCALA QUOTE 1:200

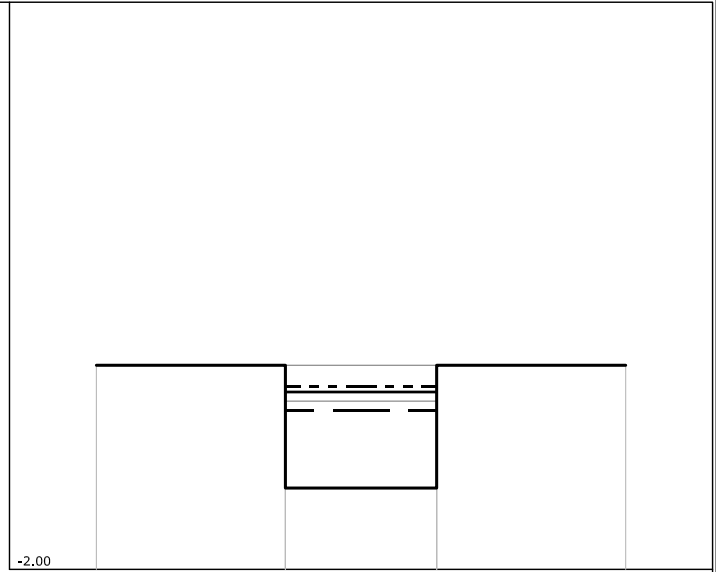

PUNTI	1	2	5	8
QUOTE [m s.l.m.]	3.40	3.40	0.15	3.40
DISTANZE PROGRESSIVE [m]	0.00	5.00	9.00	14.00
DISTANZE PARZIALI [m]		5.00	4.00	5.00

Fosso Maestra  
 SEZIONE N° 00109PC06

LEGENDA:

- TR30 H =2.17 m. s.l.m.
- TR200 H =2.68 m. s.l.m.
- TR500 H =2.81 m. s.l.m.

SCALA DISTANZE 1:200  
 SCALA QUOTE 1:200

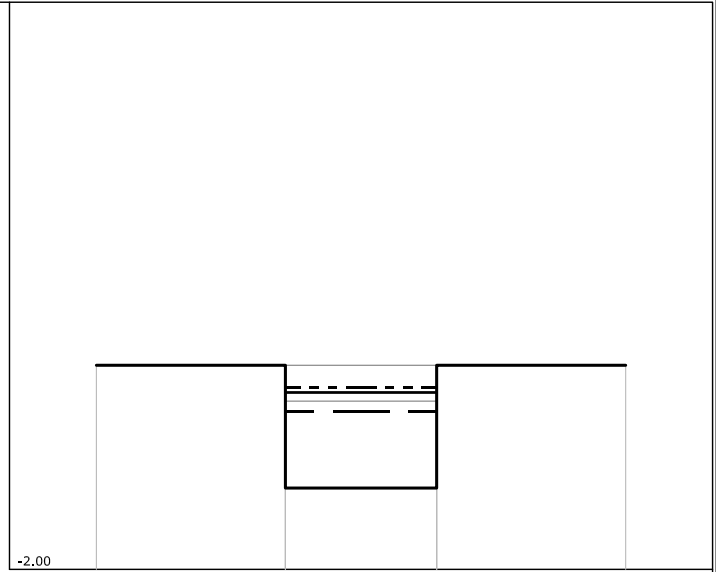



PUNTI	1	2	5	8
QUOTE [m s.l.m.]	3.40	3.40	0.15	3.40
DISTANZE PROGRESSIVE [m]	0.00	5.00	9.00	14.00
DISTANZE PARZIALI [m]		5.00	4.00	5.00

Fosso Maestra  
 SEZIONE N° 00109PD06

LEGENDA:

TR30 H =2.16 m. s.l.m. 

TR200 H =2.68 m. s.l.m. 

TR500 H =2.81 m. s.l.m. 

SCALA DISTANZE 1:200  
 SCALA QUOTE 1:200

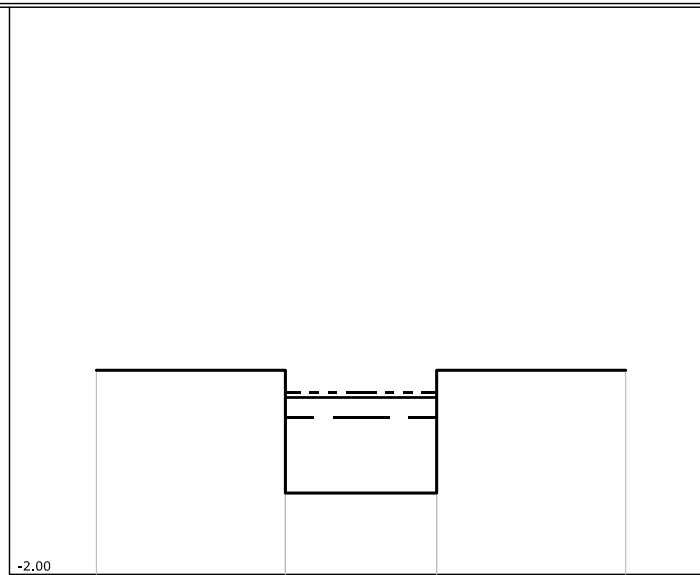



PUNTI	1	2	5	7
QUOTE [m s.l.m.]	3.40	3.40	0.15	3.40
DISTANZE PROGRESSIVE [m]	0.00	5.00	9.00	14.00
DISTANZE PARZIALI [m]		5.00	4.00	5.00

Fosso Maestra  
 SEZIONE N° 00107\_\_06

LEGENDA:

TR30 H = 2.16 m. s.l.m. 

TR200 H = 2.68 m. s.l.m. 

TR500 H = 2.81 m. s.l.m. 

SCALA DISTANZE 1:200  
 SCALA QUOTE 1:200

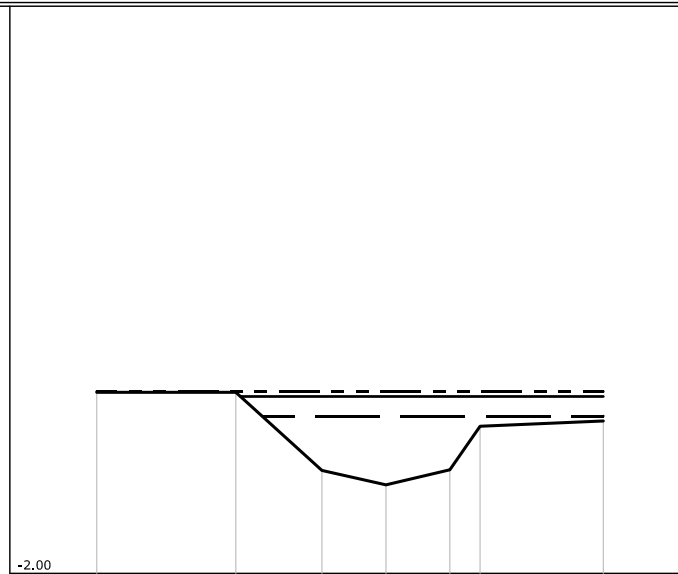

PUNTI	1	2	3	4	5	6	7
QUOTE [m s.l.m.]	2.79	2.79	0.72	0.34	0.74	1.89	2.03
DISTANZE PROGRESSIVE [m]	0.00	3.68	5.96	7.65	9.34	10.14	13.40
DISTANZE PARZIALI [m]		3.68	2.28	1.69	1.69		3.26

Fosso Maestra  
 SEZIONE N° 00097\_\_06

LEGENDA:

TR30 H =2.15 m. s.l.m. ———

TR200 H =2.68 m. s.l.m. ————

TR500 H =2.82 m. s.l.m. - - - - -

SCALA DISTANZE 1:200  
 SCALA QUOTE 1:200

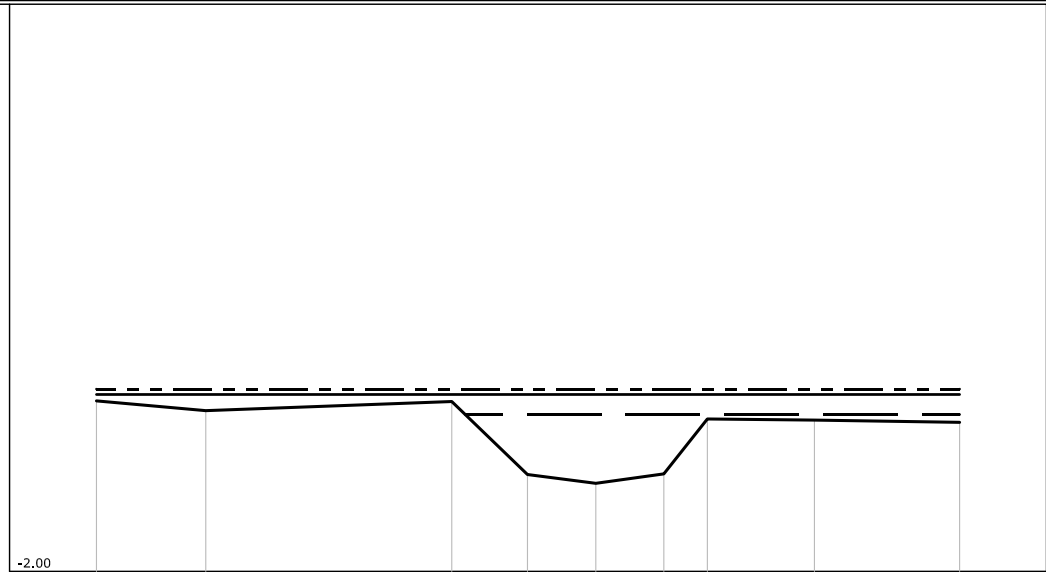

PUNTI	1	2	3	4	5	6	7	8	9
QUOTE [m s.l.m.]	2.51	2.25	2.49	0.56	0.33	0.58	2.03	2.00	1.94
DISTANZE PROGRESSIVE [m]	0.00	2.89	9.40	11.40	13.21	15.01	16.16	18.99	22.83
DISTANZE PARZIALI [m]		2.89	6.51	2.00	1.81	1.80	1.15	2.83	3.84

Fosso Maestra  
 SEZIONE N° 00089\_\_06

LEGENDA:

TR30 H =2.16 m. s.l.m. 

TR200 H =2.67 m. s.l.m. 

TR500 H =2.81 m. s.l.m. 

SCALA DISTANZE 1:200  
 SCALA QUOTE 1:200

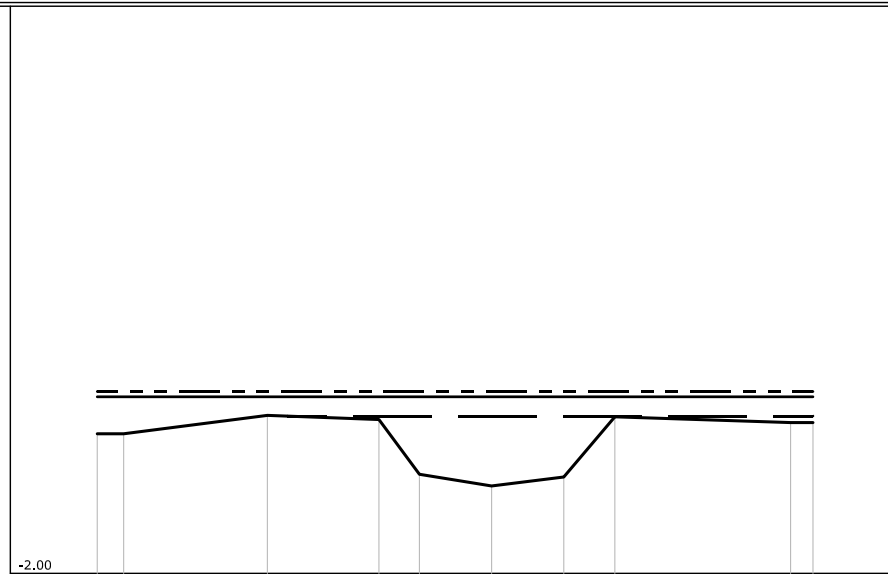

PUNTI	1	2	3	4	5	6	7	8	9	10
QUOTE [m s.l.m.]	1.69	1.69	2.18	2.07	0.62	0.31	0.55	2.14	1.99	1.99
DISTANZE PROGRESSIVE [m]	0.00	0.70	4.50	7.45	8.52	10.43	12.34	13.69	18.34	18.93
DISTANZE PARZIALI [m]			3.80	2.95	1.07	1.91	1.91	1.35	4.65	

Fosso Maestra  
SEZIONE N° 00080\_\_06

LEGENDA:

TR30 H =2.15 m. s.l.m. \_\_\_\_\_

TR200 H =2.68 m. s.l.m. \_\_\_\_\_

TR500 H =2.82 m. s.l.m. \_\_\_\_\_

SCALA DISTANZE 1:200  
SCALA QUOTE 1:200

-2.00

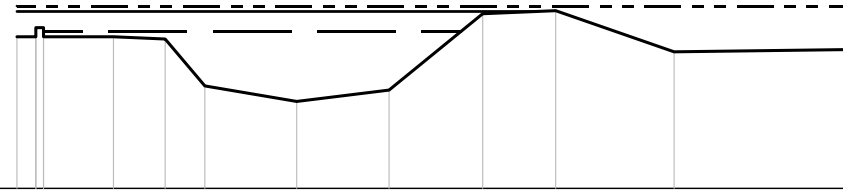

PUNTI	1	2	6	7	8	9	10	11	12	13	14
QUOTE [m s.l.m.]	2.01	2.01	2.01	1.95	0.71	0.30	0.60	2.62	2.70	1.61	1.67
DISTANZE PROGRESSIVE [m]	0.00	0.50	2.55	3.92	4.97	7.40	9.84	12.32	14.25	17.38	21.96
DISTANZE PARZIALI [m]		1.85	1.37	1.05	2.43	2.44	2.48	1.93	3.13	4.58	

Fosso Maestra  
 SEZIONE N° 00075\_\_06

LEGENDA:

TR30 H =2.12 m. s.l.m. \_\_\_\_\_

TR200 H =2.67 m. s.l.m. \_\_\_\_\_

TR500 H =2.81 m. s.l.m. - - - - -

SCALA DISTANZE 1:200  
 SCALA QUOTE 1:200

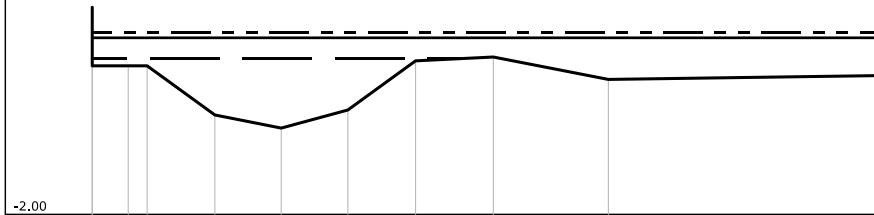

PUNTI	1	3	4	5	6	7	8	9	10	11
QUOTE [m s.l.m.]	3.48	1.93	1.93	0.63	0.28	0.76	2.06	2.16	1.57	1.67
DISTANZE PROGRESSIVE [m]	0.00	0.95	1.45	3.24	5.00	6.76	8.55	10.61	13.65	20.83
DISTANZE PARZIALI [m]			1.79	1.76	1.76	1.79	2.06	3.04	7.18	



Fosso Maestra  
 SEZIONE N° 00069\_\_06

LEGENDA:

- TR30 H =2.09 m. s.l.m.
- TR200 H =2.66 m. s.l.m.
- TR500 H =2.80 m. s.l.m.

SCALA DISTANZE 1:200  
 SCALA QUOTE 1:200

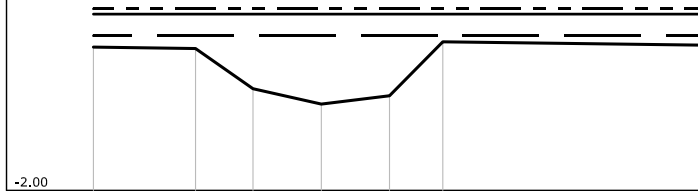

PUNTI	1	2	3	4	5	6	7
QUOTE [m s.l.m.]	1.79	1.75	0.69	0.28	0.50	1.93	1.84
DISTANZE PROGRESSIVE [m]	0.00	2.70	4.22	6.03	7.83	9.24	16.17
DISTANZE PARZIALI [m]		2.70	1.52	1.81	1.80	1.41	6.93

Fosso Maestra  
SEZIONE N° 00059\_\_06

LEGENDA:

TR30 H =2.08 m. s.l.m. ———

TR200 H =2.66 m. s.l.m. ———

TR500 H =2.80 m. s.l.m. - - - - -

SCALA DISTANZE 1:200  
SCALA QUOTE 1:200

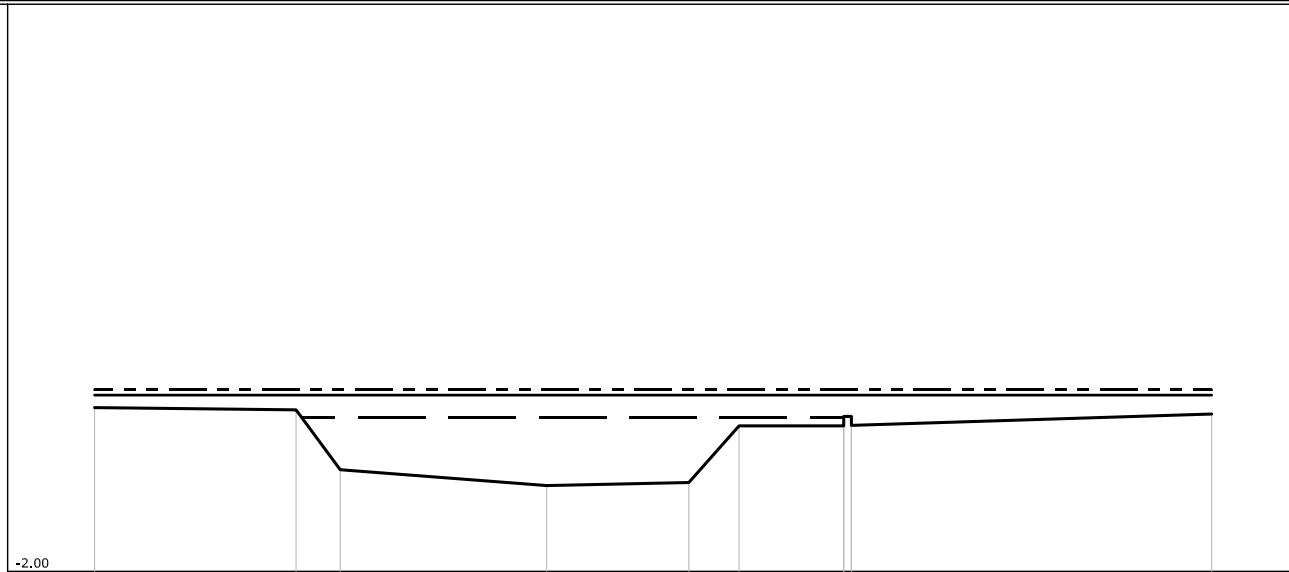



PUNTI	1	2	3	4	5	6	7	11
QUOTE [m s.l.m.]	2.33	2.27	0.69	0.27	0.35	1.85	1.85	2.16
DISTANZE PROGRESSIVE [m]	0.00	5.33	6.50	11.96	15.72	17.05	19.82	29.55
DISTANZE PARZIALI [m]		5.33	1.17	5.46	3.76	1.33	2.77	9.53

Fosso Maestra  
 SEZIONE N° 00058PA06

LEGENDA:

TR30 H = 2.08 m. s.l.m. 

TR200 H = 2.66 m. s.l.m. 

TR500 H = 2.79 m. s.l.m. 

SCALA DISTANZE 1:200  
 SCALA QUOTE 1:200

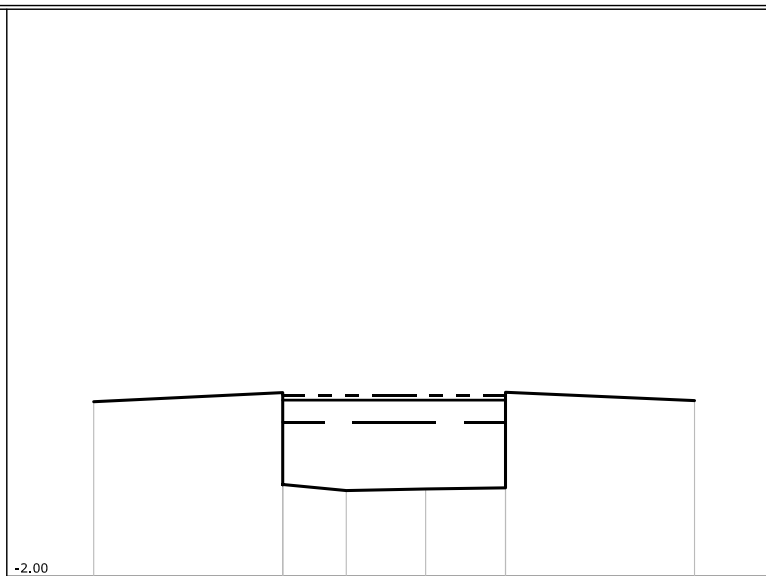

PUNTI	1	2	5	6	7	9
QUOTE [m s.l.m.]	2.62	2.86	0.27	0.31	0.34	2.65
DISTANZE PROGRESSIVE [m]	0.00	5.00	6.68	8.78	10.89	15.89
DISTANZE PARZIALI [m]		5.00	1.68	2.10	2.11	5.00

Fosso Maestra  
 SEZIONE N° 00058PB06

LEGENDA:

- TR30 H = 2.08 m. s.l.m.
- TR200 H = 2.66 m. s.l.m.
- TR500 H = 2.79 m. s.l.m.

SCALA DISTANZE 1:200  
 SCALA QUOTE 1:200

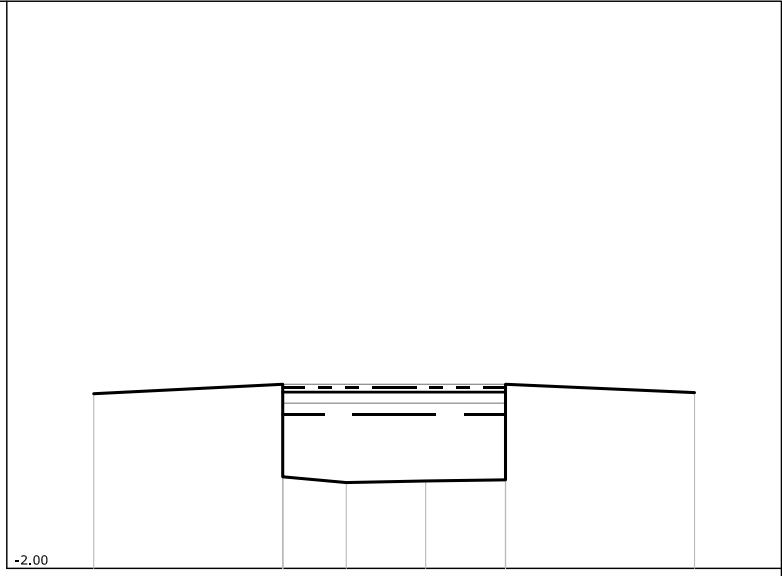



PUNTI	1	2	6	7	8	11
QUOTE [m s.l.m.]	2.62	2.87	0.27	0.31	0.34	2.65
DISTANZE PROGRESSIVE [m]	0.00	5.00	6.68	8.78	10.89	15.89
DISTANZE PARZIALI [m]		5.00	1.68	2.10	2.11	5.00

Fosso Maestra  
 SEZIONE N° 00058PC06

LEGENDA:

TR30 H = 2.05 m. s.l.m. 

TR200 H = 2.64 m. s.l.m. 

TR500 H = 2.76 m. s.l.m. 

SCALA DISTANZE 1:200  
 SCALA QUOTE 1:200

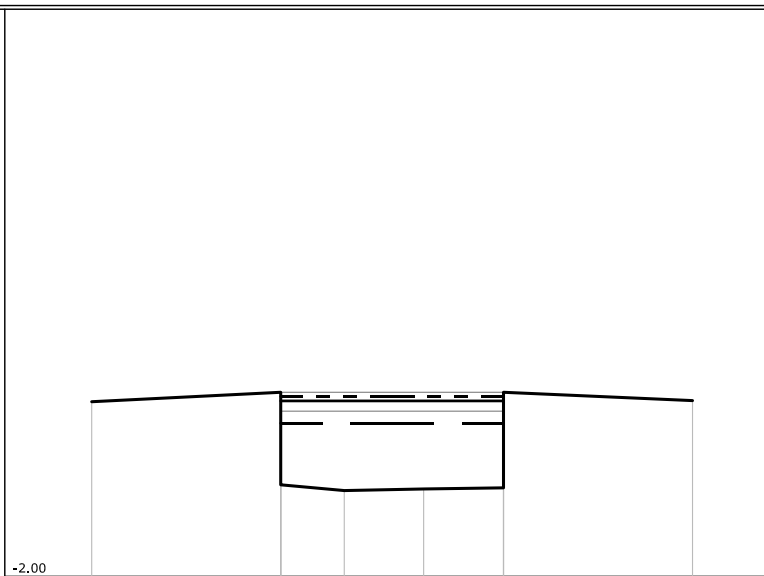

PUNTI	1	2	6	7	8	11
QUOTE [m s.l.m.]	2.62	2.87	0.27	0.31	0.34	2.65
DISTANZE PROGRESSIVE [m]	0.00	5.00	6.68	8.78	10.89	15.89
DISTANZE PARZIALI [m]		5.00	1.68	2.10	2.11	5.00

Fosso Maestra  
 SEZIONE N° 00058PD06

LEGENDA:

- TR30 H = 2.05 m. s.l.m.
- TR200 H = 2.64 m. s.l.m.
- TR500 H = 2.76 m. s.l.m.

SCALA DISTANZE 1:200  
 SCALA QUOTE 1:200

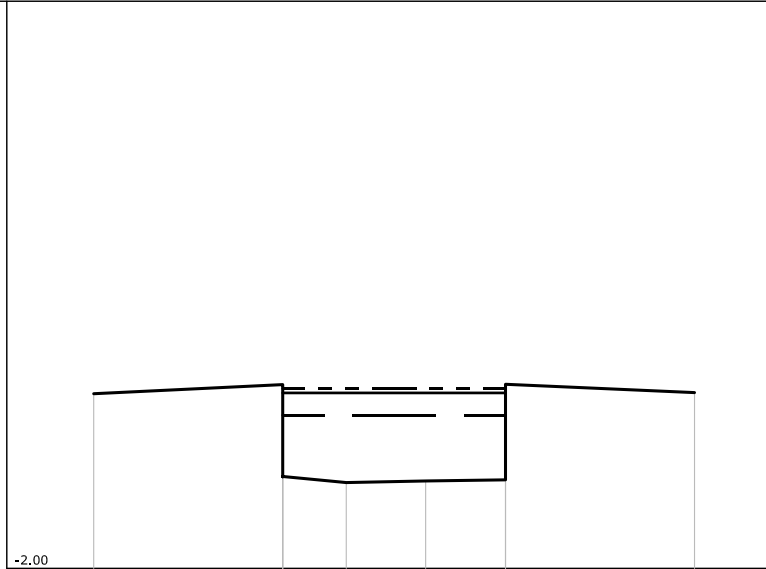

PUNTI	1	2	5	6	7	9
QUOTE [m s.l.m.]	2.62	2.86	0.27	0.31	0.34	2.65
DISTANZE PROGRESSIVE [m]	0.00	5.00	6.68	8.78	10.89	15.89
DISTANZE PARZIALI [m]		5.00	1.68	2.10	2.11	5.00

Fosso Maestra  
 SEZIONE N° 00057\_\_06

LEGENDA:

TR30 H = 2.05 m. s.l.m. 

TR200 H = 2.64 m. s.l.m. 

TR500 H = 2.76 m. s.l.m. 

SCALA DISTANZE 1:200  
 SCALA QUOTE 1:200

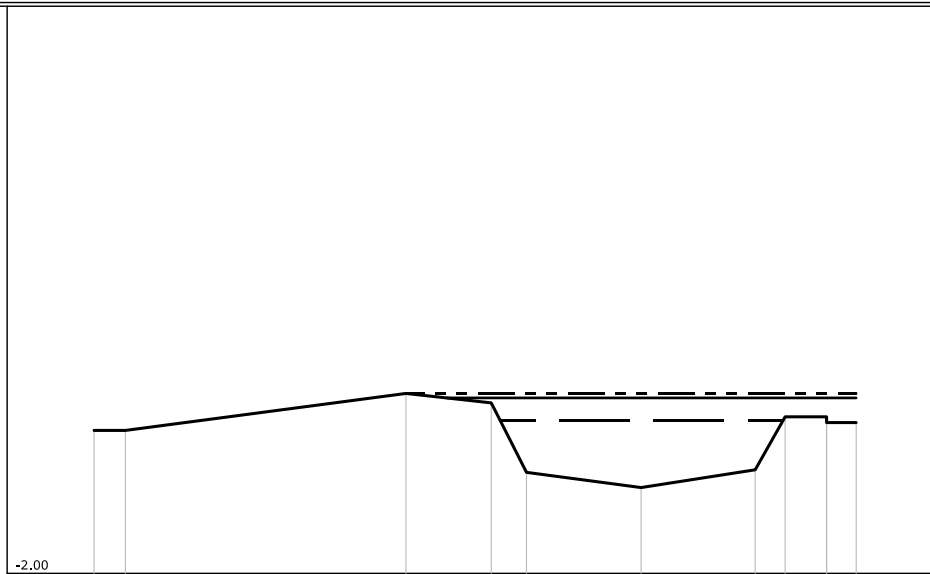



PUNTI	1	2	3	4	5	6	7	8	9	11
QUOTE [m s.l.m.]	1.78	1.78	2.76	2.51	0.67	0.27	0.74	2.14	2.14	1.99
DISTANZE PROGRESSIVE [m]	0.00	0.83	8.25	10.51	11.44	14.47	17.49	18.28	19.38	20.16
DISTANZE PARZIALI [m]			7.42	2.26		3.03	3.02		1.10	

Fosso Maestra  
 SEZIONE N° 00052\_\_06

LEGENDA:

TR30 H =2.04 m. s.l.m. 

TR200 H =2.64 m. s.l.m. 

TR500 H =2.76 m. s.l.m. 

SCALA DISTANZE 1:200  
 SCALA QUOTE 1:200

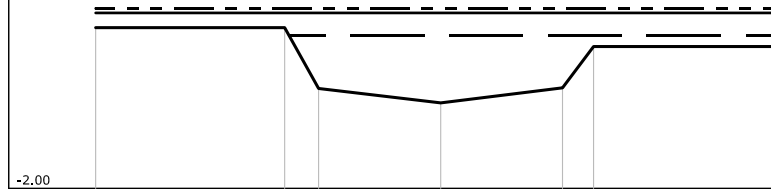



PUNTI	1	2	3	4	5	6	7
QUOTE [m s.l.m.]	2.25	2.25	0.64	0.26	0.66	1.75	1.75
DISTANZE PROGRESSIVE [m]	0.00	5.00	5.90	9.13	12.35	13.17	18.17
DISTANZE PARZIALI [m]		5.00		3.23	3.22		5.00



Fosso Maestra  
 SEZIONE N° 00047\_\_06

LEGENDA:

TR30 H =2.04 m. s.l.m. 

TR200 H =2.64 m. s.l.m. 

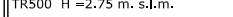
TR500 H =2.75 m. s.l.m. 

SCALA DISTANZE 1:200  
 SCALA QUOTE 1:200

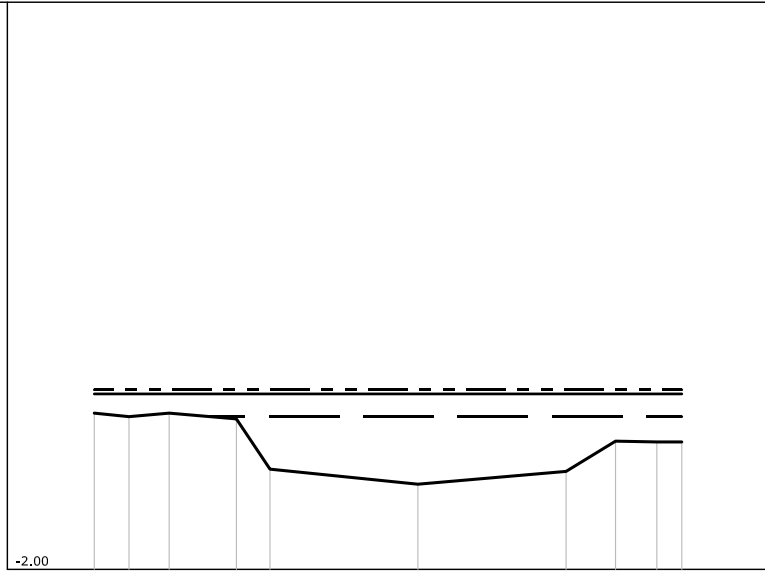

PUNTI	1	2	3	4	5	6	7	8	9	10
QUOTE [m s.l.m.]	2.13	2.04	2.13	1.98	0.65	0.25	0.59	1.39	1.37	1.37
DISTANZE PROGRESSIVE [m]	0.00	0.92	1.98	3.76	4.65	8.56	12.48	13.79	14.88	15.54
DISTANZE PARZIALI [m]		1.06	1.78			3.91	3.92	1.31	1.09	

Fosso Maestra  
 SEZIONE N° 00042\_\_06

LEGENDA:

TR30 H =2.03 m. s.l.m. 

TR200 H =2.63 m. s.l.m. 

TR500 H =2.74 m. s.l.m. 

SCALA DISTANZE 1:200  
 SCALA QUOTE 1:200

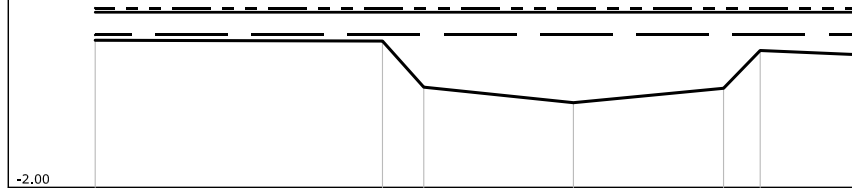

PUNTI	1	2	3	4	5	6	7
QUOTE [m s.l.m.]	1.89	1.87	0.65	0.24	0.62	1.62	1.50
DISTANZE PROGRESSIVE [m]	0.00	7.60	8.69	12.65	16.62	17.59	20.36
DISTANZE PARZIALI [m]		7.60	1.09	3.96	3.97	0.97	2.77

Fosso Maestra  
 SEZIONE N° 00038\_\_06

LEGENDA:

- TR30 H =2.03 m. s.l.m.
- TR200 H =2.62 m. s.l.m.
- TR500 H =2.72 m. s.l.m.

SCALA DISTANZE 1:200  
 SCALA QUOTE 1:200

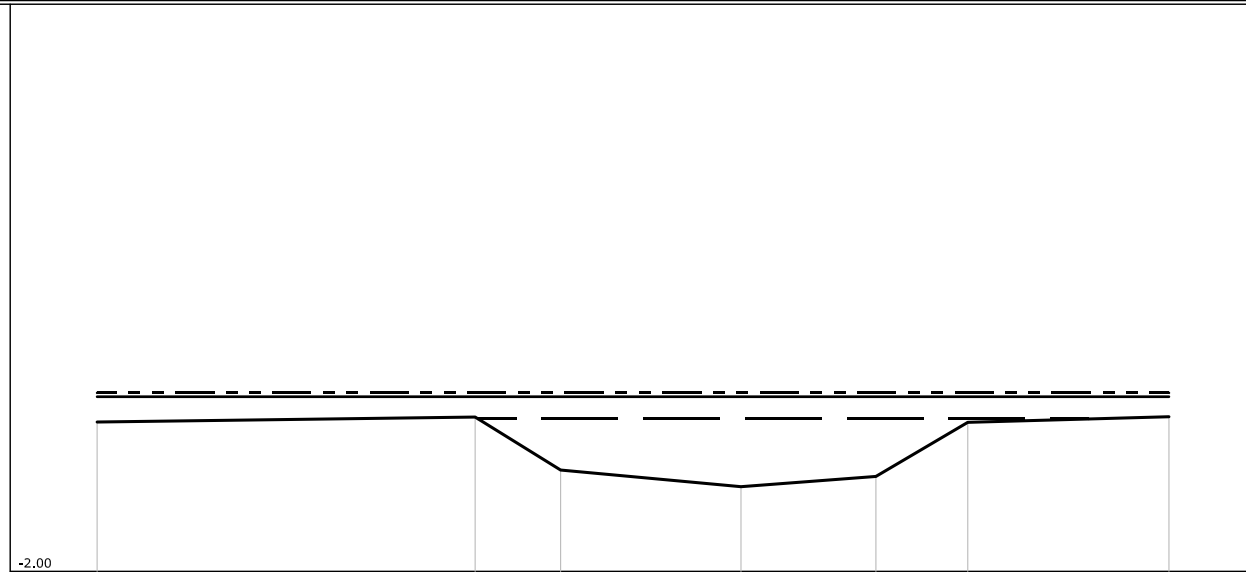



PUNTI	1	2	3	4	5	6	7
QUOTE [m s.l.m.]	1.95	2.08	0.68	0.24	0.51	1.94	2.09
DISTANZE PROGRESSIVE [m]	0.00	10.00	12.26	17.03	20.60	23.03	28.35
DISTANZE PARZIALI [m]		10.00	2.26	4.77	3.57	2.43	5.32

Fosso Maestra  
 SEZIONE N° 00036PA06

**LEGENDA:**

TR30 H = 2.03 m. s.l.m. 

TR200 H = 2.61 m. s.l.m. 

TR500 H = 2.70 m. s.l.m. 

SCALA DISTANZE 1:200  
 SCALA QUOTE 1:200

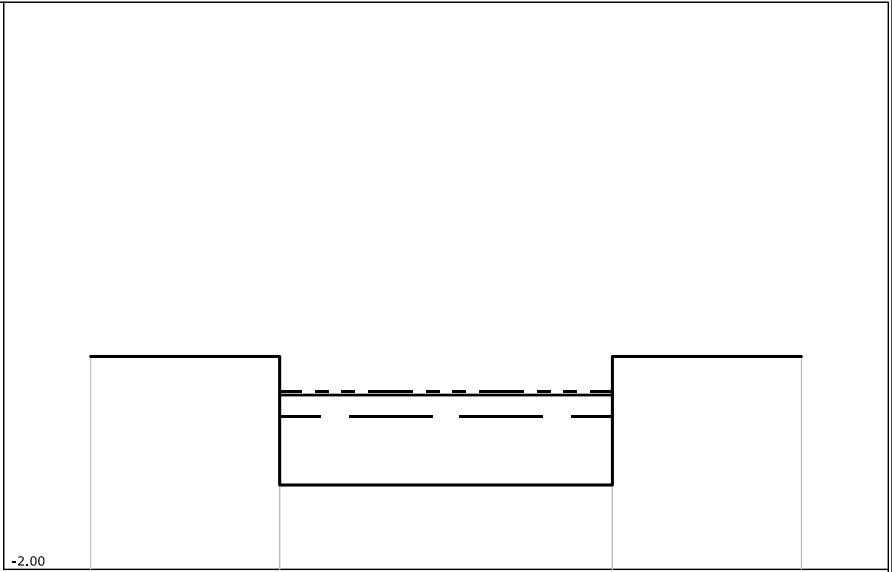

PUNTI	1	2	4	6
QUOTE [m s.l.m.]	3.63	3.63	0.23	3.63
DISTANZE PROGRESSIVE [m]	0.00	5.00	13.80	18.80
DISTANZE PARZIALI [m]		5.00	8.80	5.00

Fosso Maestra  
 SEZIONE N° 00036PB06

LEGENDA:

TR30 H = 2.03 m. s.l.m. 

TR200 H = 2.61 m. s.l.m. 

TR500 H = 2.70 m. s.l.m. 

SCALA DISTANZE 1:200  
 SCALA QUOTE 1:200

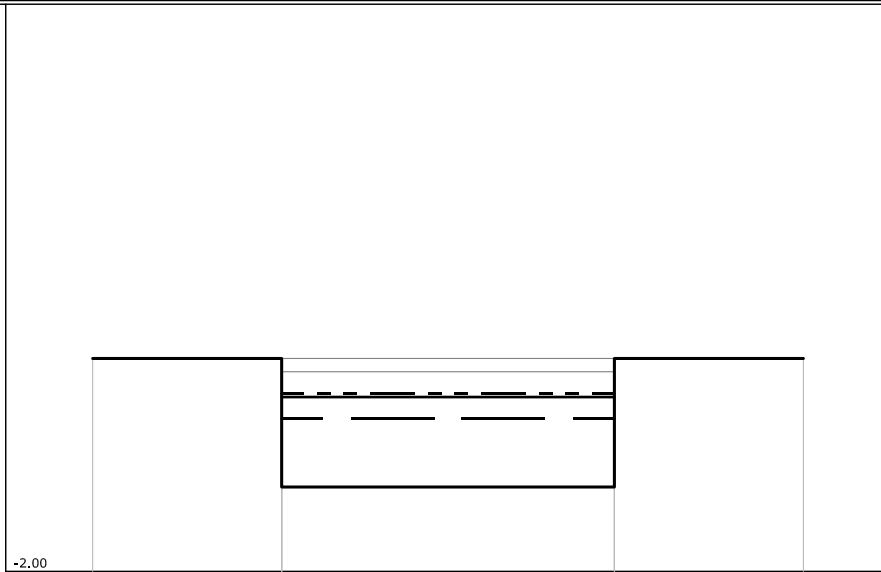

PUNTI	1	2	6	9
QUOTE [m s.l.m.]	3.63	3.63	0.23	3.63
DISTANZE PROGRESSIVE [m]	0.00	5.00	13.80	18.80
DISTANZE PARZIALI [m]		5.00	8.80	5.00

Fosso Maestra  
 SEZIONE N° 00036PC06

LEGENDA:

TR30 H = 2.00 m. s.l.m. 

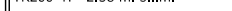
TR200 H = 2.58 m. s.l.m. 

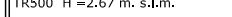
TR500 H = 2.67 m. s.l.m. 

SCALA DISTANZE 1:200  
 SCALA QUOTE 1:200

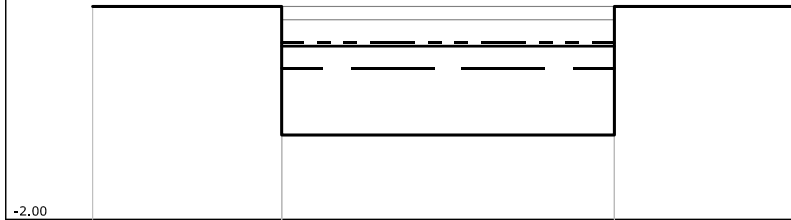

PUNTI	1	2	6	9
QUOTE [m s.l.m.]	3.63	3.63	0.23	3.63
DISTANZE PROGRESSIVE [m]	0.00	5.00	13.80	18.80
DISTANZE PARZIALI [m]		5.00	8.80	5.00

Fosso Maestra  
 SEZIONE N° 00036PD06

**LEGENDA:**

TR30 H =2.00 m. s.l.m. \_\_\_\_\_

TR200 H =2.58 m. s.l.m. \_\_\_\_\_

TR500 H =2.67 m. s.l.m. - - - - -

SCALA DISTANZE 1:200  
 SCALA QUOTE 1:200

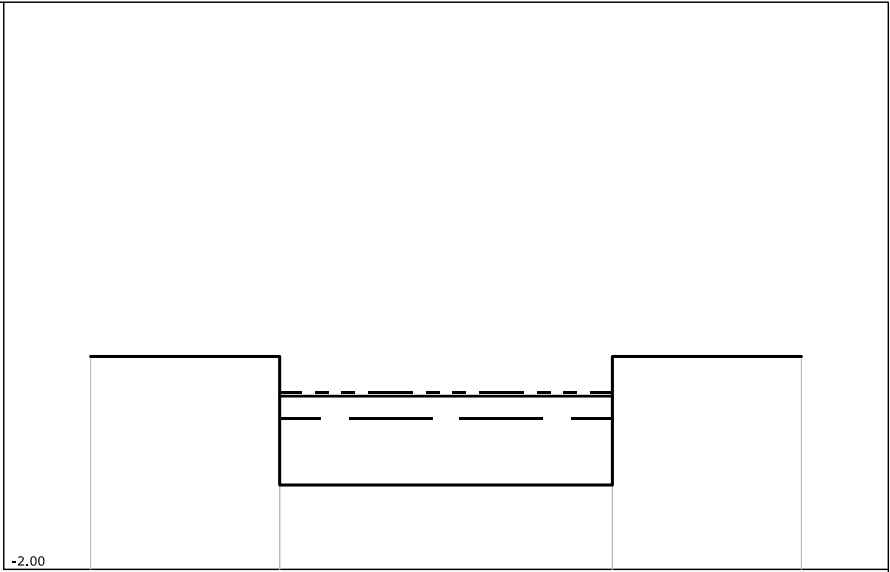

PUNTI	1	2	4	6
QUOTE [m s.l.m.]	3.63	3.63	0.23	3.63
DISTANZE PROGRESSIVE [m]	0.00	5.00	13.80	18.80
DISTANZE PARZIALI [m]		5.00	8.80	5.00

Fosso Maestra  
 SEZIONE N° 00034\_\_06

LEGENDA:

- TR30 H = 1.99 m. s.l.m.
- TR200 H = 2.55 m. s.l.m.
- TR500 H = 2.62 m. s.l.m.

SCALA DISTANZE 1:200  
 SCALA QUOTE 1:200

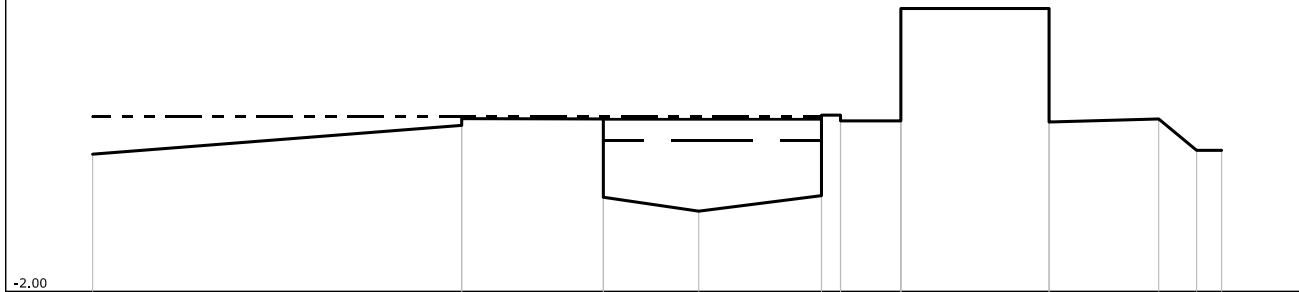

PUNTI	1	2	4	6	7	9	11	14	16	17	18
QUOTE [m s.l.m.]	1.63	2.39	2.56	0.12	0.53	2.66	2.51	5.48	2.56	1.73	1.73
DISTANZE PROGRESSIVE [m]	0.00	9.76	13.51	16.03	19.28	19.78	21.38	25.30	28.20	29.20	29.86
DISTANZE PARZIALI [m]		9.76	3.75	2.52	3.25	1.60	3.92	2.90	1.00		



Fosso Maestra  
SEZIONE N° 00025\_\_06

LEGENDA:

TR30 H = 1.99 m. s.l.m. 

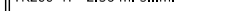
TR200 H = 2.56 m. s.l.m. 

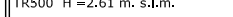
TR500 H = 2.61 m. s.l.m. 

SCALA DISTANZE 1:200  
SCALA QUOTE 1:200

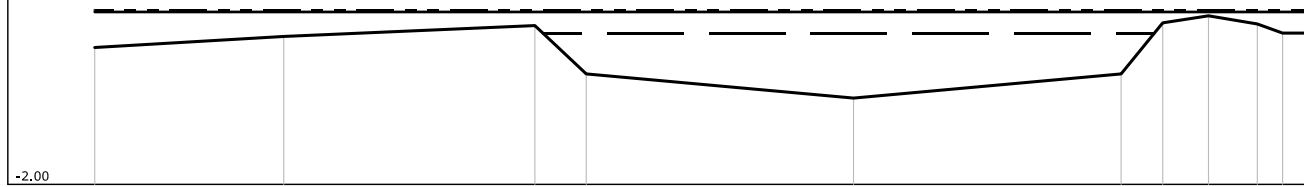

PUNTI	1	2	3	4	5	6	7	8	9	10	11
QUOTE [m s.l.m.]	1.62	1.91	2.20	0.92	0.28	0.92	2.27	2.46	2.24	2.00	2.00
DISTANZE PROGRESSIVE [m]	0.00	5.00	11.64	13.00	20.07	27.15	28.25	29.46	30.75	31.42	32.13
DISTANZE PARZIALI [m]		5.00	6.64	1.36	7.07	7.08	1.10	1.21	1.29		

Fosso Maestra  
 SEZIONE N° 00021\_\_06

LEGENDA:

- TR30 H = 1.99 m. s.l.m.
- TR200 H = 2.56 m. s.l.m.
- TR500 H = 2.62 m. s.l.m.

SCALA DISTANZE 1:200  
 SCALA QUOTE 1:200

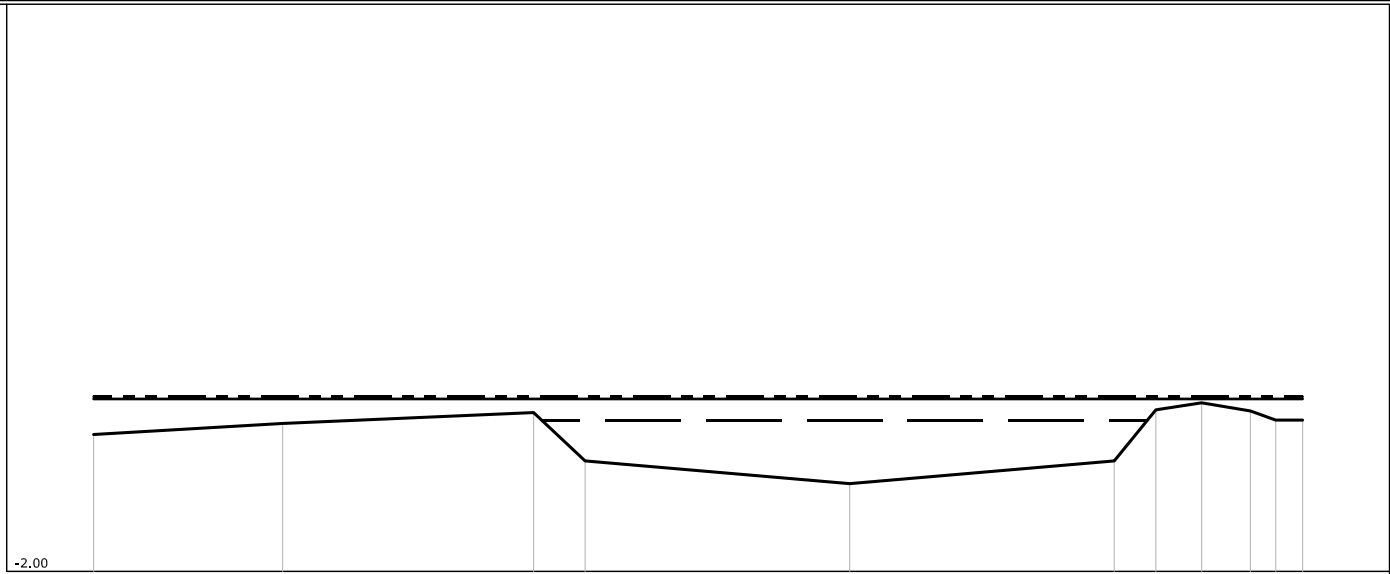

PUNTI	1	2	3	4	5	6	7	8	9	10	11
QUOTE [m s.l.m.]	1.62	1.91	2.20	0.92	0.32	0.92	2.27	2.46	2.24	2.00	2.00
DISTANZE PROGRESSIVE [m]	0.00	5.00	11.64	13.00	20.00	27.00	28.10	29.31	30.60	31.27	31.98
DISTANZE PARZIALI [m]		5.00	6.64	1.36	7.00	7.00	1.10	1.21	1.29		

Fosso Maestra  
SEZIONE N° 00017\_\_06

LEGENDA:

TR30 H =1.97 m. s.l.m. 

TR200 H =2.55 m. s.l.m. 

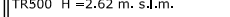
TR500 H =2.62 m. s.l.m. 

SCALA DISTANZE 1:200  
SCALA QUOTE 1:200

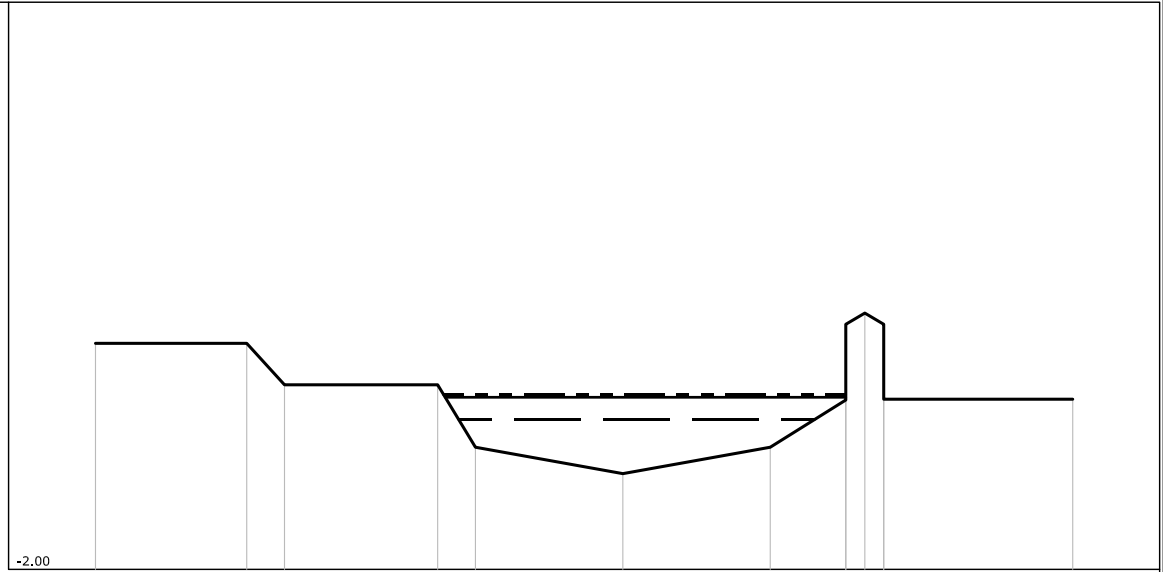

PUNTI	1	2	3	4	5	6	7	8	10	11	13
QUOTE [m s.l.m.]	3.98	3.98	2.88	2.88	1.23	0.53	1.23	2.48	4.78	4.48	2.50
DISTANZE PROGRESSIVE [m]	0.00	4.00	5.00	9.05	10.05	13.95	17.85	19.85	20.35	20.85	25.85
DISTANZE PARZIALI [m]		4.00	1.00	4.05	1.00	3.90	3.90	2.00			5.00

Fosso Maestra  
SEZIONE N° 00012\_\_06

LEGENDA:

- TR30 H = 1.95 m. s.l.m.
- TR200 H = 2.56 m. s.l.m.
- TR500 H = 2.62 m. s.l.m.

SCALA DISTANZE 1:200  
SCALA QUOTE 1:200

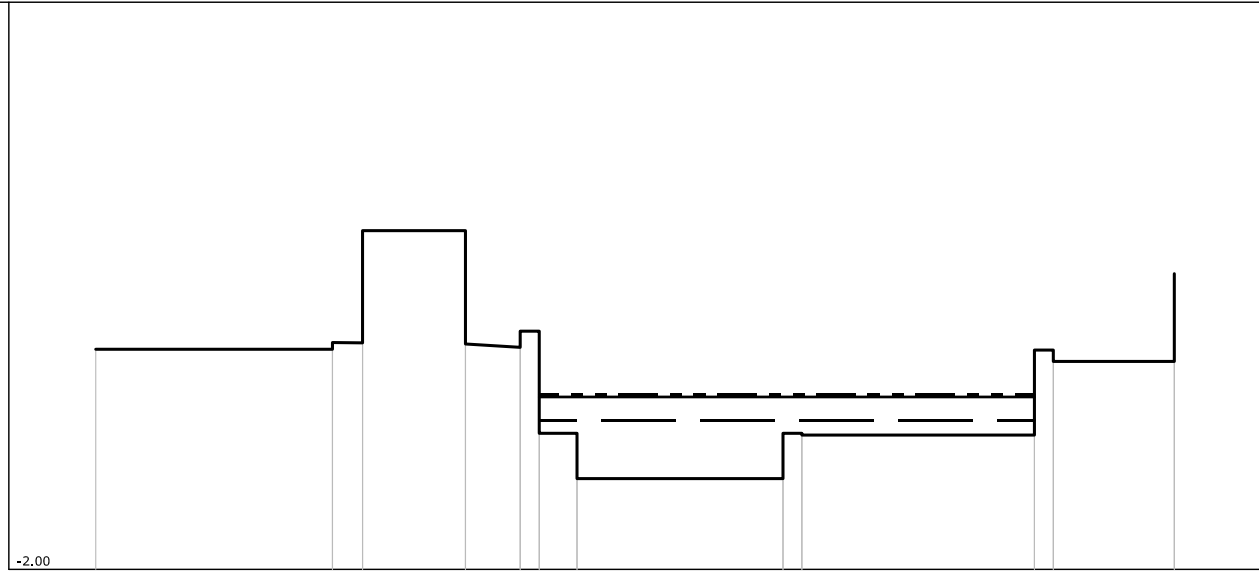



PUNTI	1	2	4	6	8	10	12	14	16	18	20	22
QUOTE [m s.l.m.]	3.82	3.82	3.99	6.96	3.87	4.30	1.60	0.40	1.60	1.55	3.80	3.50
DISTANZE PROGRESSIVE [m]	0.00	6.26	7.06	9.78	11.23	11.73	12.73	18.18	18.68	24.83	25.33	28.53
DISTANZE PARZIALI [m]		6.26		2.72	1.45	1.00	5.45			6.15		3.20

Fosso Maestra  
SEZIONE N° 00010PA06

LEGENDA:

TR30 H =1.95 m. s.l.m. 

TR200 H =2.56 m. s.l.m. 

TR500 H =2.62 m. s.l.m. 

SCALA DISTANZE 1:200  
SCALA QUOTE 1:200

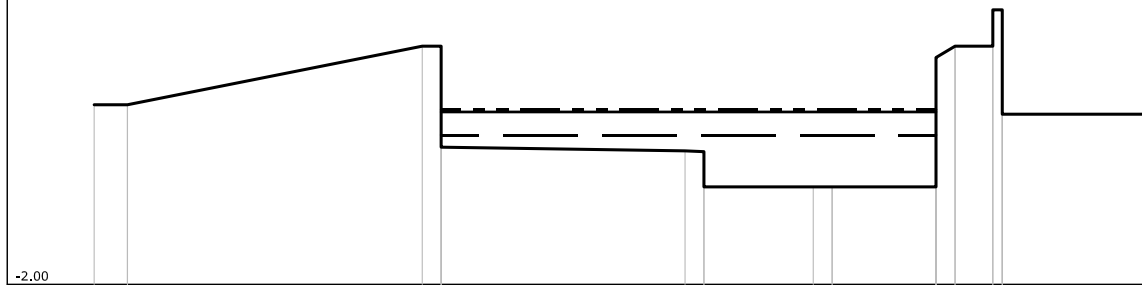



PUNTI	1	2		4	5		8	9		11	12		14	18	20	2		25
QUOTE [m s.l.m.]	2.75	2.75		4.30	4.30		1.53	1.51		0.58	0.58		0.58	4.30	4.30	5.26		2.50
DISTANZE PROGRESSIVE [m]	0.00	0.88		8.68	9.18		15.63	16.13		19.02	19.52		22.27	22.77	23.77	24.02		27.77
DISTANZE PARZIALI [m]			7.80			6.45			2.89		2.75		1.00		3.75			

Fosso Maestra  
SEZIONE N° 00010PB06

LEGENDA:

TR30 H =1.95 m. s.l.m. 

TR200 H =2.56 m. s.l.m. 

TR500 H =2.62 m. s.l.m. 

SCALA DISTANZE 1:200  
SCALA QUOTE 1:200

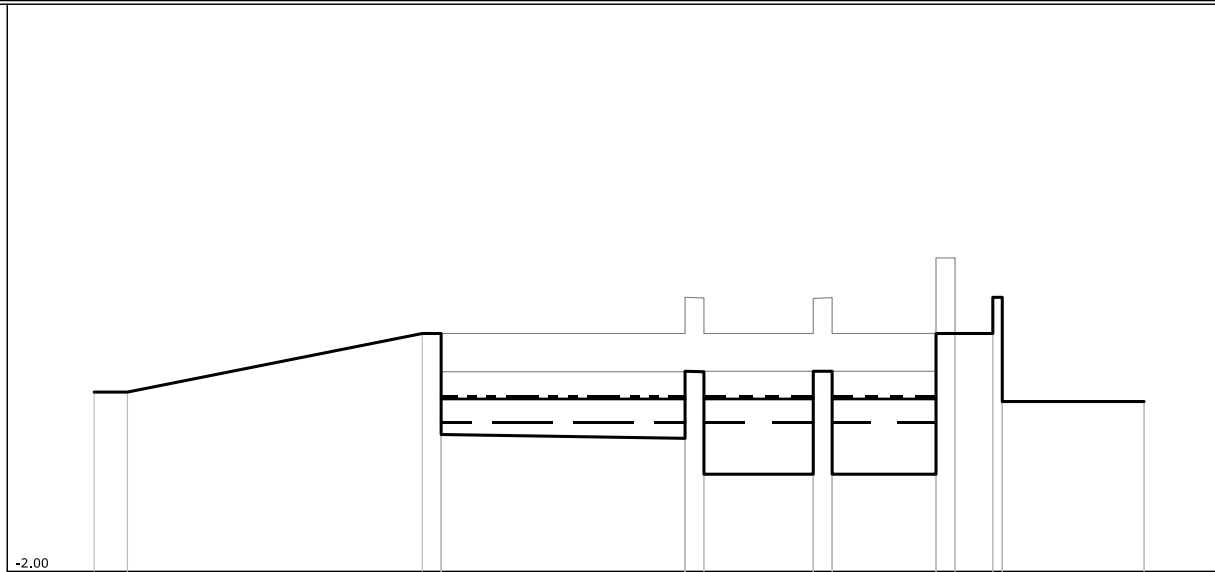



PUNTI	1	2		4	5		8	12		14	17		20	23	27		30
QUOTE [m s.l.m.]	2.74	2.74		4.29	4.29		1.52	3.28		0.57	3.29		0.57	4.29	4.29		2.49
DISTANZE PROGRESSIVE [m]	0.00	0.88		8.68	9.18		15.63	16.13		19.02	19.52		22.27	22.77	23.77		27.77
DISTANZE PARZIALI [m]			7.80			6.45			2.89		2.75		1.00		3.75		

Fosso Maestra  
SEZIONE N° 00010PC06

LEGENDA:

TR30 H =1.23 m. s.l.m. 

TR200 H =1.35 m. s.l.m. 

TR500 H =1.43 m. s.l.m. 

SCALA DISTANZE 1:200  
SCALA QUOTE 1:200

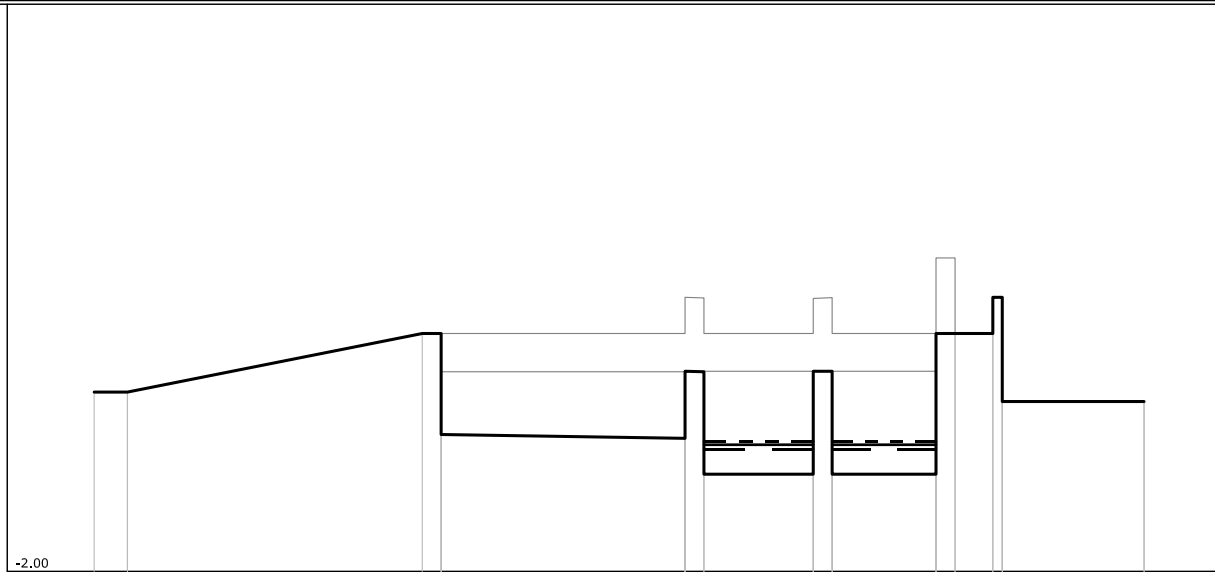



PUNTI	1	2		4	5		8	12		14	17		20	23	27		30
QUOTE [m s.l.m.]	2.74	2.74		4.29	4.29		1.52	3.28		0.57	3.29		0.57	4.29	4.29		2.49
DISTANZE PROGRESSIVE [m]	0.00	0.88		8.68	9.18		15.63	16.13		19.02	19.52		22.27	22.77	23.77		27.77
DISTANZE PARZIALI [m]			7.80			6.45			2.89		2.75		1.00		3.75		

Fosso Maestra  
SEZIONE N° 00010PD06

LEGENDA:

TR30 H = 1.22 m. s.l.m. 

TR200 H = 1.34 m. s.l.m. 

TR500 H = 1.42 m. s.l.m. 

SCALA DISTANZE 1:200  
SCALA QUOTE 1:200

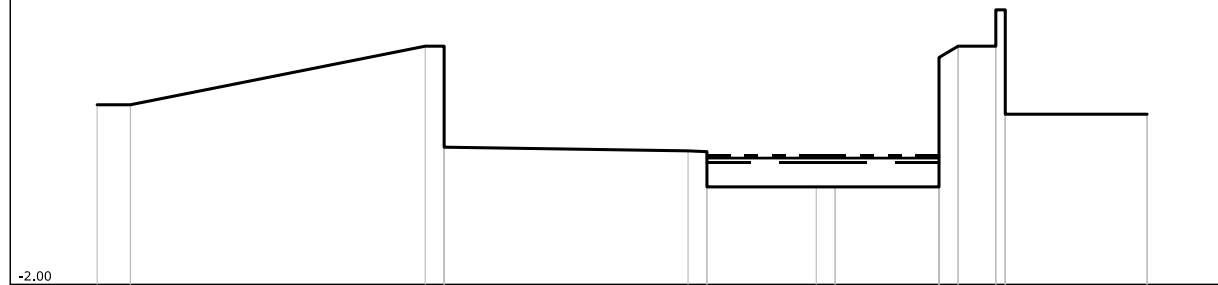

PUNTI	1	2		4	5		8	9		11	12		14	18	20	22		25
QUOTE [m s.l.m.]	2.75	2.75		4.30	4.30		1.53	1.51		0.58	0.58		0.58	4.30	4.30	5.26		2.50
DISTANZE PROGRESSIVE [m]	0.00	0.88		8.68	9.18		15.63	16.13		19.02	19.52		22.27	22.77	23.77	24.02		27.77
DISTANZE PARZIALI [m]			7.80			6.45			2.89		2.75		1.00		3.75			



Fosso Maestra  
 SEZIONE N° 00009\_\_06

LEGENDA:

TR30 H =1.19 m. s.l.m. \_\_\_\_\_

TR200 H =1.27 m. s.l.m. \_\_\_\_\_

TR500 H =1.32 m. s.l.m. - - - - -

SCALA DISTANZE 1:200  
 SCALA QUOTE 1:200

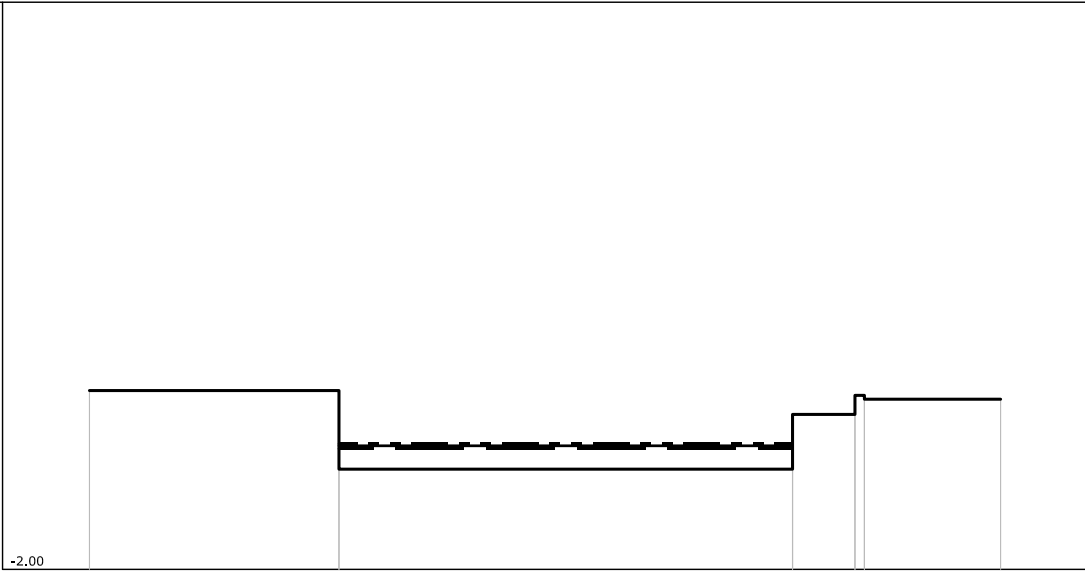



PUNTI	1	2	4	6	8	10
QUOTE [m s.l.m.]	2.73	2.73	0.65	2.10	2.10	2.50
DISTANZE PROGRESSIVE [m]	0.00	6.60	18.60	20.25	20.50	24.10
DISTANZE PARZIALI [m]		6.60	12.00	1.65	3.60	

Fosso Maestra  
 SEZIONE N° 00003\_\_06

LEGENDA:

TR30 H = 1.00 m. s.l.m. 

TR200 H = 1.00 m. s.l.m. 

TR500 H = 1.00 m. s.l.m. 

SCALA DISTANZE 1:200  
 SCALA QUOTE 1:200

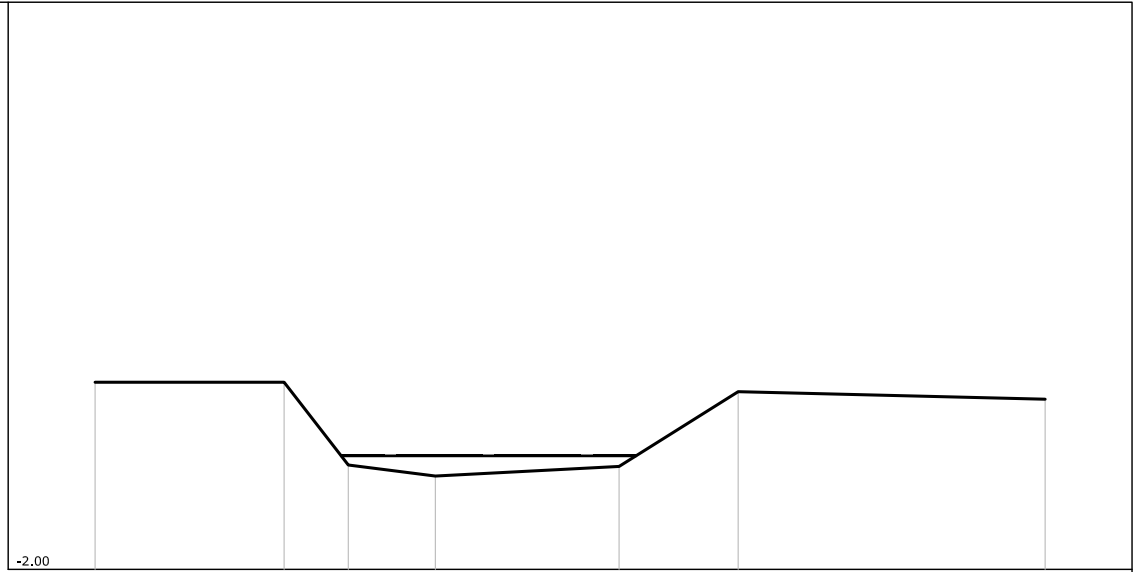

PUNTI	1	2	3	4	5	6	7
QUOTE [m s.l.m.]	2.95	2.95	0.76	0.47	0.72	2.70	2.50
DISTANZE PROGRESSIVE [m]	0.00	5.00	6.70	9.00	13.86	17.01	25.13
DISTANZE PARZIALI [m]		5.00	1.70	2.30	4.86	3.15	8.12

Fosso Carlone 1

Fosso Carlone 1  
 SEZIONE N° 00189\_\_08

LEGENDA:

TR30 H =2.94 m. s.l.m. \_\_\_\_\_

TR200 H =3.03 m. s.l.m. \_\_\_\_\_

TR500 H =3.07 m. s.l.m. - - - - -

SCALA DISTANZE 1:200  
 SCALA QUOTE 1:200

0.00

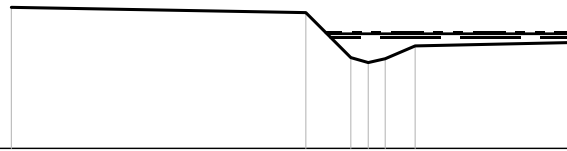

PUNTI	1	2	3	4	5	6	7
QUOTE [m s.l.m.]	3.73	3.59	2.40	2.27	2.37	2.71	2.80
DISTANZE PROGRESSIVE [m]	0.00	7.79	8.98	9.44	9.89	10.68	14.80
DISTANZE PARZIALI [m]		7.79	1.19				4.12

Fosso Carlone 1  
 SEZIONE N° 00185\_\_08

LEGENDA:

TR30 H = 2.70 m. s.l.m. \_\_\_\_\_

TR200 H = 2.70 m. s.l.m. \_\_\_\_\_

TR500 H = 2.76 m. s.l.m. - - - - -

SCALA DISTANZE 1:200  
 SCALA QUOTE 1:200

0.00

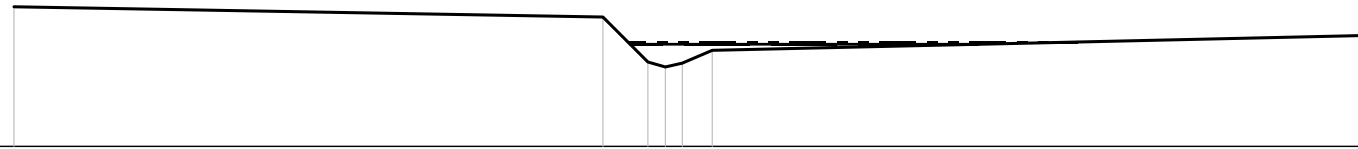



PUNTI	1	2	3	4	5	6	7
QUOTE [m s.l.m.]	3.69	3.42	2.23	2.10	2.20	2.54	2.93
DISTANZE PROGRESSIVE [m]	0.00	15.58	16.77	17.23	17.68	18.47	35.61
DISTANZE PARZIALI [m]		15.58	1.19				17.14

Fosso Carlone 1  
 SEZIONE N° 00179\_\_08

LEGENDA:

TR30 H = 2.49 m. s.l.m. 

TR200 H = 2.66 m. s.l.m. 

TR500 H = 2.74 m. s.l.m. 

SCALA DISTANZE 1:200  
 SCALA QUOTE 1:200

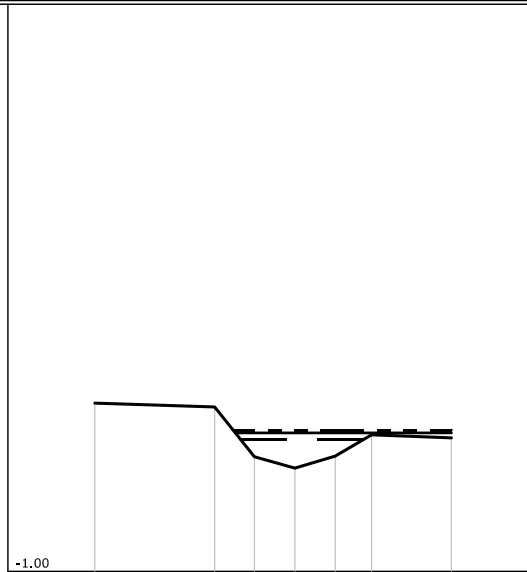



PUNTI	1	2	3	4	5	6	7
QUOTE [m s.l.m.]	3.45	3.35	2.03	1.73	2.05	2.61	2.53
DISTANZE PROGRESSIVE [m]	0.00	3.17	4.22	5.29	6.36	7.32	9.43
DISTANZE PARZIALI [m]		3.17	1.05	1.07	1.07	2.11	

Fosso Carlone 1  
 SEZIONE N° 00177\_\_08

LEGENDA:

TR30 H =2.47 m. s.l.m. 

TR200 H =2.63 m. s.l.m. 

TR500 H =2.74 m. s.l.m. 

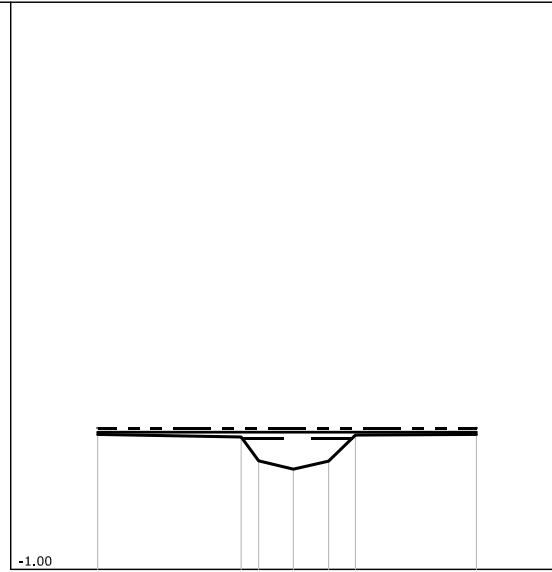

SCALA DISTANZE 1:200  
 SCALA QUOTE 1:200

PUNTI	1	2	3	4	5	6	7
QUOTE [m s.l.m.]	2.57	2.50	1.87	1.65	1.86	2.55	2.57
DISTANZE PROGRESSIVE [m]	0.00	3.80	4.26	5.18	6.11	6.82	10.02
DISTANZE PARZIALI [m]		3.80					3.20

Fosso Carlone 1  
 SEZIONE N° 00167\_\_08

LEGENDA:

- TR30 H =2.43 m. s.l.m.
- TR200 H =2.59 m. s.l.m.
- TR500 H =2.74 m. s.l.m.

SCALA DISTANZE 1:200  
 SCALA QUOTE 1:200

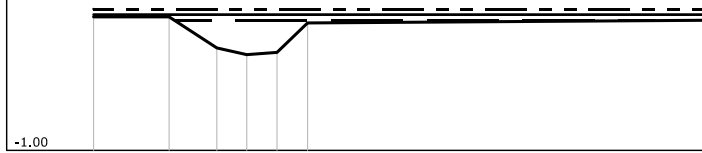



PUNTI	1	2	3	4	5	6	7
QUOTE [m s.l.m.]	2.53	2.53	1.71	1.53	1.59	2.37	2.44
DISTANZE PROGRESSIVE [m]	0.00	2.00	3.26	4.05	4.85	5.66	16.37
DISTANZE PARZIALI [m]		2.00	1.26				10.71



Fosso Carlone 1  
 SEZIONE N° 00163\_\_08

LEGENDA:

TR30 H = 2.40 m. s.l.m. 

TR200 H = 2.59 m. s.l.m. 

TR500 H = 2.74 m. s.l.m. 

SCALA DISTANZE 1:200  
 SCALA QUOTE 1:200

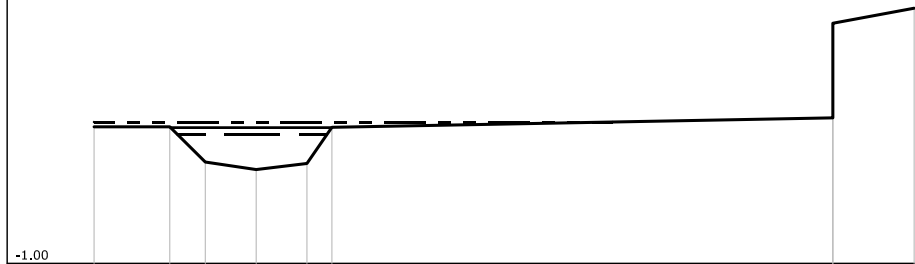

PUNTI	1	2	3	4	5	6	7	9
QUOTE [m s.l.m.]	2.61	2.61	1.68	1.48	1.64	2.60	2.85	5.75
DISTANZE PROGRESSIVE [m]	0.00	2.00	2.94	4.29	5.63	6.29	19.54	21.69
DISTANZE PARZIALI [m]		2.00	1.35	1.34		13.25	2.15	

Fosso Carlone 1  
 SEZIONE N° 00156\_\_08

LEGENDA:

TR30 H =2.38 m. s.l.m. 

TR200 H =2.59 m. s.l.m. 

TR500 H =2.74 m. s.l.m. 

SCALA DISTANZE 1:200  
 SCALA QUOTE 1:200

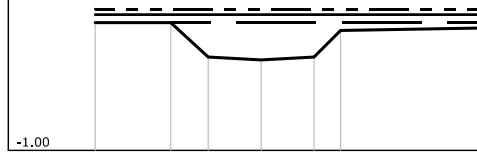



PUNTI	1	2	3	4	5	6	7
QUOTE [m s.l.m.]	2.38	2.38	1.47	1.39	1.47	2.17	2.24
DISTANZE PROGRESSIVE [m]	0.00	2.00	2.99	4.39	5.79	6.49	10.36
DISTANZE PARZIALI [m]		2.00	0.99	1.40	1.40		3.87

Fosso Carlone 1  
 SEZIONE N° 00147\_\_08

LEGENDA:

TR30 H =2.37 m. s.l.m. 

TR200 H =2.59 m. s.l.m. 

TR500 H =2.74 m. s.l.m. 

SCALA DISTANZE 1:200  
 SCALA QUOTE 1:200

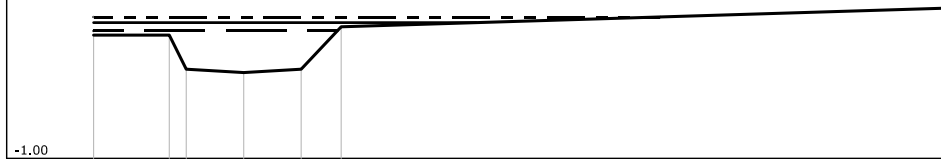

PUNTI	1	2	3	4	5	6	7
QUOTE [m s.l.m.]	2.26	2.26	1.36	1.27	1.36	2.48	2.98
DISTANZE PROGRESSIVE [m]	0.00	2.00	2.45	3.97	5.49	6.55	22.77
DISTANZE PARZIALI [m]		2.00	1.52	1.52	1.06	16.22	

Fosso Carlone 1  
 SEZIONE N° 00139\_\_08

LEGENDA:

- TR30 H = 2.37 m. s.l.m.
- TR200 H = 2.60 m. s.l.m.
- TR500 H = 2.74 m. s.l.m.

SCALA DISTANZE 1:200  
 SCALA QUOTE 1:200

-1.00

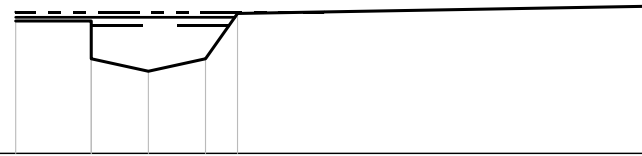



PUNTI	1	2	4	5	6	7
QUOTE [m s.l.m.]	2.50	2.50	1.17	1.50	2.70	2.89
DISTANZE PROGRESSIVE [m]	0.00	2.00	3.51	5.02	5.87	16.74
DISTANZE PARZIALI [m]		2.00	1.51	1.51		10.87

Fosso Carlone 1  
 SEZIONE N° 00137PA08

LEGENDA:

TR30 H =2.37 m. s.l.m. 

TR200 H =2.59 m. s.l.m. 

TR500 H =2.74 m. s.l.m. 

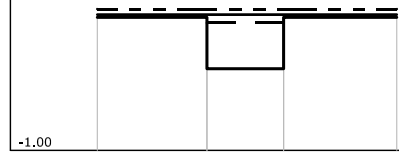



SCALA DISTANZE 1:200  
 SCALA QUOTE 1:200

PUNTI	1	2	4	6
QUOTE [m s.l.m.]	2.52	2.52	1.16	2.52
DISTANZE PROGRESSIVE [m]	0.00	2.90	4.93	7.92
DISTANZE PARZIALI [m]		2.90	2.03	2.99

Fosso Carlone 1  
 SEZIONE N° 00137PB08

LEGENDA:

TR30 H =2.37 m. s.l.m. 

TR200 H =2.59 m. s.l.m. 

TR500 H =2.74 m. s.l.m. 

SCALA DISTANZE 1:200  
 SCALA QUOTE 1:200

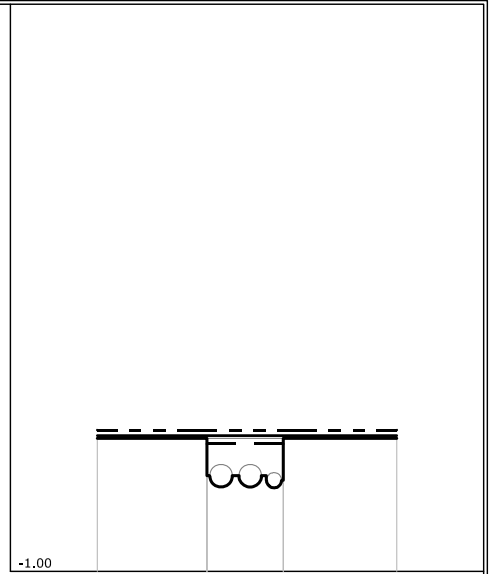

PUNTI	1	228	254	103	95	184
QUOTE [m s.l.m.]	2.52	2.52	1.52	1.52	1.52	2.52
DISTANZE PROGRESSIVE [m]	0.00	2.90	3.15	3.41	3.67	7.92
DISTANZE PARZIALI [m]		2.90				3.00

Fosso Carlone 1  
 SEZIONE N° 00137PC08

LEGENDA:

- TR30 H =2.01 m. s.l.m.
- TR200 H =2.60 m. s.l.m.
- TR500 H =2.74 m. s.l.m.

SCALA DISTANZE 1:200  
 SCALA QUOTE 1:200

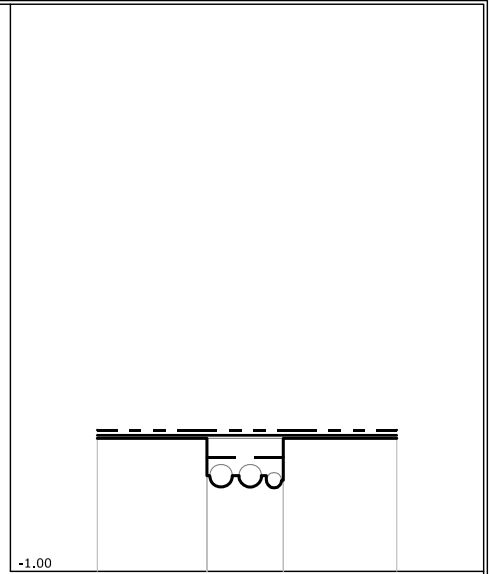



PUNTI	1	228.25410395	184
QUOTE [m s.l.m.]	2.52	2.52 1.26 1.26 1.26 1.26 1.26	2.52
DISTANZE PROGRESSIVE [m]	0.00	2.90 3.16 3.41 3.67 3.92	7.92
DISTANZE PARZIALI [m]		2.90	3.00

Fosso Carlone 1  
 SEZIONE N° 00137PD08

LEGENDA:

TR30 H =2.01 m. s.l.m. 

TR200 H =2.59 m. s.l.m. 

TR500 H =2.74 m. s.l.m. 

SCALA DISTANZE 1:200  
 SCALA QUOTE 1:200

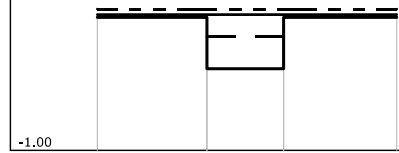

PUNTI	1	2	4	6
QUOTE [m s.l.m.]	2.52	2.52	1.16	2.52
DISTANZE PROGRESSIVE [m]	0.00	2.90	4.93	7.92
DISTANZE PARZIALI [m]		2.90	2.03	2.99



Fosso Carlone 1  
 SEZIONE N° 00136\_\_08

LEGENDA:

TR30 H = 2.01 m. s.l.m. 

TR200 H = 2.60 m. s.l.m. 

TR500 H = 2.74 m. s.l.m. 

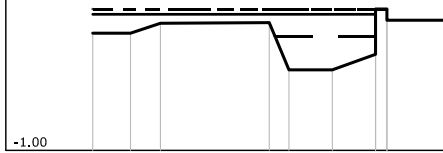

SCALA DISTANZE 1:200  
 SCALA QUOTE 1:200

PUNTI	1	2	3	4	5	6	7	9	11
QUOTE [m s.l.m.]	2.10	2.10	2.36	2.38	1.13	1.13	1.54	2.74	2.44
DISTANZE PROGRESSIVE [m]	0.00	1.00	1.79	4.67	5.19	6.34	7.48	7.98	9.33
DISTANZE PARZIALI [m]	1.00		2.88		1.15	1.14		1.55	

Fosso Carlone 1  
 SEZIONE N° 00130\_\_08

LEGENDA:

TR30 H = 2.01 m. s.l.m. \_\_\_\_\_

TR200 H = 2.60 m. s.l.m. \_\_\_\_\_

TR500 H = 2.74 m. s.l.m. - - - - -

SCALA DISTANZE 1:200  
 SCALA QUOTE 1:200

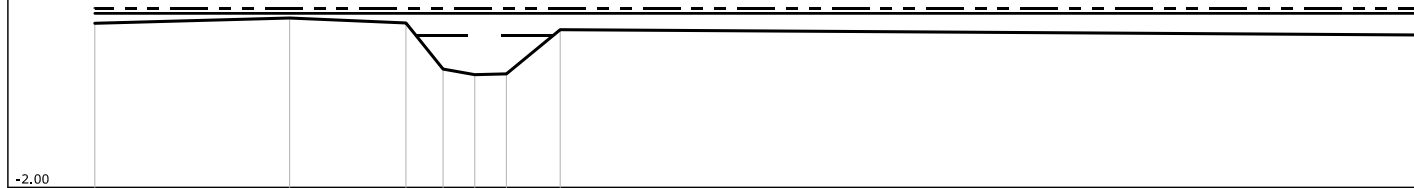

PUNTI	1	2	3	4	5	6	7	8
QUOTE [m s.l.m.]	2.34	2.48	2.35	1.13	0.98	1.00	2.17	2.03
DISTANZE PROGRESSIVE [m]	0.00	5.15	8.23	9.21	10.05	10.89	12.31	34.98
DISTANZE PARZIALI [m]		5.15	3.08	0.98		1.42	22.67	

Fosso Carlone 1  
 SEZIONE N° 00121\_08

LEGENDA:

- TR30 H =2.01 m. s.l.m.
- TR200 H =2.59 m. s.l.m.
- TR500 H =2.74 m. s.l.m.

SCALA DISTANZE 1:200  
 SCALA QUOTE 1:200

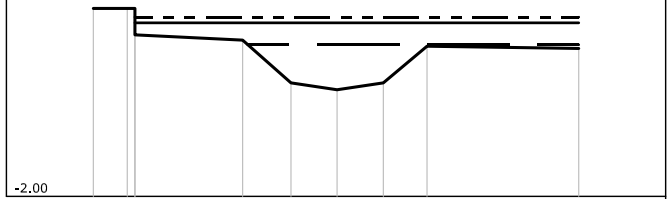

PUNTI	1	2	5	6	7	8	9	10
QUOTE [m s.l.m.]	2.97	2.97	2.13	1.00	0.82	1.00	1.97	1.91
DISTANZE PROGRESSIVE [m]	0.00	0.90	3.95	5.23	6.45	7.67	8.83	12.84
DISTANZE PARZIALI [m]			2.85	1.28	1.22	1.22	1.16	4.01

Fosso Carlone 1  
 SEZIONE N° 00115\_\_08

LEGENDA:

- TR30 H =2.01 m. s.l.m.
- TR200 H =2.60 m. s.l.m.
- TR500 H =2.74 m. s.l.m.

SCALA DISTANZE 1:200  
 SCALA QUOTE 1:200

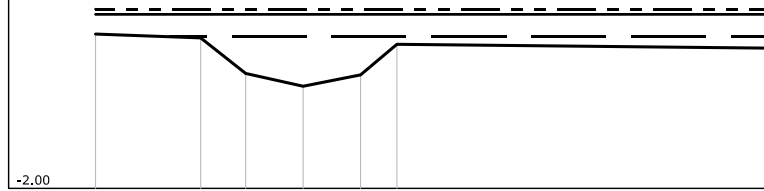

PUNTI	1	2	3	4	5	6	7
QUOTE [m s.l.m.]	2.08	1.98	1.04	0.70	1.00	1.81	1.71
DISTANZE PROGRESSIVE [m]	0.00	2.78	3.97	5.49	7.01	7.97	17.80
DISTANZE PARZIALI [m]		2.78	1.19	1.52	1.52	0.96	9.83

Fosso Carlone 1  
 SEZIONE N° 00110\_\_08

LEGENDA:

- TR30 H =2.01 m. s.l.m.
- TR200 H =2.59 m. s.l.m.
- TR500 H =2.74 m. s.l.m.

SCALA DISTANZE 1:200  
 SCALA QUOTE 1:200

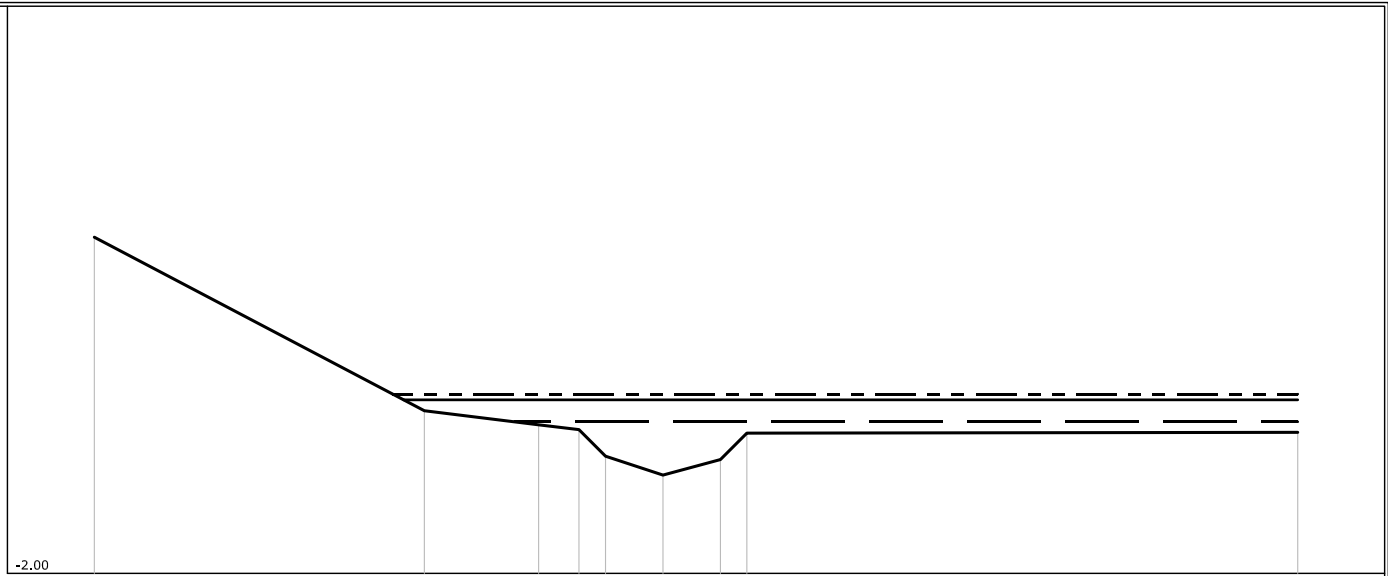

PUNTI	1	2	3	4	5	6	7	8	9
QUOTE [m s.l.m.]	6.89	2.30	1.93	1.80	1.10	0.60	1.01	1.71	1.73
DISTANZE PROGRESSIVE [m]	0.00	8.73	11.75	12.82	13.52	15.04	16.56	17.26	31.83
DISTANZE PARZIALI [m]		8.73	3.02	1.07	1.52	1.52			14.57

Fosso Carlone 1  
 SEZIONE N° 00104\_\_08

LEGENDA:

- TR30 H = 2.01 m. s.l.m.
- TR200 H = 2.60 m. s.l.m.
- TR500 H = 2.74 m. s.l.m.

SCALA DISTANZE 1:200  
 SCALA QUOTE 1:200

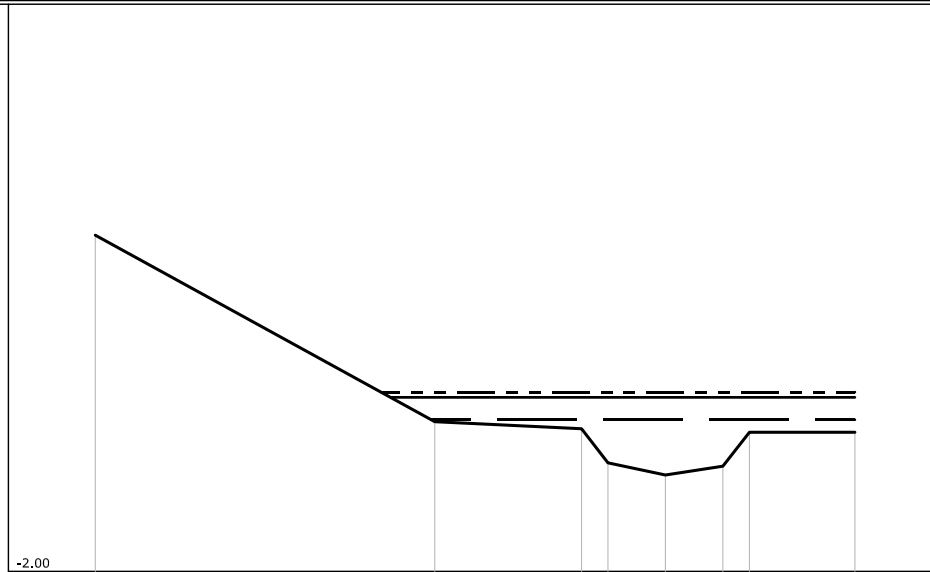

PUNTI	1	2	3	4	5	6	7	8
QUOTE [m s.l.m.]	6.89	1.96	1.77	0.87	0.55	0.78	1.68	1.68
DISTANZE PROGRESSIVE [m]	0.00	8.98	12.86	13.56	15.08	16.60	17.30	20.09
DISTANZE PARZIALI [m]		8.98	3.88		1.52	1.52		2.79

Fosso Carlone 1  
 SEZIONE N° 00102PA08

LEGENDA:

TR30 H = 2.01 m. s.l.m. ———

TR200 H = 2.58 m. s.l.m. ———

TR500 H = 2.74 m. s.l.m. - - - - -

SCALA DISTANZE 1:200  
 SCALA QUOTE 1:200

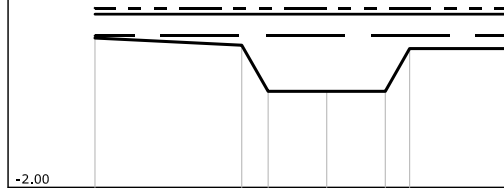

PUNTI	1	2	3	4	5	6	7
QUOTE [m s.l.m.]	1.95	1.76	0.54	0.54	0.54	1.67	1.67
DISTANZE PROGRESSIVE [m]	0.00	3.88	4.58	6.13	7.68	8.32	11.11
DISTANZE PARZIALI [m]		3.88	1.55	1.55		2.79	

Fosso Carlone 1  
 SEZIONE N° 00102PB08

LEGENDA:

TR30 H =2.01 m. s.l.m. ———

TR200 H =2.58 m. s.l.m. ———

TR500 H =2.74 m. s.l.m. - - - - -

SCALA DISTANZE 1:200  
 SCALA QUOTE 1:200

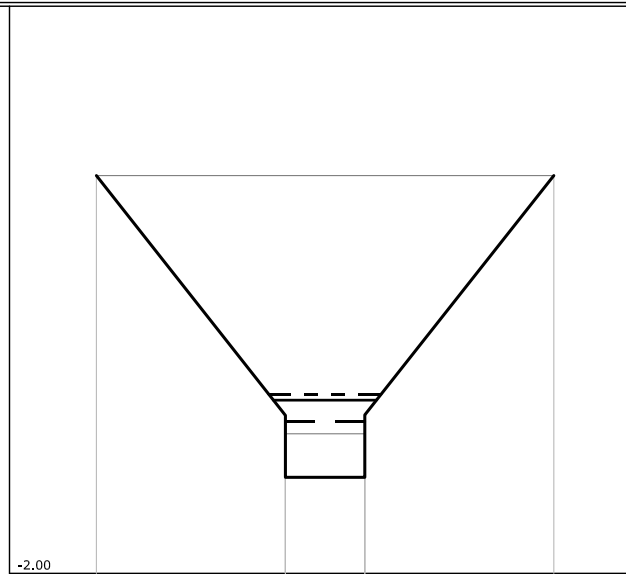

PUNTI	1	2	6	9
QUOTE [m s.l.m.]	8.52	2.18	0.54	8.52
DISTANZE PROGRESSIVE [m]	0.00	5.00	7.10	12.10
DISTANZE PARZIALI [m]		5.00	2.10	5.00



Fosso Carlone 1  
 SEZIONE N° 00102PC08

LEGENDA:

TR30 H =2.03 m. s.l.m. ———

TR200 H =2.62 m. s.l.m. ———

TR500 H =2.76 m. s.l.m. - - - - -

SCALA DISTANZE 1:200  
 SCALA QUOTE 1:200

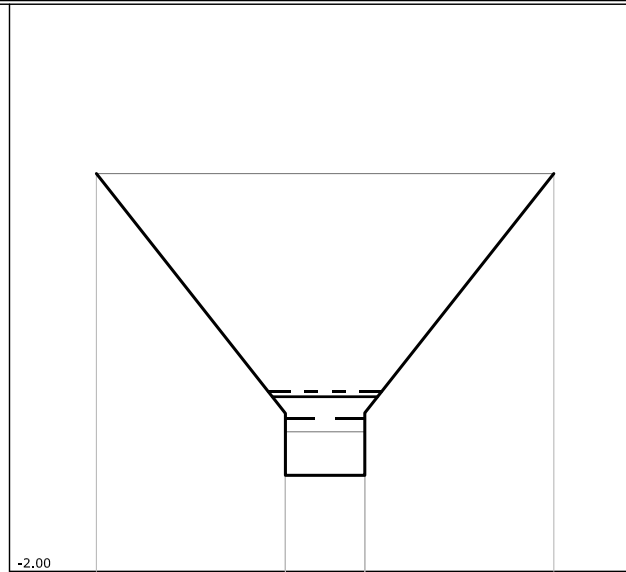

PUNTI	1	2	6	9
QUOTE [m s.l.m.]	8.52	2.18	0.54	8.52
DISTANZE PROGRESSIVE [m]	0.00	5.00	7.10	12.10
DISTANZE PARZIALI [m]		5.00	2.10	5.00

Fosso Carlone 1  
 SEZIONE N° 00102PD08

LEGENDA:

TR30 H = 2.03 m. s.l.m. 

TR200 H = 2.62 m. s.l.m. 

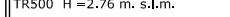
TR500 H = 2.76 m. s.l.m. 

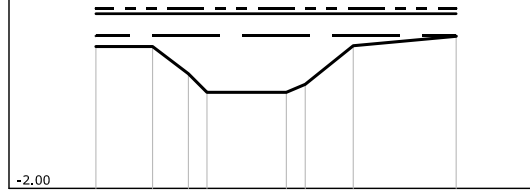

SCALA DISTANZE 1:200  
 SCALA QUOTE 1:200

PUNTI	1	2	3	4	5	6	7	8
QUOTE [m s.l.m.]	1.75	1.75	1.03	0.54	0.54	0.75	1.77	2.02
DISTANZE PROGRESSIVE [m]	0.00	1.50	2.45	2.94	5.04	5.54	6.81	9.53
DISTANZE PARZIALI [m]		1.50			2.10		1.27	2.72

Fosso Carlone 1  
 SEZIONE N° 00094\_\_08

LEGENDA:

TR30 H = 2.03 m. s.l.m. ———

TR200 H = 2.63 m. s.l.m. ———

TR500 H = 2.76 m. s.l.m. - - - - -

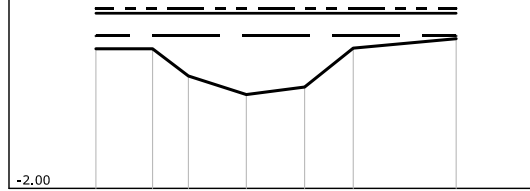

SCALA DISTANZE 1:200  
 SCALA QUOTE 1:200

PUNTI	1	2	3	4	5	6	7
QUOTE [m s.l.m.]	1.69	1.69	0.97	0.48	0.68	1.71	1.96
DISTANZE PROGRESSIVE [m]	0.00	1.50	2.45	3.98	5.52	6.81	9.53
DISTANZE PARZIALI [m]		1.50	1.53	1.54	1.29	2.72	

Fosso Carlone 1  
 SEZIONE N° 00090\_\_08

LEGENDA:

- TR30 H =2.03 m. s.l.m.
- TR200 H =2.63 m. s.l.m.
- TR500 H =2.76 m. s.l.m.

SCALA DISTANZE 1:200  
 SCALA QUOTE 1:200

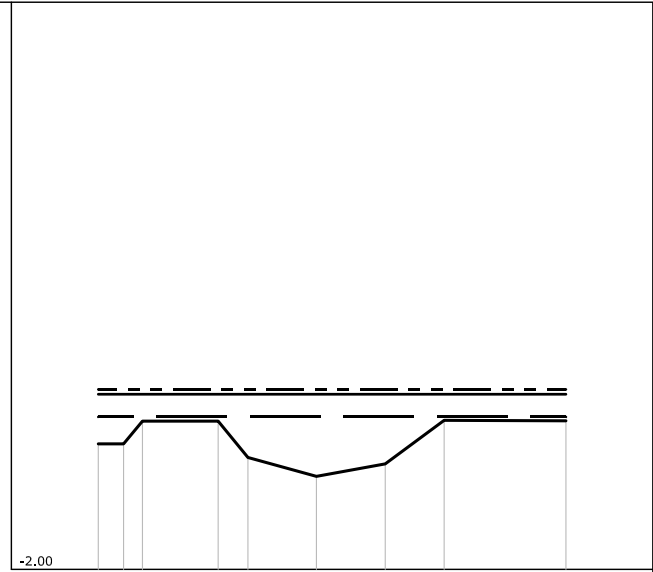



PUNTI	1	2	3	4	5	6	7	8	9
QUOTE [m s.l.m.]	1.32	1.32	1.92	1.92	0.96	0.46	0.79	1.94	1.93
DISTANZE PROGRESSIVE [m]	0.00	0.67	1.17	3.17	3.96	5.77	7.59	9.15	12.37
DISTANZE PARZIALI [m]			2.00		1.81	1.82	1.56	3.22	

Fosso Carlone 1  
 SEZIONE N° 00078\_\_08

LEGENDA:

TR30 H =2.03 m. s.l.m. 

TR200 H =2.63 m. s.l.m. 

TR500 H =2.76 m. s.l.m. 

SCALA DISTANZE 1:200  
 SCALA QUOTE 1:200

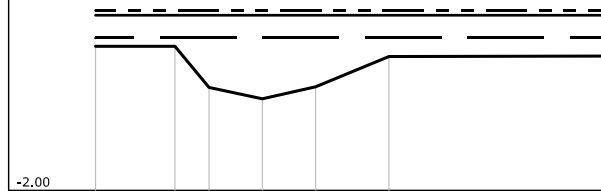

PUNTI	1	2	3	4	5	6	7
QUOTE [m s.l.m.]	1.81	1.81	0.72	0.42	0.74	1.54	1.55
DISTANZE PROGRESSIVE [m]	0.00	2.10	3.00	4.41	5.82	7.76	13.57
DISTANZE PARZIALI [m]		2.10	1.41	1.41	1.94	5.81	

Fosso Carlone 1  
 SEZIONE N° 00070\_\_08

LEGENDA:

TR30 H = 2.03 m. s.l.m. \_\_\_\_\_

TR200 H = 2.63 m. s.l.m. \_\_\_\_\_

TR500 H = 2.76 m. s.l.m. \_\_\_\_\_

SCALA DISTANZE 1:200  
 SCALA QUOTE 1:200

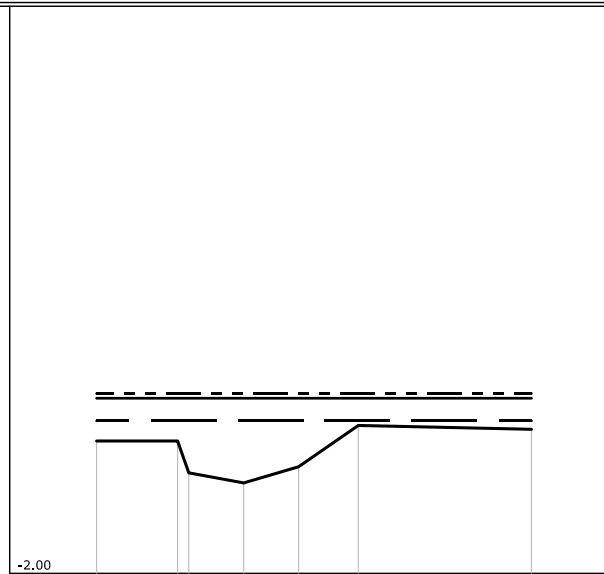

PUNTI	1	2	3	4	5	6	7
QUOTE [m s.l.m.]	1.50	1.50	0.66	0.39	0.82	1.91	1.81
DISTANZE PROGRESSIVE [m]	0.00	2.14	2.44	3.89	5.34	6.92	11.50
DISTANZE PARZIALI [m]		2.14	1.45	1.45	1.58	4.58	

Fosso Carlone 1  
 SEZIONE N° 00059\_\_08

LEGENDA:

- TR30 H =2.04 m. s.l.m.
- TR200 H =2.63 m. s.l.m.
- TR500 H =2.76 m. s.l.m.

SCALA DISTANZE 1:200  
 SCALA QUOTE 1:200

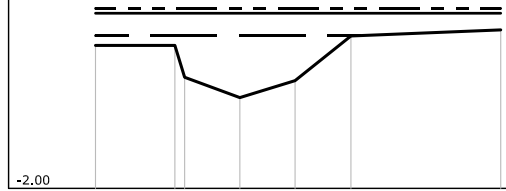

PUNTI	1	2	3	4	5	6	7
QUOTE [m s.l.m.]	1.78	1.78	0.94	0.40	0.85	2.03	2.19
DISTANZE PROGRESSIVE [m]	0.00	2.10	2.36	3.82	5.28	6.76	10.72
DISTANZE PARZIALI [m]		2.10	1.46	1.46	1.48	3.96	

Fosso Carlone 1  
 SEZIONE N° 00047\_\_08

LEGENDA:

- TR30 H = 2.04 m. s.l.m.
- TR200 H = 2.63 m. s.l.m.
- TR500 H = 2.77 m. s.l.m.

SCALA DISTANZE 1:200  
 SCALA QUOTE 1:200

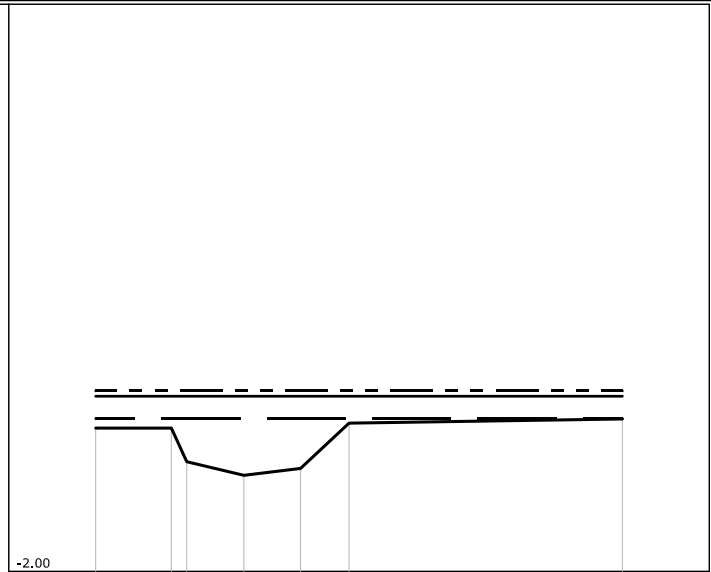

PUNTI	1	2	3	4	5	6	7
QUOTE [m s.l.m.]	1.79	1.79	0.90	0.54	0.72	1.92	2.03
DISTANZE PROGRESSIVE [m]	0.00	2.00	2.41	3.92	5.42	6.70	13.93
DISTANZE PARZIALI [m]		2.00	1.51	1.50	1.28	7.23	



Fosso Carlone 1  
 SEZIONE N° 00041\_\_08

LEGENDA:

- TR30 H = 2.04 m. s.l.m.
- TR200 H = 2.63 m. s.l.m.
- TR500 H = 2.76 m. s.l.m.

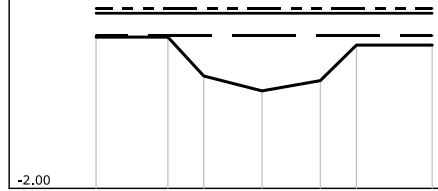



SCALA DISTANZE 1:200  
 SCALA QUOTE 1:200

PUNTI	1	2	3	4	5	6	7
QUOTE [m s.l.m.]	2.00	2.00	0.97	0.58	0.85	1.79	1.79
DISTANZE PROGRESSIVE [m]	0.00	1.90	2.85	4.39	5.93	6.89	8.89
DISTANZE PARZIALI [m]		1.90		1.54	1.54		2.00

Fosso Carlone 1  
 SEZIONE N° 00039\_\_08

LEGENDA:

TR30 H =2.05 m. s.l.m. 

TR200 H =2.63 m. s.l.m. 

TR500 H =2.77 m. s.l.m. 

SCALA DISTANZE 1:200  
 SCALA QUOTE 1:200

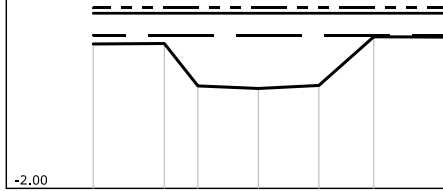



PUNTI	1	2	3	4	5	6	7
QUOTE [m s.l.m.]	1.82	1.83	0.71	0.64	0.72	2.01	2.00
DISTANZE PROGRESSIVE [m]	0.00	1.88	2.77	4.37	5.67	7.42	9.30
DISTANZE PARZIALI [m]		1.88	1.60	1.60	1.45	1.88	

Fosso Carlone 1  
 SEZIONE N° 00038PA08

LEGENDA:

TR30 H = 2.05 m. s.l.m. 

TR200 H = 2.63 m. s.l.m. 

TR500 H = 2.77 m. s.l.m. 

SCALA DISTANZE 1:200  
 SCALA QUOTE 1:200

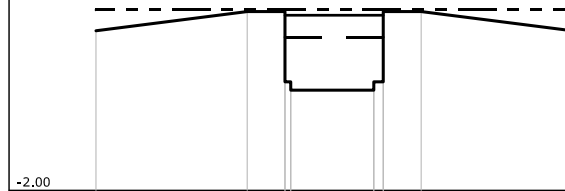



PUNTI	1	2	3	7	9	11	12
QUOTE [m s.l.m.]	2.22	2.73	2.73	2.73	0.65	2.73	2.22
DISTANZE PROGRESSIVE [m]	0.00	4.00	5.00	7.35	7.80	8.60	12.60
DISTANZE PARZIALI [m]		4.00	1.00	2.20	1.00	4.00	

Fosso Carlone 1  
 SEZIONE N° 00038PB08

LEGENDA:

TR30 H = 2.05 m. s.l.m. 

TR200 H = 2.63 m. s.l.m. 

TR500 H = 2.77 m. s.l.m. 

SCALA DISTANZE 1:200  
 SCALA QUOTE 1:200

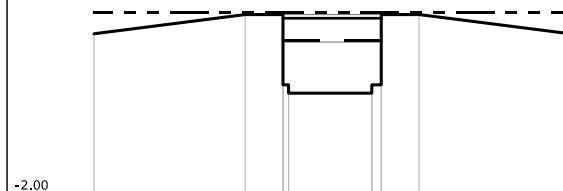



PUNTI	1	2	3	8	10	12	13
QUOTE [m s.l.m.]	2.22	2.73	2.73	0.65	0.85	2.73	2.22
DISTANZE PROGRESSIVE [m]	0.00	4.00	5.00	7.35	7.80	8.60	12.60
DISTANZE PARZIALI [m]		4.00	1.00	2.20	1.00	4.00	

Fosso Carlone 1  
 SEZIONE N° 00038PC08

LEGENDA:

TR30 H = 2.06 m. s.l.m. 

TR200 H = 2.66 m. s.l.m. 

TR500 H = 2.79 m. s.l.m. 

SCALA DISTANZE 1:200  
 SCALA QUOTE 1:200

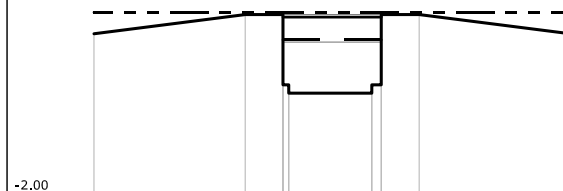



PUNTI	1	2	3	8	10	12	13
QUOTE [m s.l.m.]	2.22	2.73	2.73	0.65	0.85	2.73	2.22
DISTANZE PROGRESSIVE [m]	0.00	4.00	5.00	7.35	7.80	8.60	12.60
DISTANZE PARZIALI [m]		4.00	1.00	2.20	1.00	4.00	

Fosso Carlone 1  
 SEZIONE N° 00038PD08

LEGENDA:

TR30 H = 2.06 m. s.l.m. 

TR200 H = 2.66 m. s.l.m. 

TR500 H = 2.79 m. s.l.m. 

SCALA DISTANZE 1:200  
 SCALA QUOTE 1:200

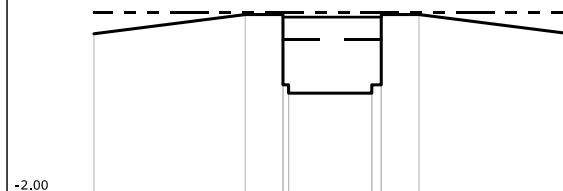



PUNTI	1	2	3	7	9	11	12
QUOTE [m s.l.m.]	2.22	2.73	2.73	2.73	0.65	2.73	2.22
DISTANZE PROGRESSIVE [m]	0.00	4.00	5.00	7.35	7.80	8.60	12.60
DISTANZE PARZIALI [m]		4.00	1.00	2.20	1.00	4.00	

Fosso Carlone 1  
 SEZIONE N° 00037\_\_08

LEGENDA:

TR30 H =2.07 m. s.l.m. 

TR200 H =2.66 m. s.l.m. 

TR500 H =2.79 m. s.l.m. 

SCALA DISTANZE 1:200  
 SCALA QUOTE 1:200

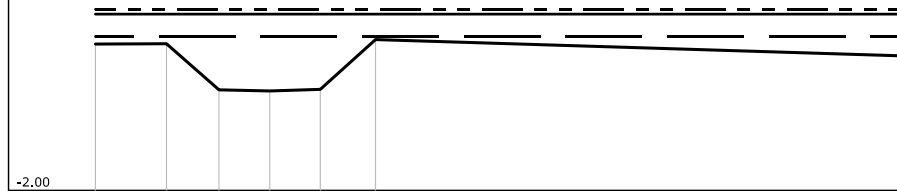

PUNTI	1	2	3	4	5	6	7
QUOTE [m s.l.m.]	1.87	1.88	0.66	0.63	0.67	1.99	1.55
DISTANZE PROGRESSIVE [m]	0.00	1.88	3.27	4.61	5.95	7.41	21.51
DISTANZE PARZIALI [m]		1.88	1.39	1.34	1.34	1.46	14.10

Fosso Carlone 1  
 SEZIONE N° 00033\_\_08

LEGENDA:

TR30 H =2.07 m. s.l.m. \_\_\_\_\_

TR200 H =2.66 m. s.l.m. \_\_\_\_\_

TR500 H =2.79 m. s.l.m. - - - - -

SCALA DISTANZE 1:200  
 SCALA QUOTE 1:200

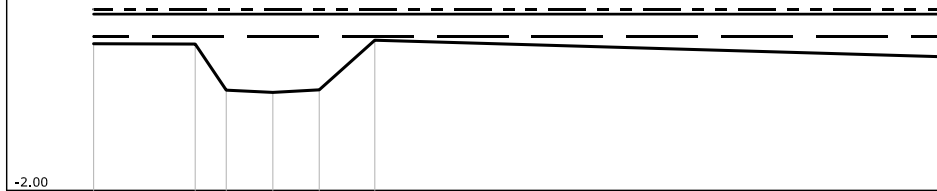



PUNTI	1	2	3	4	5	6	7
QUOTE [m s.l.m.]	1.88	1.87	0.65	0.59	0.66	1.97	1.53
DISTANZE PROGRESSIVE [m]	0.00	2.69	3.51	4.74	5.97	7.44	22.56
DISTANZE PARZIALI [m]		2.69	1.23	1.23	1.47	15.12	



Fosso Carlone 1  
 SEZIONE N° 00020\_\_08

LEGENDA:

TR30 H = 2.07 m. s.l.m. 

TR200 H = 2.66 m. s.l.m. 

TR500 H = 2.79 m. s.l.m. 

SCALA DISTANZE 1:200  
 SCALA QUOTE 1:200

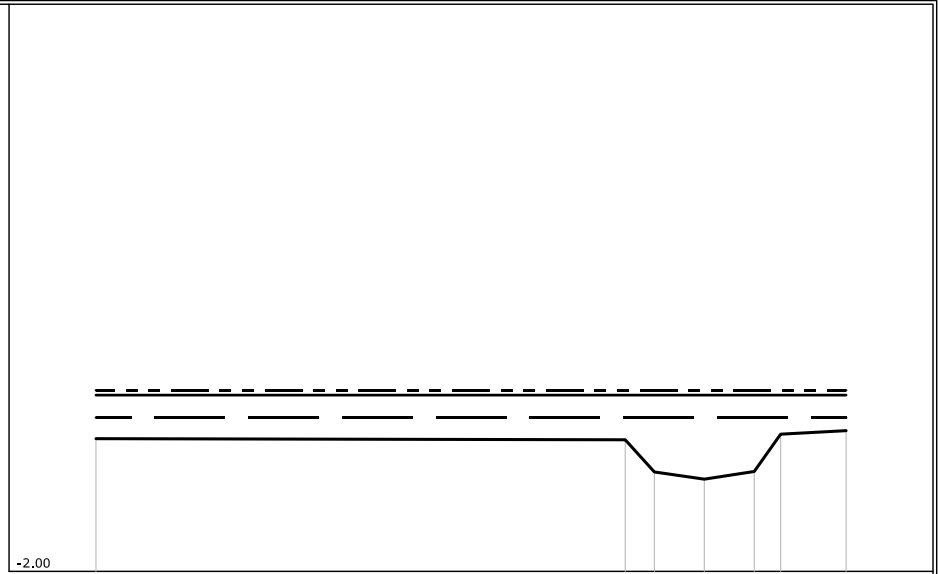

PUNTI	1	2	3	4	5	6	7
QUOTE [m s.l.m.]	1.51	1.48	0.63	0.44	0.64	1.63	1.72
DISTANZE PROGRESSIVE [m]	0.00	14.00	14.77	16.09	17.41	18.11	19.84
DISTANZE PARZIALI [m]		14.00		1.32	1.32		1.73

Fosso Carlone 1  
 SEZIONE N° 00013\_\_08

LEGENDA:

TR30 H = 2.07 m. s.l.m. ———

TR200 H = 2.66 m. s.l.m. ————

TR500 H = 2.79 m. s.l.m. - - - - -

SCALA DISTANZE 1:200  
 SCALA QUOTE 1:200

-2.00

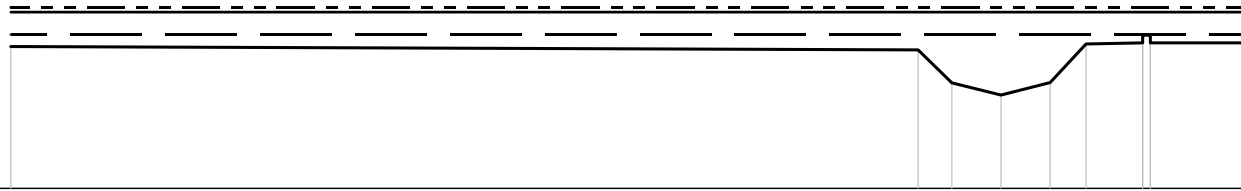



PUNTI	1			2	3	4	5	6	7		11
QUOTE [m s.l.m.]	1.75			1.66	0.79	0.47	0.80	1.82	1.85		1.85
DISTANZE PROGRESSIVE [m]	0.00			24.00	24.89	26.19	27.49	28.44	29.94		32.65
DISTANZE PARZIALI [m]		24.00			1.30	1.30		1.50		2.51	

Fosso Carlone 1  
 SEZIONE N° 00005\_\_08

LEGENDA:

TR30 H = 2.08 m. s.l.m. 

TR200 H = 2.66 m. s.l.m. 

TR500 H = 2.80 m. s.l.m. 

SCALA DISTANZE 1:200  
 SCALA QUOTE 1:200

-2.00

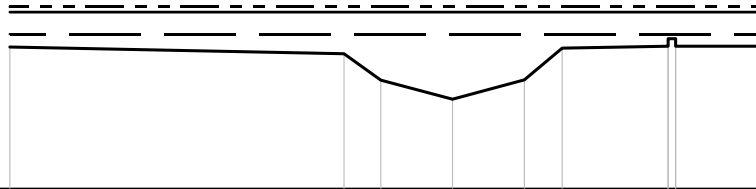



PUNTI	1	2	3	4	5	6	7	11
QUOTE [m s.l.m.]	1.74	1.56	0.86	0.36	0.87	1.71	1.76	1.76
DISTANZE PROGRESSIVE [m]	0.00	8.84	9.81	11.71	13.61	14.61	17.41	20.11
DISTANZE PARZIALI [m]		8.84	0.97	1.90	1.90	1.00	2.80	2.50

Fosso Carlone 2

Fosso Carlone 2  
 SEZIONE N° 00051\_\_08

**LEGENDA:**

TR30 H = 2.15 m. s.l.m. 

TR200 H = 2.98 m. s.l.m. 

TR500 H = 2.98 m. s.l.m. 

SCALA DISTANZE 1:200  
 SCALA QUOTE 1:200

-1.00

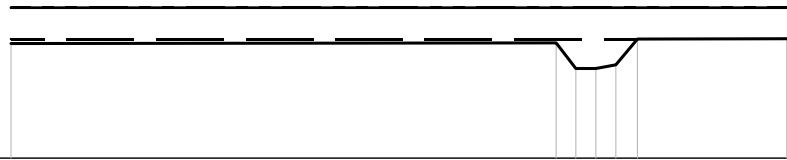



PUNTI	1	2	3	4	5	6	7
QUOTE [m s.l.m.]	2.03	2.05	1.37	1.37	1.47	2.15	2.16
DISTANZE PROGRESSIVE [m]	0.00	14.42	14.94	15.47	16.00	16.57	20.52
DISTANZE PARZIALI [m]		14.42					3.95

Fosso Carlone 2  
 SEZIONE N° 00046\_\_08

LEGENDA:

TR30 H = 2.00 m. s.l.m. 

TR200 H = 2.93 m. s.l.m. 

TR500 H = 2.93 m. s.l.m. 

SCALA DISTANZE 1:200  
 SCALA QUOTE 1:200

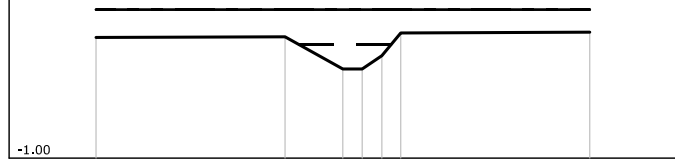

PUNTI	1	2	3	4	5	6	7
QUOTE [m s.l.m.]	2.19	2.21	1.36	1.36	1.71	2.31	2.33
DISTANZE PROGRESSIVE [m]	0.00	5.00	6.53	7.04	7.56	8.06	13.06
DISTANZE PARZIALI [m]		5.00	1.53				5.00

Fosso Carlone 2  
 SEZIONE N° 00043\_\_08

LEGENDA:

- TR30 H =2.00 m. s.l.m.
- TR200 H =2.95 m. s.l.m.
- TR500 H =2.95 m. s.l.m.

SCALA DISTANZE 1:200  
 SCALA QUOTE 1:200

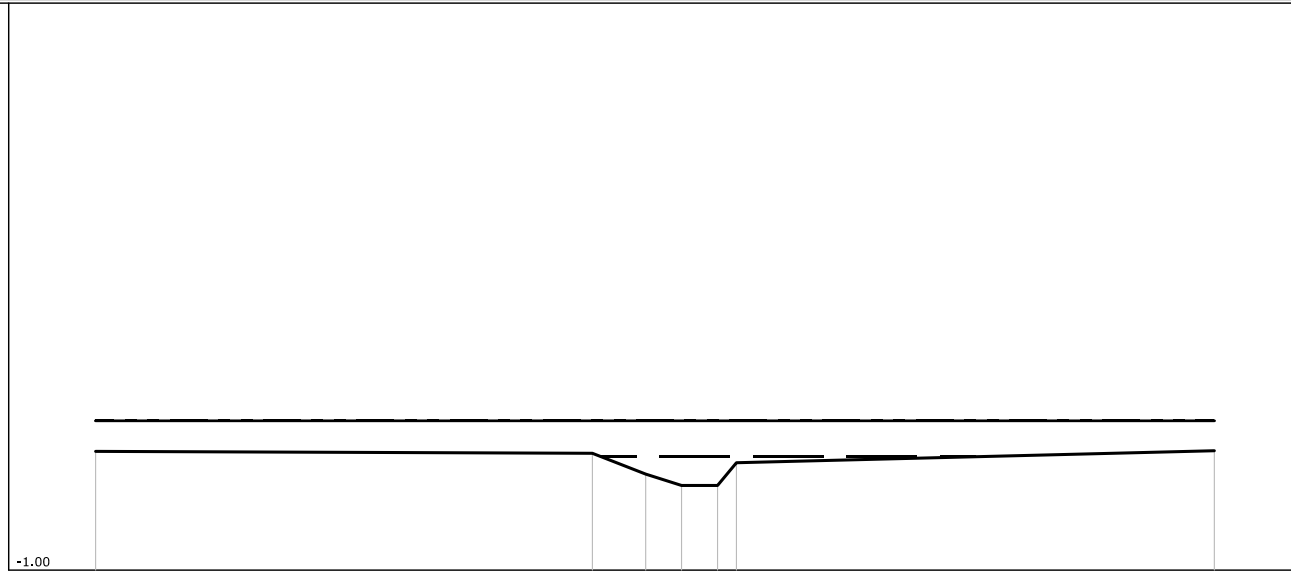

PUNTI	1	2	3	4	5	6	7
QUOTE [m s.l.m.]	2.14	2.09	1.54	1.24	1.24	1.84	2.16
DISTANZE PROGRESSIVE [m]	0.00	13.14	14.55	15.50	16.45	16.95	29.59
DISTANZE PARZIALI [m]		13.14	1.41				12.64

Fosso Carlone 2  
 SEZIONE N° 00041\_\_08

LEGENDA:

TR30 H =2.00 m. s.l.m. ———

TR200 H =2.72 m. s.l.m. ———

TR500 H =2.74 m. s.l.m. - - - - -

SCALA DISTANZE 1:200  
 SCALA QUOTE 1:200

-1.00

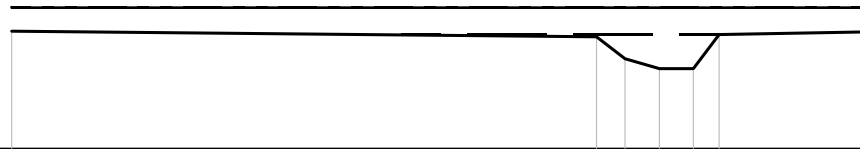

PUNTI	1	2	3	4	5	6	7
QUOTE [m s.l.m.]	2.10	1.95	1.37	1.11	1.11	2.01	2.08
DISTANZE PROGRESSIVE [m]	0.00	15.47	16.22	17.13	18.03	18.71	22.71
DISTANZE PARZIALI [m]		15.47				4.00	



Fosso Carlone 2  
 SEZIONE N° 00040PA08

LEGENDA:

TR30 H =2.00 m. s.l.m. ————

TR200 H =2.78 m. s.l.m. —————

TR500 H =2.78 m. s.l.m. - - - - -

SCALA DISTANZE 1:200  
 SCALA QUOTE 1:200

-1.00

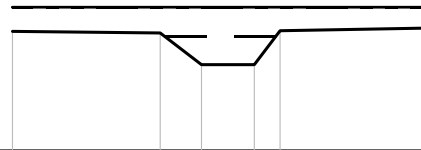



PUNTI	1	2	3	4	5	6
QUOTE [m s.l.m.]	2.14	2.10	1.26	1.26	2.16	2.23
DISTANZE PROGRESSIVE [m]	0.00	3.91	5.00	6.40	7.08	11.08
DISTANZE PARZIALI [m]		3.91	1.09	1.40		4.00

Fosso Carlone 2  
 SEZIONE N° 00040PB08

LEGENDA:

TR30 H = 2,00 m. s.l.m. 

TR200 H = 2,76 m. s.l.m. 

TR500 H = 2,76 m. s.l.m. 

SCALA DISTANZE 1:200  
 SCALA QUOTE 1:200

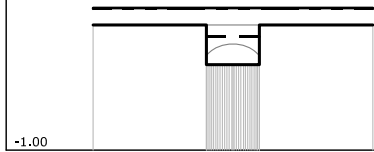



PUNTI	1	28 13 27	31
QUOTE [m s.l.m.]	2.31	2.31 1.26 1.26 1.26 1.26	2.31
DISTANZE PROGRESSIVE [m]	0.00	3.00 3.00 3.00 3.00 3.00	7.40
DISTANZE PARZIALI [m]		3.00	3.00

Fosso Carlone 2  
 SEZIONE N° 00040PC08

LEGENDA:

TR30 H =2.01 m. s.l.m. 

TR200 H =2.66 m. s.l.m. 

TR500 H =2.74 m. s.l.m. 

SCALA DISTANZE 1:200  
 SCALA QUOTE 1:200

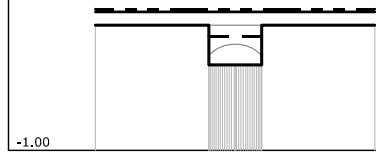

PUNTI	1	28 13 28	31
QUOTE [m s.l.m.]	2.31	2.31 1.26 1.26 1.26	2.31
DISTANZE PROGRESSIVE [m]	0.00	3.00 3.29 3.79 4.08	7.39
DISTANZE PARZIALI [m]		3.00	2.99

Fosso Carlone 2  
 SEZIONE N° 00040PD08

LEGENDA:

TR30 H =2.01 m. s.l.m. ———

TR200 H =2.68 m. s.l.m. ———

TR500 H =2.74 m. s.l.m. - - - - -

SCALA DISTANZE 1:200  
 SCALA QUOTE 1:200

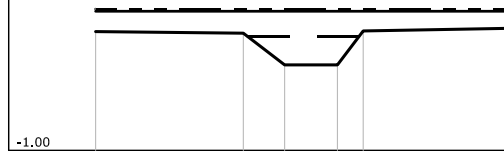

PUNTI	1	2	3	4	5	6
QUOTE [m s.l.m.]	2.14	2.10	1.26	1.26	2.16	2.23
DISTANZE PROGRESSIVE [m]	0.00	3.91	5.00	6.40	7.08	11.08
DISTANZE PARZIALI [m]		3.91	1.09	1.40		4.00

Fosso Carlone 2  
 SEZIONE N° 00038\_\_08

LEGENDA:

TR30 H =2.01 m. s.l.m. ———

TR200 H =2.72 m. s.l.m. ———

TR500 H =2.74 m. s.l.m. - - - - -

SCALA DISTANZE 1:200  
 SCALA QUOTE 1:200

-1.00

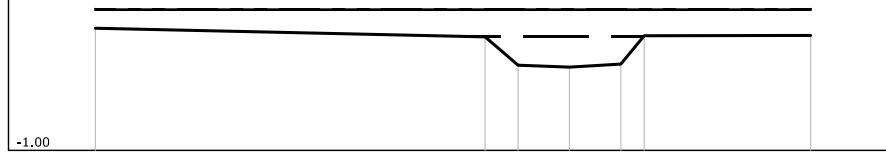



PUNTI	1	2	3	4	5	6	7
QUOTE [m s.l.m.]	2.23	2.00	1.25	1.20	1.28	2.03	2.04
DISTANZE PROGRESSIVE [m]	0.00	10.31	11.18	12.54	13.90	14.52	18.92
DISTANZE PARZIALI [m]		10.31	1.36	1.36		4.40	

Fosso Carlone 2  
 SEZIONE N° 00037PA08

LEGENDA:

TR30 H = 2.01 m. s.l.m. 

TR200 H = 2.69 m. s.l.m. 

TR500 H = 2.74 m. s.l.m. 

SCALA DISTANZE 1:200  
 SCALA QUOTE 1:200

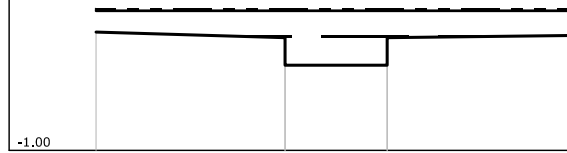



PUNTI	1	2	4	6
QUOTE [m s.l.m.]	2.13	1.98	1.25	2.04
DISTANZE PROGRESSIVE [m]	0.00	5.00	7.70	12.70
DISTANZE PARZIALI [m]		5.00	2.70	5.00

Fosso Carlone 2  
 SEZIONE N° 00037PB08

LEGENDA:

TR30 H = 2.01 m. s.l.m. 

TR200 H = 2.70 m. s.l.m. 

TR500 H = 2.74 m. s.l.m. 

SCALA DISTANZE 1:200  
 SCALA QUOTE 1:200

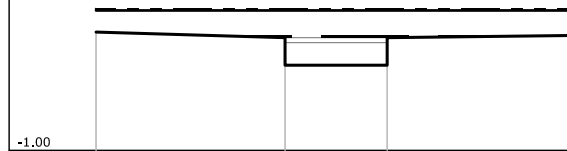



PUNTI	1	3	5	7
QUOTE [m s.l.m.]	2.13	1.98	1.25	2.04
DISTANZE PROGRESSIVE [m]	0.00	5.00	7.70	12.70
DISTANZE PARZIALI [m]		5.00	2.70	5.00

Fosso Carlone 2  
 SEZIONE N° 00037PC08

LEGENDA:

TR30 H = 2.01 m. s.l.m. 

TR200 H = 2.68 m. s.l.m. 

TR500 H = 2.75 m. s.l.m. 

SCALA DISTANZE 1:200  
 SCALA QUOTE 1:200

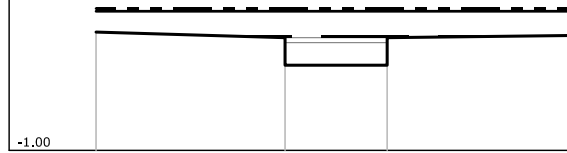



PUNTI	1	3	5	7
QUOTE [m s.l.m.]	2.13	1.98	1.25	2.04
DISTANZE PROGRESSIVE [m]	0.00	5.00	7.70	12.70
DISTANZE PARZIALI [m]		5.00	2.70	5.00



Fosso Carlone 2  
 SEZIONE N° 00037PD08

LEGENDA:

TR30 H = 2.01 m. s.l.m. 

TR200 H = 2.67 m. s.l.m. 

TR500 H = 2.75 m. s.l.m. 

SCALA DISTANZE 1:200  
 SCALA QUOTE 1:200

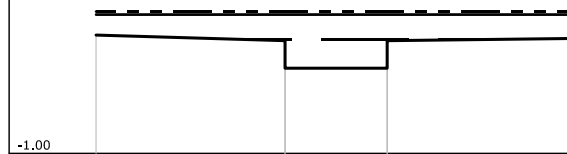



PUNTI	1	2	4	6
QUOTE [m s.l.m.]	2.13	1.98	1.25	2.04
DISTANZE PROGRESSIVE [m]	0.00	5.00	7.70	12.70
DISTANZE PARZIALI [m]		5.00	2.70	5.00

Fosso Carlone 2  
 SEZIONE N° 00035\_\_08

LEGENDA:

TR30 H =2.01 m. s.l.m. 

TR200 H =2.64 m. s.l.m. 

TR500 H =2.75 m. s.l.m. 

SCALA DISTANZE 1:200  
 SCALA QUOTE 1:200

-1.00

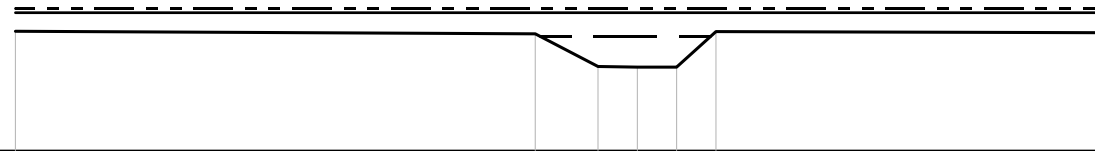

PUNTI	1	2	3	4	5	6	7
QUOTE [m s.l.m.]	2.15	2.08	1.22	1.20	1.20	2.14	2.11
DISTANZE PROGRESSIVE [m]	0.00	13.75	15.41	16.45	17.49	18.53	28.76
DISTANZE PARZIALI [m]		13.75	1.66	1.04	1.04	1.04	10.23

Fosso Carlone 2  
 SEZIONE N° 00030\_\_08

LEGENDA:

TR30 H =2.01 m. s.l.m. \_\_\_\_\_

TR200 H =2.63 m. s.l.m. \_\_\_\_\_

TR500 H =2.75 m. s.l.m. - - - - -

SCALA DISTANZE 1:200  
 SCALA QUOTE 1:200

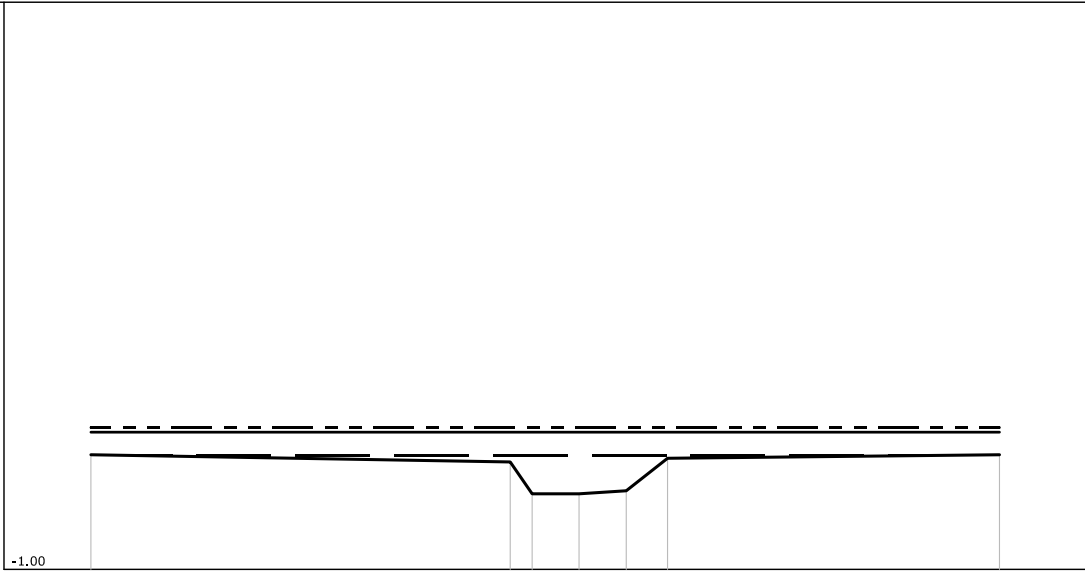

PUNTI	1	2	3	4	5	6	7
QUOTE [m s.l.m.]	2.03	1.84	1.00	1.00	1.08	1.94	2.03
DISTANZE PROGRESSIVE [m]	0.00	11.09	11.67	12.91	14.16	15.25	24.03
DISTANZE PARZIALI [m]		11.09	1.24	1.25	1.09	8.78	

Fosso Carlone 2  
 SEZIONE N° 00026\_\_08

LEGENDA:

TR30 H =2.01 m. s.l.m. ———

TR200 H =2.61 m. s.l.m. ———

TR500 H =2.74 m. s.l.m. - - - - -

SCALA DISTANZE 1:200  
 SCALA QUOTE 1:200

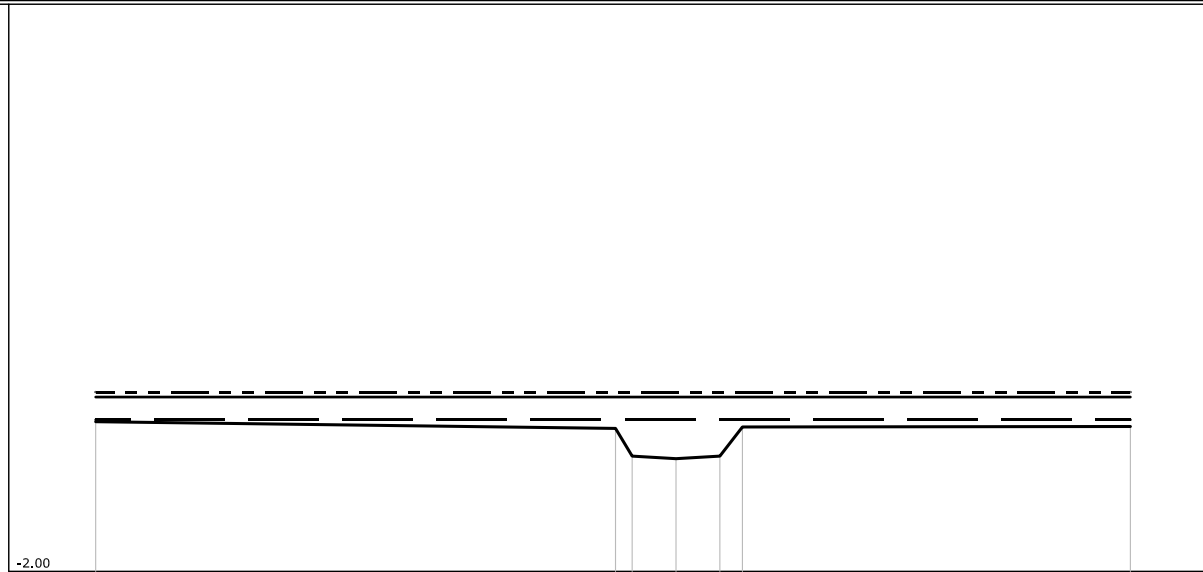

PUNTI	1	2	3	4	5	6	7
QUOTE [m s.l.m.]	1.96	1.78	1.05	0.98	1.05	1.82	1.83
DISTANZE PROGRESSIVE [m]	0.00	13.75	14.19	15.35	16.51	17.11	27.37
DISTANZE PARZIALI [m]		13.75	1.16	1.16		10.26	

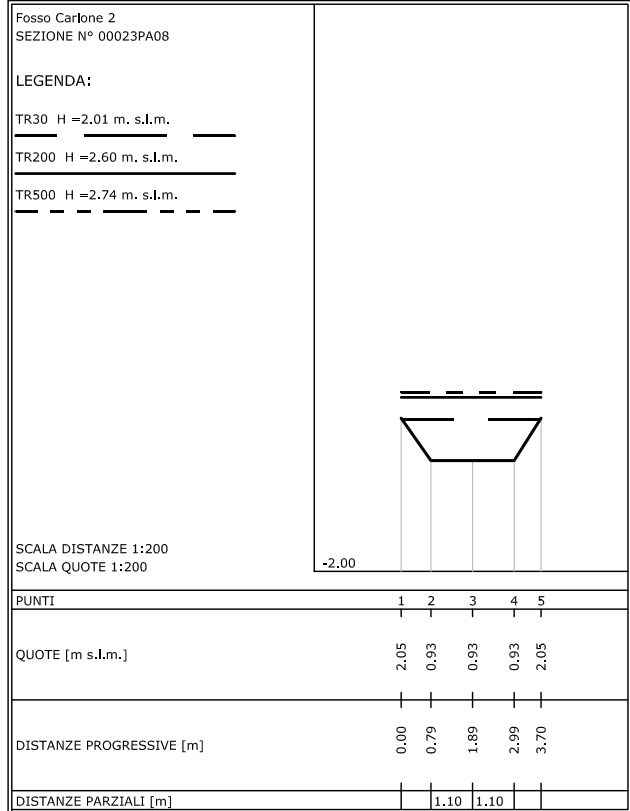

Fosso Carlone 2  
 SEZIONE N° 00023PB08

LEGENDA:

TR30 H =2.01 m. s.l.m. ————

TR200 H =2.60 m. s.l.m. ————

TR500 H =2.74 m. s.l.m. - - - - -

SCALA DISTANZE 1:200  
 SCALA QUOTE 1:200

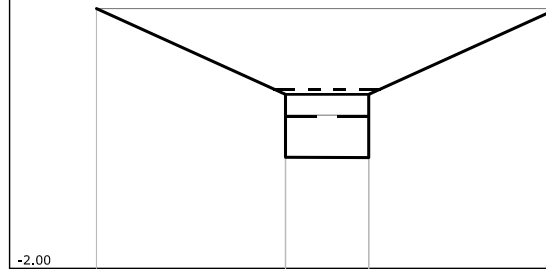

PUNTI	1	2	6	9
QUOTE [m s.l.m.]	4.87	2.60	0.93	4.87
DISTANZE PROGRESSIVE [m]	0.00	5.00	7.20	12.20
DISTANZE PARZIALI [m]		5.00	2.20	5.00

Fosso Carlone 2  
 SEZIONE N° 00023PC08

LEGENDA:

TR30 H =2.02 m. s.l.m. ———

TR200 H =2.62 m. s.l.m. ———

TR500 H =2.76 m. s.l.m. - - - - -

SCALA DISTANZE 1:200  
 SCALA QUOTE 1:200

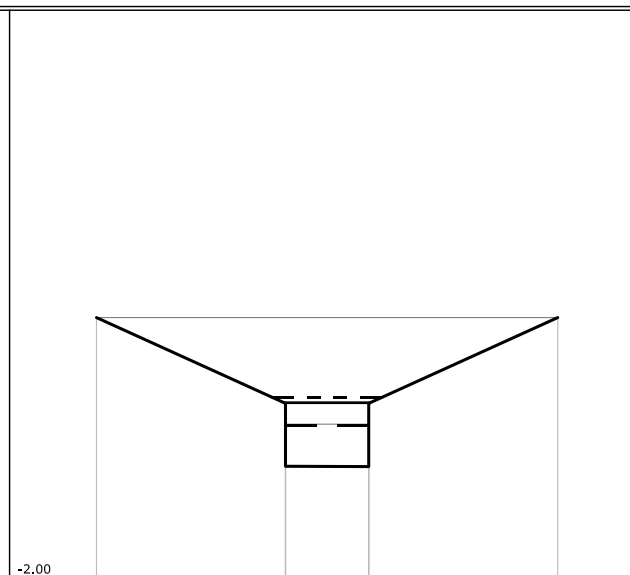

PUNTI	1	2	6	9
QUOTE [m s.l.m.]	4.87	2.60	0.93	4.87
DISTANZE PROGRESSIVE [m]	0.00	5.00	7.20	12.20
DISTANZE PARZIALI [m]		5.00	2.20	5.00

Fosso Carlone 2  
 SEZIONE N° 00023PD08

LEGENDA:

TR30 H = 2.02 m. s.l.m. \_\_\_\_\_

TR200 H = 2.62 m. s.l.m. \_\_\_\_\_

TR500 H = 2.76 m. s.l.m. - - - - -

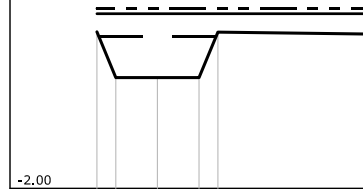

SCALA DISTANZE 1:200  
 SCALA QUOTE 1:200

PUNTI	1	2	3	4	5	6
QUOTE [m s.l.m.]	2.14	0.93	0.93	0.93	2.13	2.08
DISTANZE PROGRESSIVE [m]	0.00	0.50	1.60	2.70	3.20	7.20
DISTANZE PARZIALI [m]		1.10	1.10		4.00	



Fosso Carlone 2  
 SEZIONE N° 00021\_\_08

LEGENDA:

- TR30 H = 2.02 m. s.l.m.
- TR200 H = 2.62 m. s.l.m.
- TR500 H = 2.76 m. s.l.m.

SCALA DISTANZE 1:200  
 SCALA QUOTE 1:200

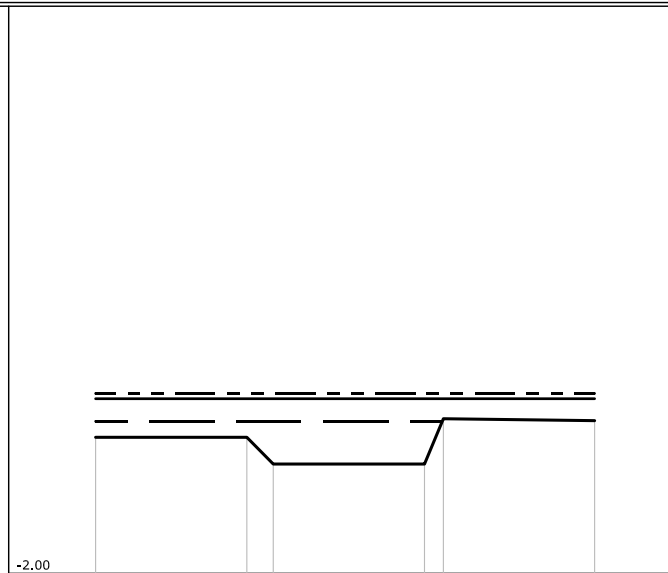

PUNTI	1	2	3	4	5	6
QUOTE [m s.l.m.]	1.60	1.60	0.89	0.89	2.09	2.04
DISTANZE PROGRESSIVE [m]	0.00	4.00	4.70	8.70	9.20	13.20
DISTANZE PARZIALI [m]		4.00		4.00		4.00

Fosso Carlone 2  
 SEZIONE N° 00020PA08

LEGENDA:

TR30 H =2.02 m. s.l.m. ———

TR200 H =2.62 m. s.l.m. ———

TR500 H =2.76 m. s.l.m. - - - - -

SCALA DISTANZE 1:200  
 SCALA QUOTE 1:200

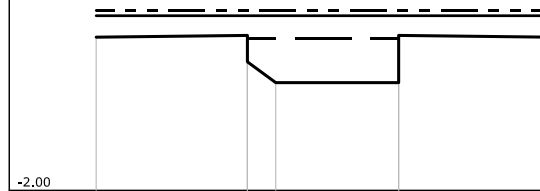

PUNTI	1	2	5	6	8
QUOTE [m s.l.m.]	2.05	2.10	0.85	0.85	2.05
DISTANZE PROGRESSIVE [m]	0.00	4.00	4.75	8.00	12.00
DISTANZE PARZIALI [m]		4.00		3.25	4.00

Fosso Carlone 2  
 SEZIONE N° 00020PB08

LEGENDA:

TR30 H =2.02 m. s.l.m. \_\_\_\_\_

TR200 H =2.62 m. s.l.m. \_\_\_\_\_

TR500 H =2.76 m. s.l.m. - - - - -

SCALA DISTANZE 1:200  
 SCALA QUOTE 1:200

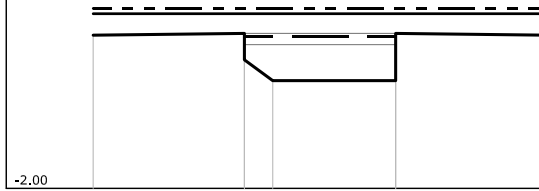

PUNTI	1	2	4	5	7
QUOTE [m s.l.m.]	2.05	2.10	0.85	0.85	2.05
DISTANZE PROGRESSIVE [m]	0.00	4.00	4.75	8.00	12.00
DISTANZE PARZIALI [m]		4.00		3.25	4.00

Fosso Carlone 2  
 SEZIONE N° 00020PC08

LEGENDA:

TR30 H =2.03 m. s.l.m. ———

TR200 H =2.63 m. s.l.m. ———

TR500 H =2.76 m. s.l.m. - - - - -

SCALA DISTANZE 1:200  
 SCALA QUOTE 1:200

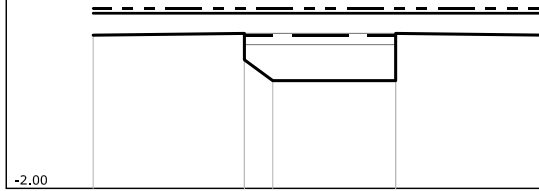

PUNTI	1	2	4	5	7
QUOTE [m s.l.m.]	2.05	2.10	0.85	0.85	2.05
DISTANZE PROGRESSIVE [m]	0.00	4.00	4.75	8.00	12.00
DISTANZE PARZIALI [m]		4.00		3.25	4.00

Fosso Carlone 2  
 SEZIONE N° 00020PD08

LEGENDA:

TR30 H =2.03 m. s.l.m. ———

TR200 H =2.63 m. s.l.m. ———

TR500 H =2.76 m. s.l.m. - - - - -

SCALA DISTANZE 1:200  
 SCALA QUOTE 1:200

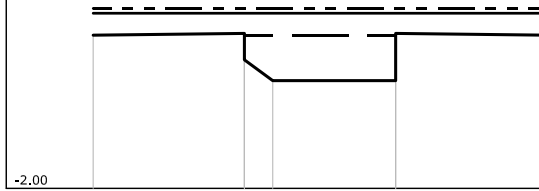

PUNTI	1	2	5	6	8
QUOTE [m s.l.m.]	2.05	2.10	0.85	0.85	2.05
DISTANZE PROGRESSIVE [m]	0.00	4.00	4.75	8.00	12.00
DISTANZE PARZIALI [m]		4.00		3.25	4.00

Fosso Carlone 2  
 SEZIONE N° 00019\_\_08

LEGENDA:

- TR30 H =2.03 m. s.l.m.
- TR200 H =2.64 m. s.l.m.
- TR500 H =2.76 m. s.l.m.

SCALA DISTANZE 1:200  
 SCALA QUOTE 1:200

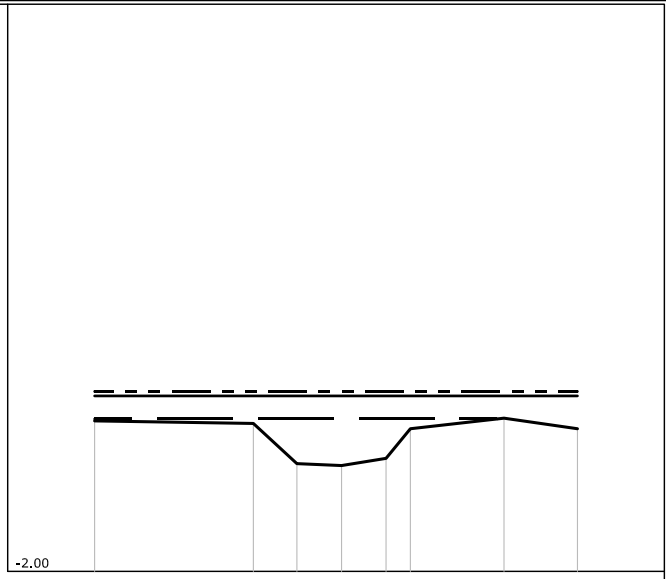

PUNTI	1	2	3	4	5	6	7	8
QUOTE [m s.l.m.]	1.98	1.91	0.85	0.80	0.99	1.77	2.05	1.77
DISTANZE PROGRESSIVE [m]	0.00	4.20	5.35	6.53	7.71	8.35	10.83	12.77
DISTANZE PARZIALI [m]		4.20	1.15	1.18	1.18		2.48	1.94

Fosso Carlone 2  
 SEZIONE N° 00014\_\_08

LEGENDA:

TR30 H =2.03 m. s.l.m. ———

TR200 H =2.63 m. s.l.m. ———

TR500 H =2.76 m. s.l.m. - - - - -

SCALA DISTANZE 1:200  
 SCALA QUOTE 1:200

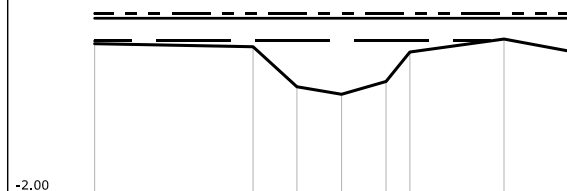



PUNTI	1	2	3	4	5	6	7	8
QUOTE [m s.l.m.]	1.96	1.88	0.82	0.62	0.96	1.74	2.08	1.72
DISTANZE PROGRESSIVE [m]	0.00	4.19	5.35	6.53	7.71	8.34	10.83	12.77
DISTANZE PARZIALI [m]		4.19	1.16	1.18	1.18		2.49	1.94

Fosso Carlone 2  
 SEZIONE N° 00004\_\_08

LEGENDA:

TR30 H =2.03 m. s.l.m. 

TR200 H =2.63 m. s.l.m. 

TR500 H =2.76 m. s.l.m. 

SCALA DISTANZE 1:200  
 SCALA QUOTE 1:200

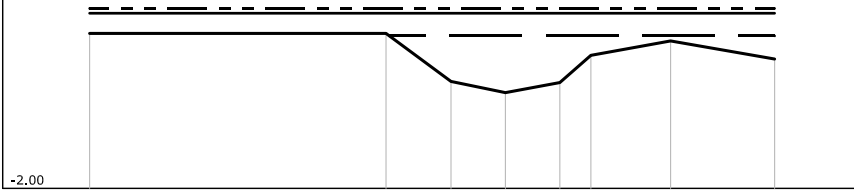

PUNTI	1	2	3	4	5	6	7	8
QUOTE [m s.l.m.]	2.10	2.10	0.83	0.53	0.80	1.52	1.90	1.42
DISTANZE PROGRESSIVE [m]	0.00	7.84	9.56	11.00	12.44	13.26	15.37	18.12
DISTANZE PARZIALI [m]		7.84	1.72	1.44	1.44	2.11	2.75	



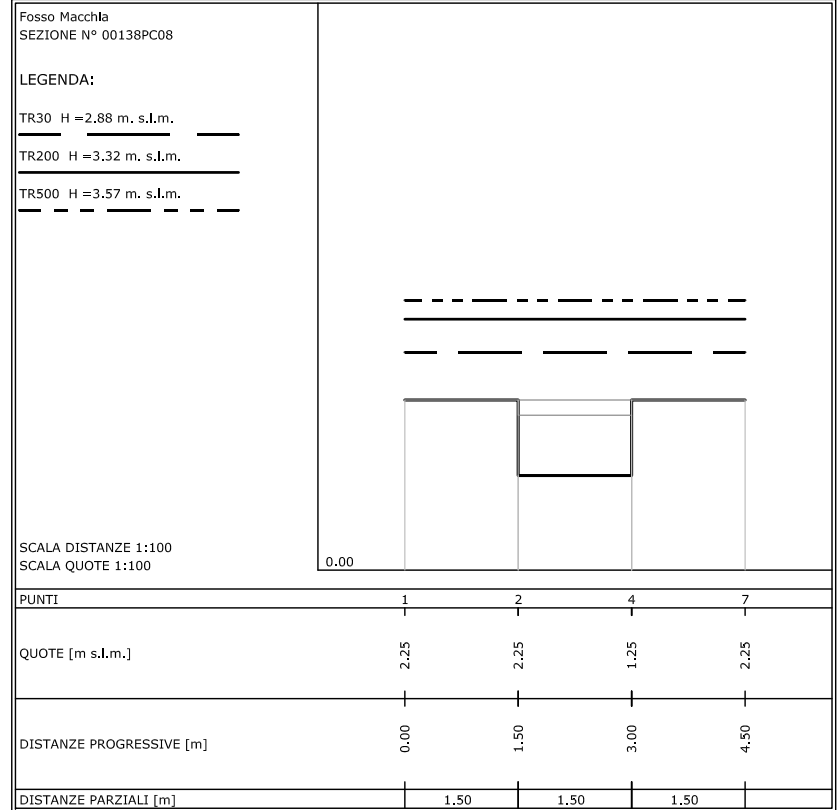

Fosso Macchia



Fosso Macchia  
 SEZIONE N° 00138PD08

LEGENDA:

TR30 H = 2.85 m. s.l.m. 

TR200 H = 3.30 m. s.l.m. 

TR500 H = 3.44 m. s.l.m. 

SCALA DISTANZE 1:100  
 SCALA QUOTE 1:100

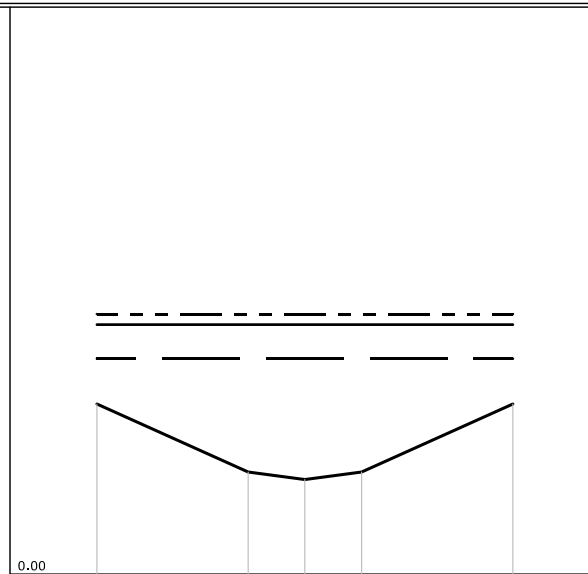



PUNTI	1	2	3	4	5
QUOTE [m s.l.m.]	2.25	1.35	1.25	1.35	2.25
DISTANZE PROGRESSIVE [m]	0.00	2.00	2.75	3.50	5.50
DISTANZE PARZIALI [m]		2.00	0.75	0.75	2.00

Fosso Macchia  
SEZIONE N° 00120PA03

LEGENDA:

TR30 H = 3.37 m. s.l.m. 

TR200 H = 3.99 m. s.l.m. 

TR500 H = 4.19 m. s.l.m. 

SCALA DISTANZE 1:100  
SCALA QUOTE 1:100

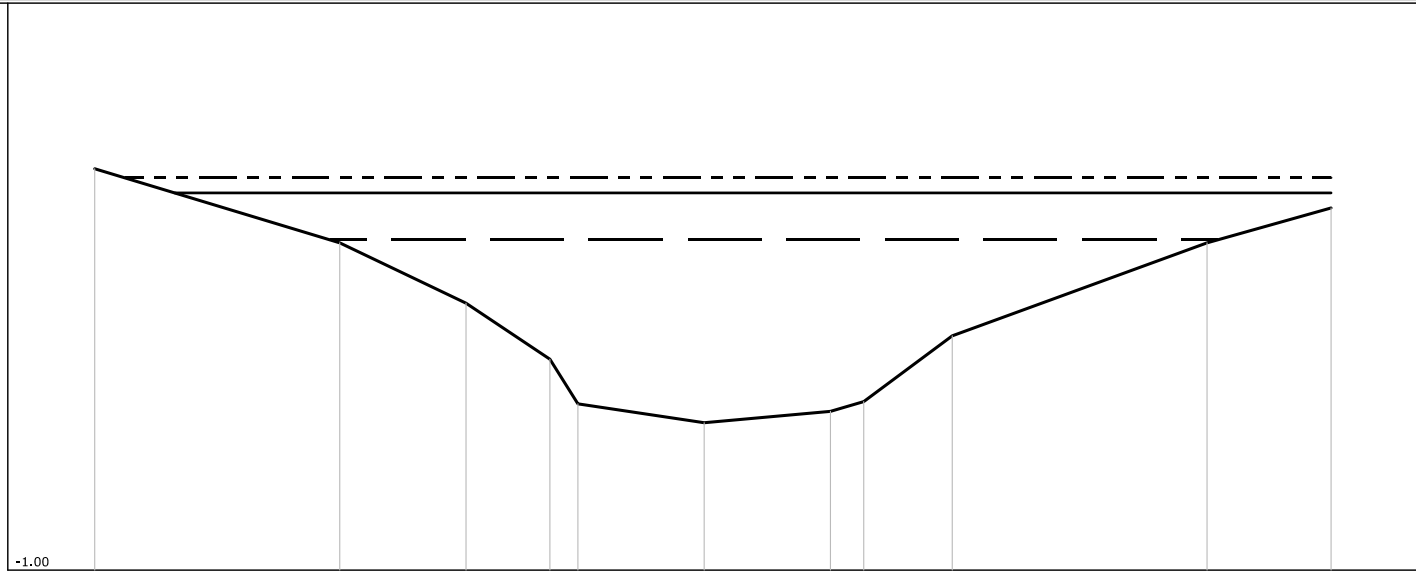



PUNTI	1	2	3	4	5	6	7	8	9	10	11
QUOTE [m s.l.m.]	4.31	3.33	2.53	1.79	1.20	0.95	1.10	1.23	2.10	3.33	3.79
DISTANZE PROGRESSIVE [m]	0.00	3.24	4.91	6.02	6.39	8.06	9.73	10.17	11.34	14.71	16.35
DISTANZE PARZIALI [m]		3.24	1.67	1.11	1.67	1.67	1.17	3.37	1.64		

Fosso Macchia  
SEZIONE N° 00120PB03

LEGENDA:

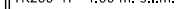
TR30 H = 3.37 m. s.l.m. 

TR200 H = 4.00 m. s.l.m. 

TR500 H = 4.20 m. s.l.m. 

SCALA DISTANZE 1:100  
SCALA QUOTE 1:100

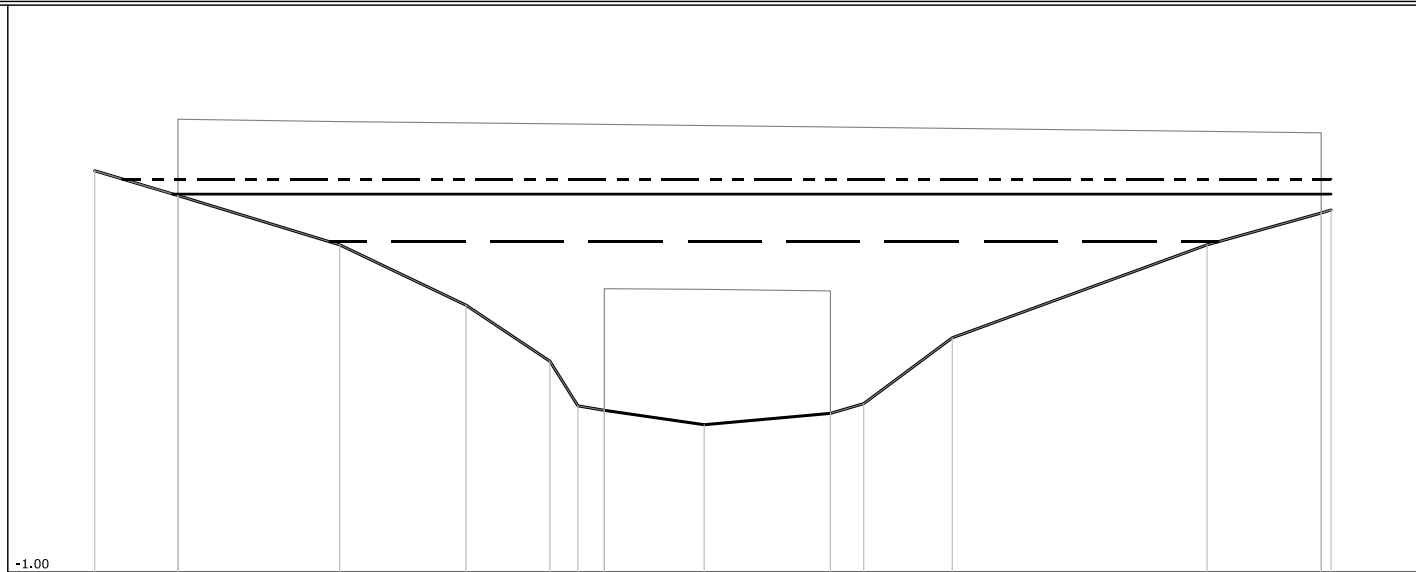

PUNTI	1	2	4	5	6	7	8	10	11	13	14	15	16	18
QUOTE [m s.l.m.]	4.31	3.98	3.33	2.53	1.79	1.20	1.14	0.95	1.10	1.23	2.10	3.33	3.75	3.75
DISTANZE PROGRESSIVE [m]	0.00	1.10	3.24	4.91	6.02	6.39	6.74	8.06	9.73	10.17	11.34	14.71	16.33	16.33
DISTANZE PARZIALI [m]		1.10	2.14	1.67	1.11			1.32	1.67		1.17	3.37	1.51	

Fosso Macchia  
SEZIONE N° 00120PC03

LEGENDA:

- TR30 H = 2,73 m. s.l.m.
- TR200 H = 3,32 m. s.l.m.
- TR500 H = 3,43 m. s.l.m.

SCALA DISTANZE 1:100  
SCALA QUOTE 1:100

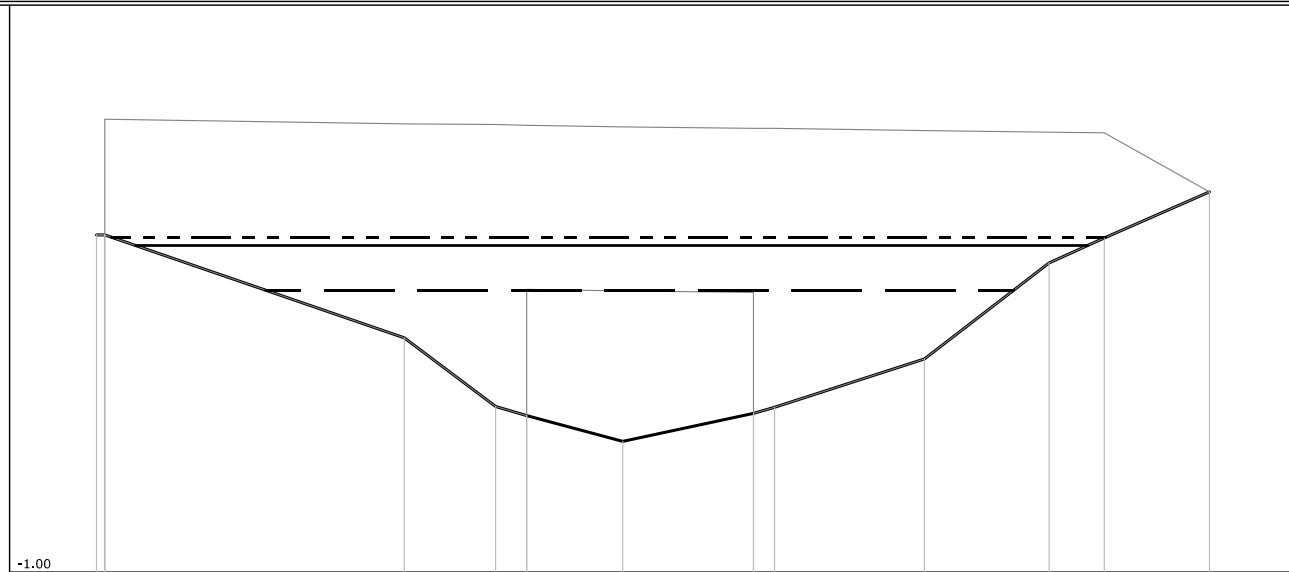

PUNTI	1	5	6	7	9	10	12	13	14	15	16
QUOTE [m s.l.m.]	3.46	2.10	1.19	1.07	0.73	1.10	1.18	1.82	3.09	3.42	4.03
DISTANZE PROGRESSIVE [m]	0.00	4.07	5.28	5.69	6.96	8.69	8.97	10.95	12.60	13.33	14.72
DISTANZE PARZIALI [m]		3.96	1.21		1.27	1.73		1.98	1.65	0.73	1.39

Fosso Macchia  
SEZIONE N° 00120PD03

LEGENDA:

TR30 H = 2.73 m. s.l.m. \_\_\_\_\_

TR200 H = 3.32 m. s.l.m. \_\_\_\_\_

TR500 H = 3.43 m. s.l.m. \_\_\_\_\_

SCALA DISTANZE 1:100  
SCALA QUOTE 1:100

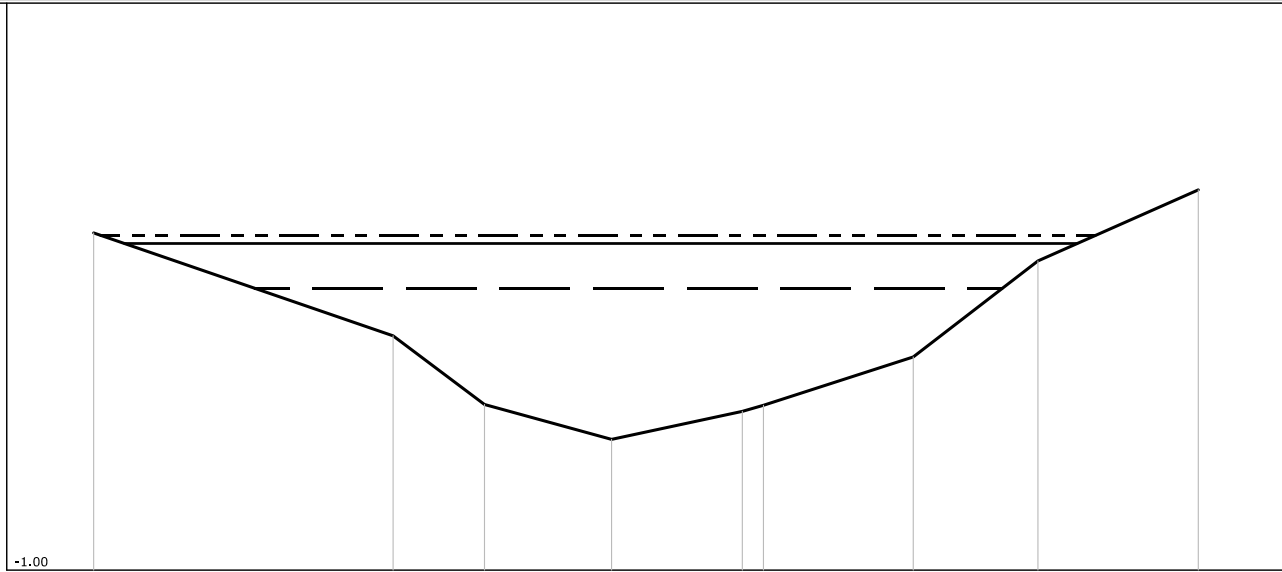

PUNTI	1	2	3	4	5	6	7	8	9
QUOTE [m s.l.m.]	3.46	2.10	1.19	0.73	1.10	1.18	1.82	3.09	4.03
DISTANZE PROGRESSIVE [m]	0.00	3.96	5.17	6.85	8.58	8.86	10.84	12.49	14.61
DISTANZE PARZIALI [m]		3.96	1.21	1.68	1.73		1.98	1.65	2.12

Fosso Macchla  
SEZIONE N° 00112PA03

LEGENDA:

TR30 H =2.71 m. s.l.m. \_\_\_\_\_

TR200 H =3.01 m. s.l.m. \_\_\_\_\_

TR500 H =3.13 m. s.l.m. - - - - -

SCALA DISTANZE 1:100  
SCALA QUOTE 1:100

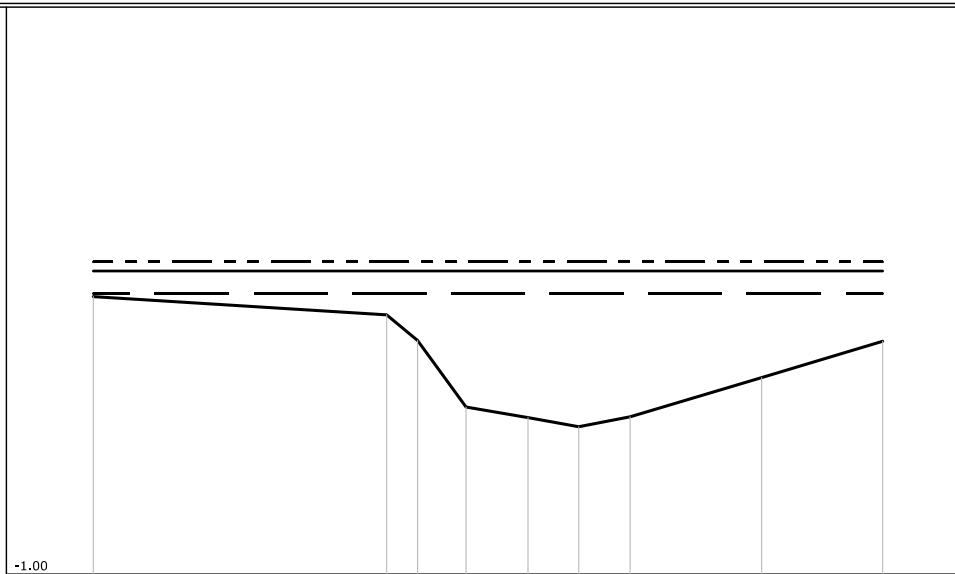

PUNTI	1	2	3	4	5	6	7	8	9
QUOTE [m s.l.m.]	2.67	2.43	2.09	1.21	1.07	0.95	1.08	1.60	2.08
DISTANZE PROGRESSIVE [m]	0.00	3.88	4.29	4.93	5.75	6.42	7.10	8.84	10.44
DISTANZE PARZIALI [m]		3.88	0.64	0.82	0.67	0.68	1.74	1.60	



Fosso Macchia  
SEZIONE N° 00112PB03

LEGENDA:

TR30 H =2.72 m. s.l.m. ———

TR200 H =3.01 m. s.l.m. ———

TR500 H =3.13 m. s.l.m. - - - - -

SCALA DISTANZE 1:100  
SCALA QUOTE 1:100

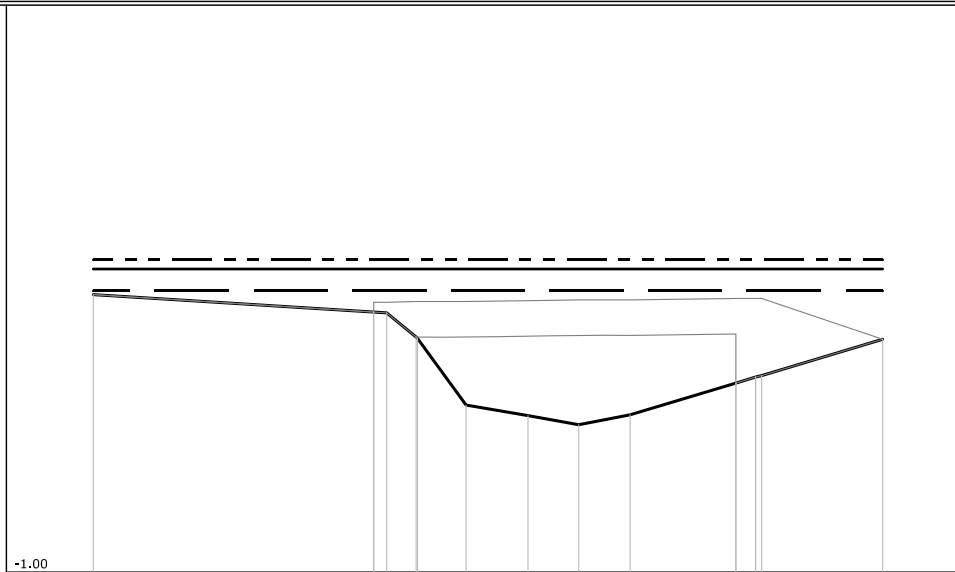

PUNTI	1	2	4	5	7	8	9	10	11	13	16
QUOTE [m s.l.m.]	2.67	2.44	2.43	2.11	1.21	1.07	0.95	1.08	1.50	1.58	2.08
DISTANZE PROGRESSIVE [m]	0.00	3.71	3.88	4.27	4.93	5.75	6.42	7.10	8.50	8.76	10.44
DISTANZE PARZIALI [m]		3.71		0.64	0.82	0.67	0.68	1.40		1.60	

Fosso Macchla  
SEZIONE N° 00112PC03

LEGENDA:

TR30 H =2.67 m. s.l.m. ———

TR200 H =2.97 m. s.l.m. ———

TR500 H =3.09 m. s.l.m. - - - - -

SCALA DISTANZE 1:100  
SCALA QUOTE 1:100

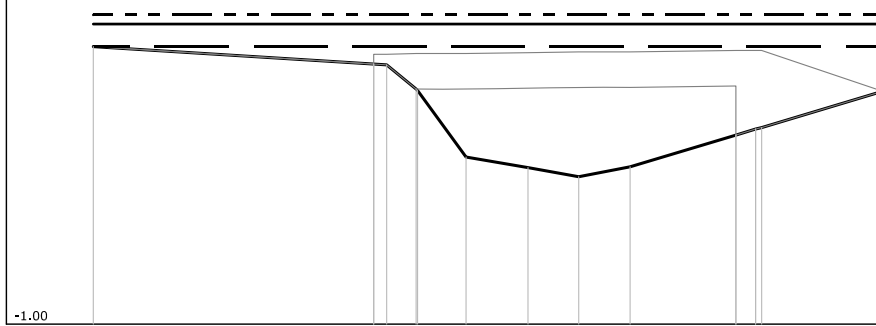

PUNTI	1	2	4	5	7	8	9	10	11	13	16
QUOTE [m s.l.m.]	2.67	2.44	2.43	2.11	1.21	1.07	0.95	1.08	1.50	1.58	2.08
DISTANZE PROGRESSIVE [m]	0.00	3.71	3.88	4.27	4.93	5.75	6.42	7.10	8.50	8.76	10.44
DISTANZE PARZIALI [m]		3.71		0.64	0.82	0.67	0.68	1.40		1.60	

Fosso Macchia  
SEZIONE N° 00112PD03

LEGENDA:

TR30 H =2.67 m. s.l.m. 

TR200 H =2.97 m. s.l.m. 

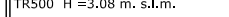
TR500 H =3.08 m. s.l.m. 

SCALA DISTANZE 1:100  
SCALA QUOTE 1:100

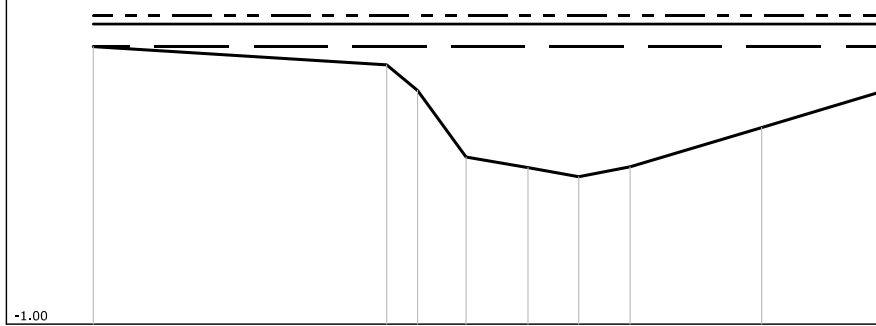



PUNTI	1	2	3	4	5	6	7	8	9
QUOTE [m s.l.m.]	2.67	2.43	2.09	1.21	1.07	0.95	1.08	1.60	2.08
DISTANZE PROGRESSIVE [m]	0.00	3.88	4.29	4.93	5.75	6.42	7.10	8.84	10.44
DISTANZE PARZIALI [m]		3.88	0.64	0.82	0.67	0.68	1.74	1.60	

Fosso Macchia  
 SEZIONE N° 00106\_\_03

LEGENDA:

TR30 H =2.53 m. s.l.m. 

TR200 H =2.89 m. s.l.m. 

TR500 H =3.02 m. s.l.m. 

SCALA DISTANZE 1:100  
 SCALA QUOTE 1:100

-1.00

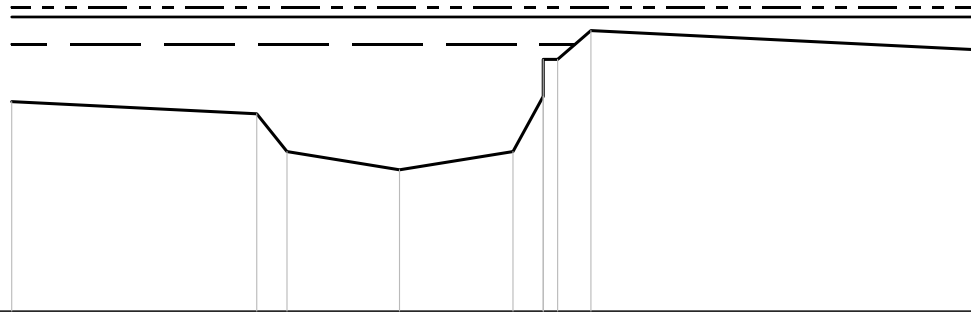

PUNTI	1	2	3	4	5	6	8	9	10
QUOTE [m s.l.m.]	1.77	1.61	1.11	0.87	1.11	1.84	2.33	2.71	2.46
DISTANZE PROGRESSIVE [m]	0.00	3.24	3.64	5.13	6.63	7.03	7.22	7.66	12.73
DISTANZE PARZIALI [m]		3.24		1.49	1.50				5.07

Fosso Macchia  
 SEZIONE N° 00097PA03

LEGENDA:

TR30 H =2.42 m. s.l.m. ————

TR200 H =2.83 m. s.l.m. ————

TR500 H =2.95 m. s.l.m. - - - - -

SCALA DISTANZE 1:100  
 SCALA QUOTE 1:100

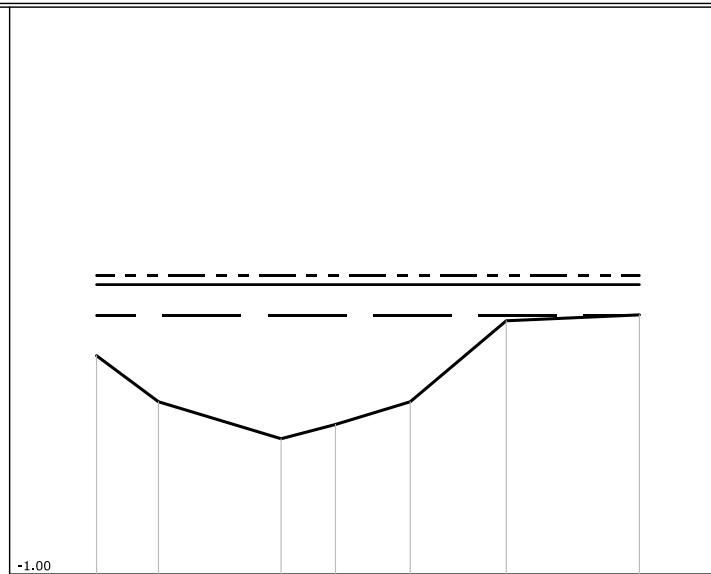

PUNTI	1	2	3	4	5	6	7
QUOTE [m s.l.m.]	1.89	1.28	0.79	0.98	1.28	2.35	2.43
DISTANZE PROGRESSIVE [m]	0.00	0.82	2.44	3.16	4.15	5.42	7.18
DISTANZE PARZIALI [m]		0.82	1.62	0.72	0.99	1.27	1.76

Fosso Macchia  
 SEZIONE N° 00097PB03

LEGENDA:

TR30 H =2.42 m. s.l.m. ———

TR200 H =2.83 m. s.l.m. ———

TR500 H =2.95 m. s.l.m. - - - - -

SCALA DISTANZE 1:100  
 SCALA QUOTE 1:100

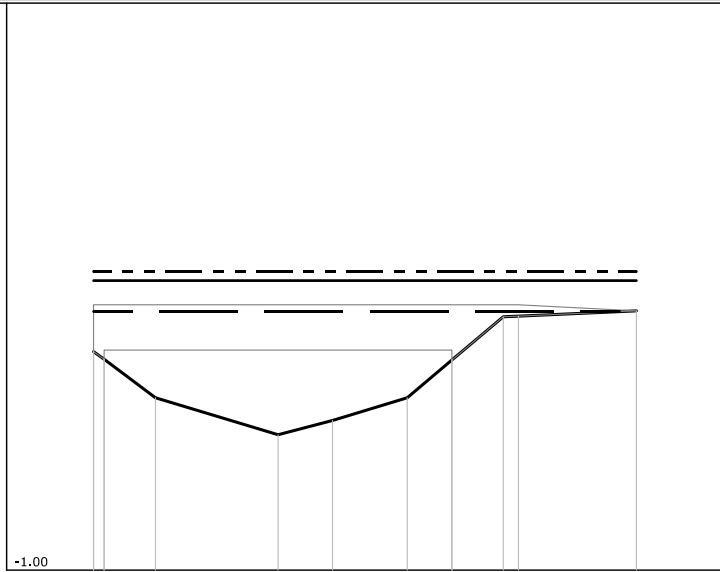

PUNTI	13	5	6	7	8	9	1112	13
QUOTE [m s.l.m.]	1.89 1.79	1.28	0.79	0.98	1.28	1.78	2.35 2.36	2.43
DISTANZE PROGRESSIVE [m]	0.00 0.14	0.82	2.44	3.16	4.15	4.74	5.42 5.82	7.18
DISTANZE PARZIALI [m]		0.68	1.62	0.72	0.99	0.59	0.68	1.56

Fosso Macchia  
 SEZIONE N° 00097PC03

LEGENDA:

TR30 H =2.34 m. s.l.m. ————

TR200 H =2.79 m. s.l.m. ————

TR500 H =2.92 m. s.l.m. - - - - -

SCALA DISTANZE 1:100  
 SCALA QUOTE 1:100

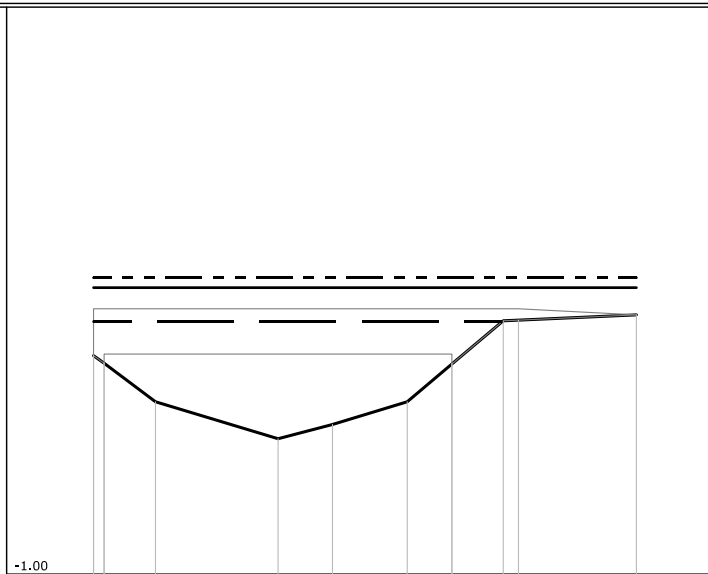

PUNTI	13	5	6	7	8	9	1112	13
QUOTE [m s.l.m.]	1.89 1.79	1.28	0.79	0.98	1.28	1.78	2.35 2.36	2.43
DISTANZE PROGRESSIVE [m]	0.00 0.14	0.82	2.44	3.16	4.15	4.74	5.42 5.82	7.18
DISTANZE PARZIALI [m]		0.68	1.62	0.72	0.99	0.59	0.68	1.56

Fosso Macchia  
 SEZIONE N° 00097PD03

LEGENDA:

TR30 H = 2.34 m. s.l.m. ———

TR200 H = 2.79 m. s.l.m. ———

TR500 H = 2.92 m. s.l.m. - - - - -

SCALA DISTANZE 1:100  
 SCALA QUOTE 1:100

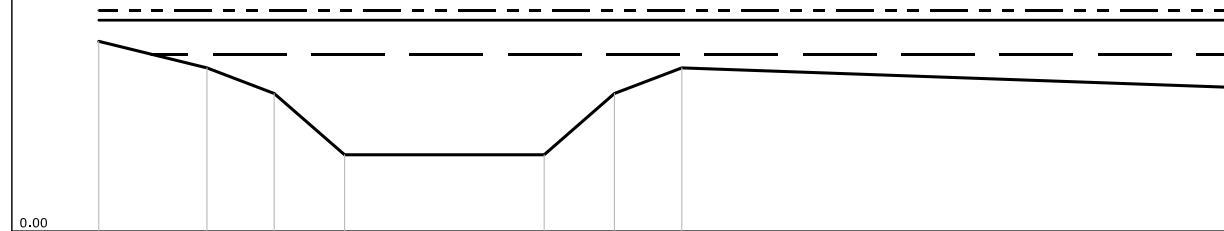

PUNTI	1	2	3	4	5	6	7	8
QUOTE [m s.l.m.]	2.51	2.16	1.82	1.01	1.01	1.82	2.16	1.90
DISTANZE PROGRESSIVE [m]	0.00	1.43	2.32	3.25	5.89	6.82	7.71	15.00
DISTANZE PARZIALI [m]		1.43	0.89	0.93	2.64	0.93	0.89	7.29



Fosso Macchia  
SEZIONE N° 00083\_\_03

LEGENDA:

TR30 H =2.30 m. s.l.m. \_\_\_\_\_

TR200 H =2.77 m. s.l.m. \_\_\_\_\_

TR500 H =2.91 m. s.l.m. - - - - -

SCALA DISTANZE 1:100  
SCALA QUOTE 1:100

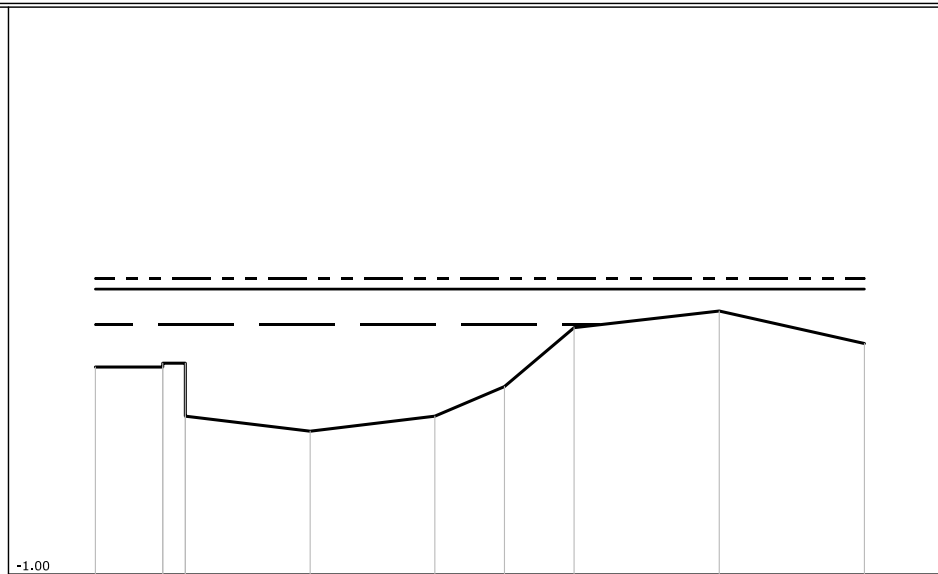

PUNTI	1	2	4	6	7	8	9	10	11
QUOTE [m s.l.m.]	1.74	1.74	1.79	0.89	1.09	1.48	2.26	2.48	2.05
DISTANZE PROGRESSIVE [m]	0.00	0.89	1.19	2.84	4.49	5.41	6.33	8.25	10.17
DISTANZE PARZIALI [m]		0.89		1.65	1.65	0.92	0.92	1.92	1.92

Fosso Macchia  
 SEZIONE N° 00066\_\_03

LEGENDA:

TR30 H = 2.27 m. s.l.m. \_\_\_\_\_

TR200 H = 2.73 m. s.l.m. \_\_\_\_\_

TR500 H = 2.87 m. s.l.m. \_\_\_\_\_

SCALA DISTANZE 1:100  
 SCALA QUOTE 1:100

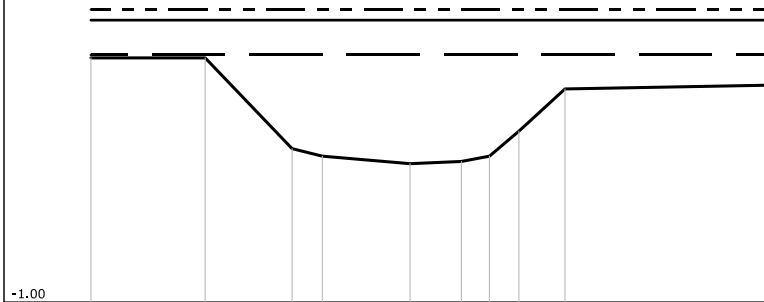



PUNTI	1	2	3	4	5	6	7	8	9	10
QUOTE [m s.l.m.]	2.23	2.23	1.03	0.93	0.83	0.86	0.93	1.26	1.82	1.87
DISTANZE PROGRESSIVE [m]	0.00	1.51	2.66	3.06	4.22	4.90	5.27	5.66	6.27	9.02
DISTANZE PARZIALI [m]		1.51	1.15		1.16	0.68			0.61	2.75

Fosso Macchia  
 SEZIONE N° 00013\_\_08

LEGENDA:

TR30 H = 2.21 m. s.l.m. 

TR200 H = 2.70 m. s.l.m. 

TR500 H = 2.84 m. s.l.m. 

SCALA DISTANZE 1:100  
 SCALA QUOTE 1:100

-1.00

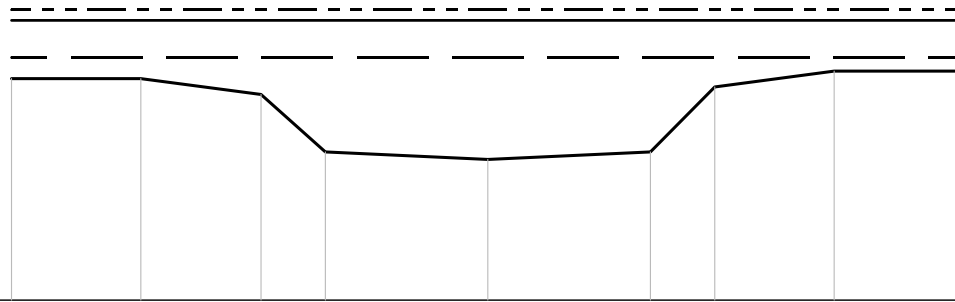

PUNTI	1	2	3	4	5	6	7	8	9
QUOTE [m s.l.m.]	1.93	1.93	1.72	0.96	0.86	0.96	1.82	2.03	2.03
DISTANZE PROGRESSIVE [m]	0.00	1.71	3.30	4.15	6.30	8.45	9.30	10.88	12.60
DISTANZE PARZIALI [m]		1.71	1.59	0.85	2.15	2.15	0.85	1.58	1.72

Fosso Macchia  
 SEZIONE N° 00007\_\_08

LEGENDA:

- TR30 H = 2.18 m. s.l.m.
- TR200 H = 2.69 m. s.l.m.
- TR500 H = 2.83 m. s.l.m.

SCALA DISTANZE 1:100  
 SCALA QUOTE 1:100

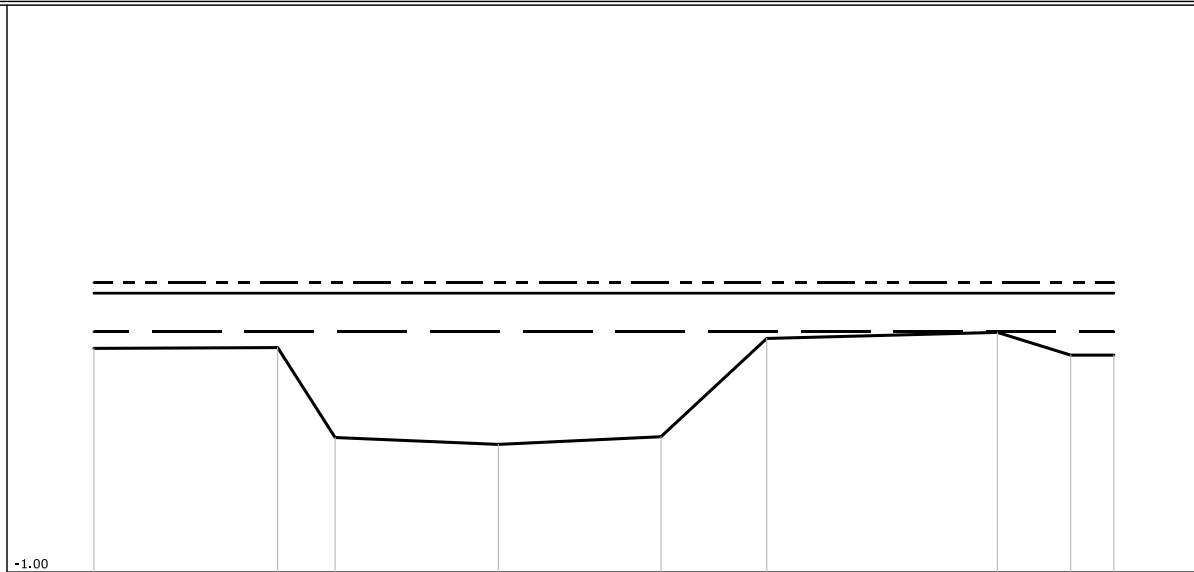

PUNTI	1	2	3	4	5	6	7	8	9
QUOTE [m s.l.m.]	1.96	1.97	0.78	0.69	0.79	2.09	2.17	1.87	1.87
DISTANZE PROGRESSIVE [m]	0.00	2.43	3.19	5.35	7.50	8.90	11.95	12.92	13.49
DISTANZE PARZIALI [m]		2.43	0.76	2.16	2.15	1.40	3.05	0.97	0.57

Fosso Macchia  
 SEZIONE N° 00002\_\_08

LEGENDA:

TR30 H =2.15 m. s.l.m. 

TR200 H =2.68 m. s.l.m. 

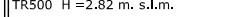
TR500 H =2.82 m. s.l.m. 

SCALA DISTANZE 1:100  
 SCALA QUOTE 1:100

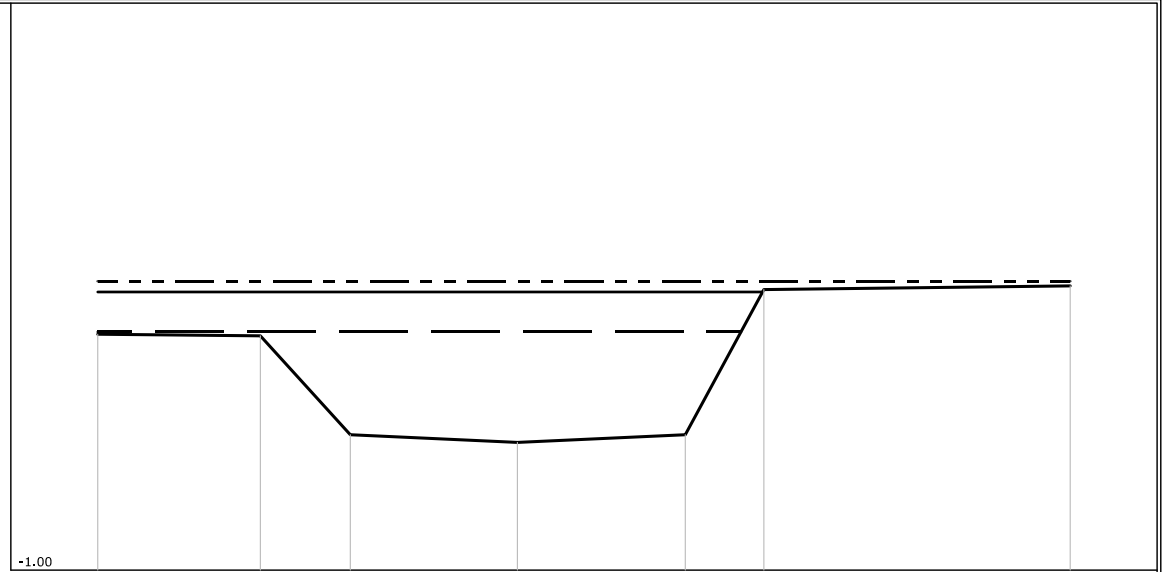

PUNTI	1	2	3	4	5	6	7
QUOTE [m s.l.m.]	2.12	2.10	0.79	0.69	0.79	2.71	2.76
DISTANZE PROGRESSIVE [m]	0.00	2.15	3.34	5.55	7.77	8.81	12.86
DISTANZE PARZIALI [m]		2.15	1.19	2.21	2.22	1.04	4.05

Fosso dei Due Canali

Fosso del Due Canali  
 SEZIONE N° 00137\_\_06

LEGENDA:

TR30 H = 2.98 m. s.l.m. ———

TR200 H = 3.18 m. s.l.m. ———

TR500 H = 3.27 m. s.l.m. - - - - -

SCALA DISTANZE 1:100  
 SCALA QUOTE 1:100

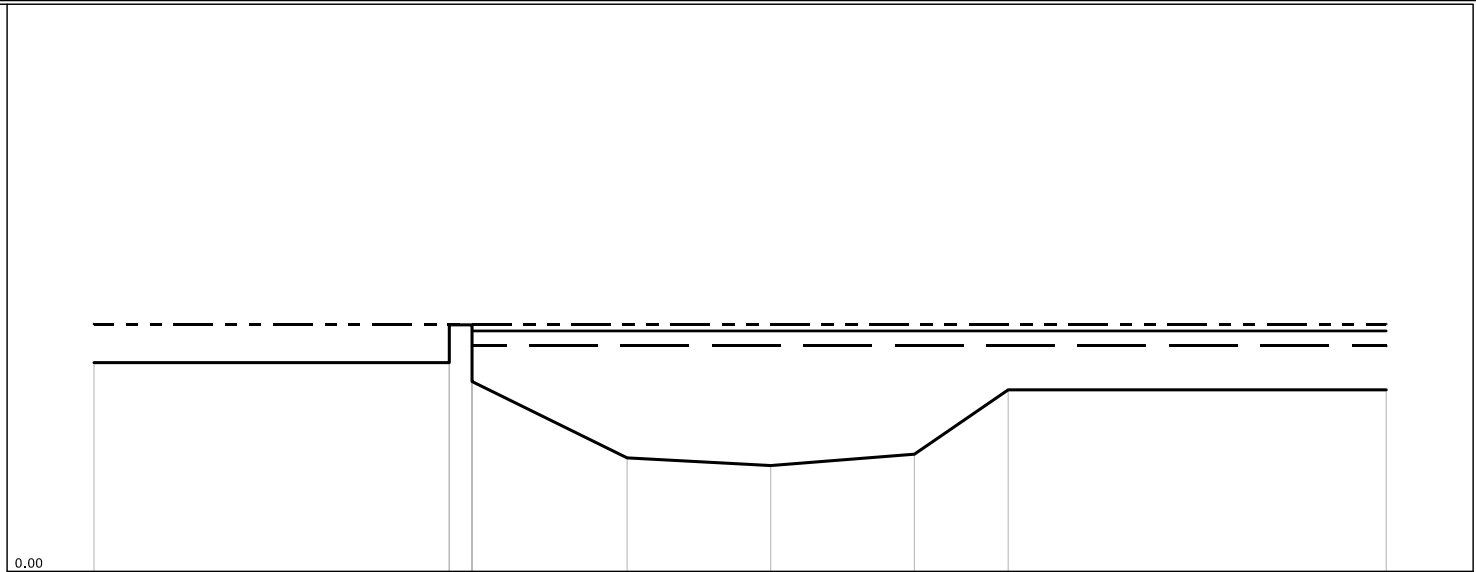

PUNTI	1	2	4	6	7	8	9	10
QUOTE [m s.l.m.]	2.76	2.76	3.26	1.50	1.40	1.55	2.40	2.40
DISTANZE PROGRESSIVE [m]	0.00	4.70	5.00	7.05	8.95	10.85	12.09	17.09
DISTANZE PARZIALI [m]		4.70		2.05	1.90	1.90	1.24	5.00

Fosso del Due Canali  
 SEZIONE N° 00131\_\_06

LEGENDA:

TR30 H = 2.97 m. s.l.m. ————

TR200 H = 3.15 m. s.l.m. ————

TR500 H = 3.24 m. s.l.m. - - - - -

SCALA DISTANZE 1:100  
 SCALA QUOTE 1:100

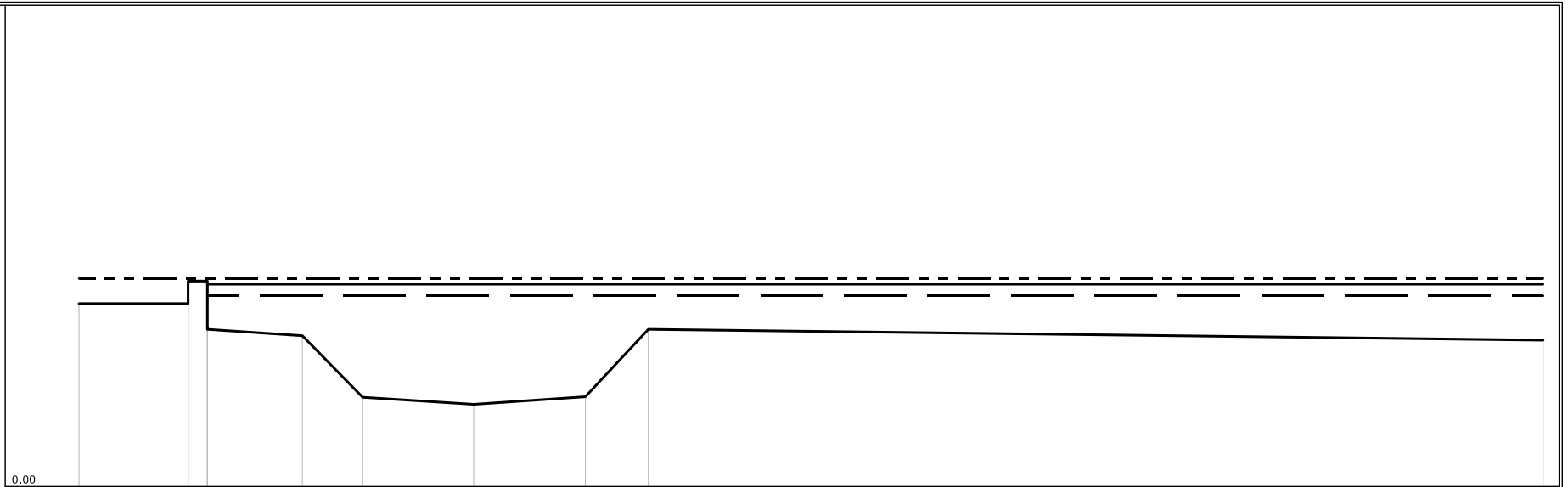

PUNTI	1	2	4	6	7	8	9	10	11
QUOTE [m s.l.m.]	2.85	2.85	3.20	2.35	1.39	1.28	1.40	2.45	2.28
DISTANZE PROGRESSIVE [m]	0.00	1.70	2.00	3.48	4.42	6.15	7.89	8.87	22.81
DISTANZE PARZIALI [m]		1.70		1.48	0.94	1.73	1.74	0.98	13.94



Fosso del Due Canali  
 SEZIONE N° 00129PA06

LEGENDA:

TR30 H =2.98 m. s.l.m. ————

TR200 H =3.16 m. s.l.m. ————

TR500 H =3.25 m. s.l.m. - - - - -

SCALA DISTANZE 1:100  
 SCALA QUOTE 1:100

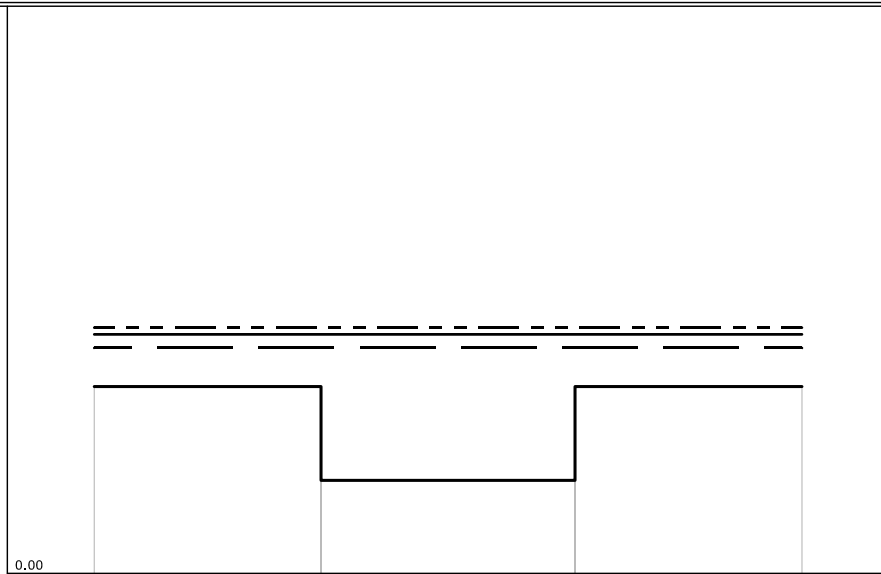

PUNTI	1	2	4	6
QUOTE [m s.l.m.]	2.47	2.47	1.23	2.47
DISTANZE PROGRESSIVE [m]	0.00	3.00	6.36	9.36
DISTANZE PARZIALI [m]		3.00	3.36	3.00

Fosso del Due Canali  
SEZIONE N° 00129PB06

LEGENDA:

TR30 H =2.98 m. s.l.m.

TR200 H =3.17 m. s.l.m.

TR500 H =3.26 m. s.l.m.

SCALA DISTANZE 1:100  
SCALA QUOTE 1:100

-1.00

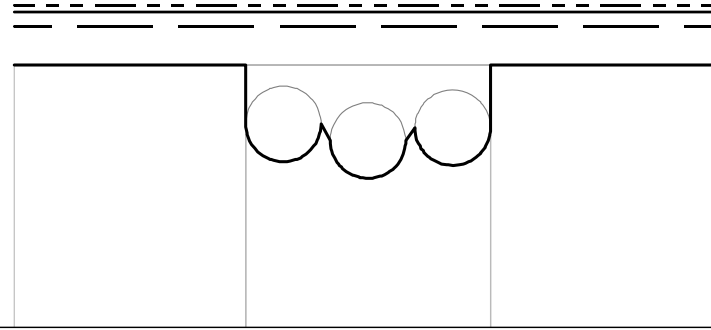



PUNTI	1	2 1 1 1 6 2 9 9 3 9 5 1 5 6 6 3 7 2 8 6 6 0 0 0 3 1 2 7	127
QUOTE [m s.l.m.]	2.47	2.47 1.23 1.20 1.15 1.14 1.14 1.09 1.02 1.13 1.15 1.14 1.14 1.13	2.47
DISTANZE PROGRESSIVE [m]	0.00	0.6 1.7 2.5 3.5 4.4 4.7 4.8 5.1 5.6 6.0 6.3 6.6	9.36
DISTANZE PARZIALI [m]	3.06		3.06

Fosso del Due Canali  
 SEZIONE N° 00129PC06

LEGENDA:

TR30 H =2.95 m. s.l.m. 

TR200 H =3.13 m. s.l.m. 

TR500 H =3.22 m. s.l.m. 

SCALA DISTANZE 1:100  
 SCALA QUOTE 1:100

-1.00

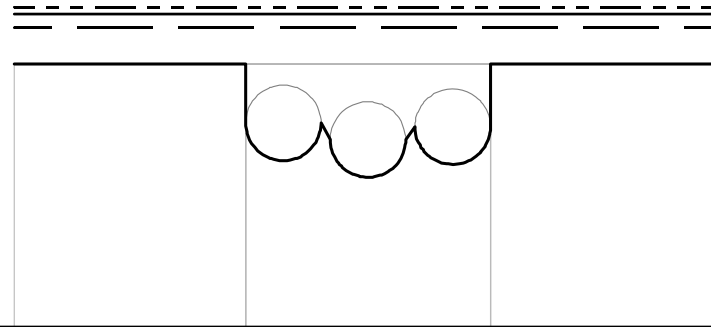



PUNTI	1	2 111 6 0 2 9 9 3 9 3 1 5 6 6 3 7 2 8 6 6 0 0 0 3 1 2 7	127
QUOTE [m s.l.m.]	2.47	2.47 1.73 1.70 1.35 1.34 1.14 1.09 1.02 1.13 1.15 1.14 1.14 1.13	2.47
DISTANZE PROGRESSIVE [m]	0.00	0.6 1.7 2.4 3.1 3.2 3.3 3.4 3.5 3.6 3.7 3.8 3.9 4.0 4.1 4.2 4.3 4.4 4.5 4.6 4.7 4.8 4.9 5.0 5.1 5.2 5.3 5.4 5.5 5.6 5.7 5.8 5.9 6.0 6.1 6.2 6.3 6.4 6.5 6.6 6.7 6.8 6.9 7.0 7.1 7.2 7.3 7.4 7.5 7.6 7.7 7.8 7.9 8.0 8.1 8.2 8.3 8.4 8.5 8.6 8.7 8.8 8.9 9.0 9.1 9.2 9.3 9.4 9.5 9.6 9.7 9.8 9.9 10.0 10.1 10.2 10.3 10.4 10.5 10.6 10.7 10.8 10.9 11.0 11.1 11.2 11.3 11.4 11.5 11.6 11.7 11.8 11.9 12.0 12.1 12.2 12.3 12.4 12.5 12.6 12.7	9.36
DISTANZE PARZIALI [m]	3.06		3.06

Fosso del Due Canali  
 SEZIONE N° 00129PD06

LEGENDA:

TR30 H =2.95 m. s.l.m. 

TR200 H =3.13 m. s.l.m. 

TR500 H =3.22 m. s.l.m. 

SCALA DISTANZE 1:100  
 SCALA QUOTE 1:100

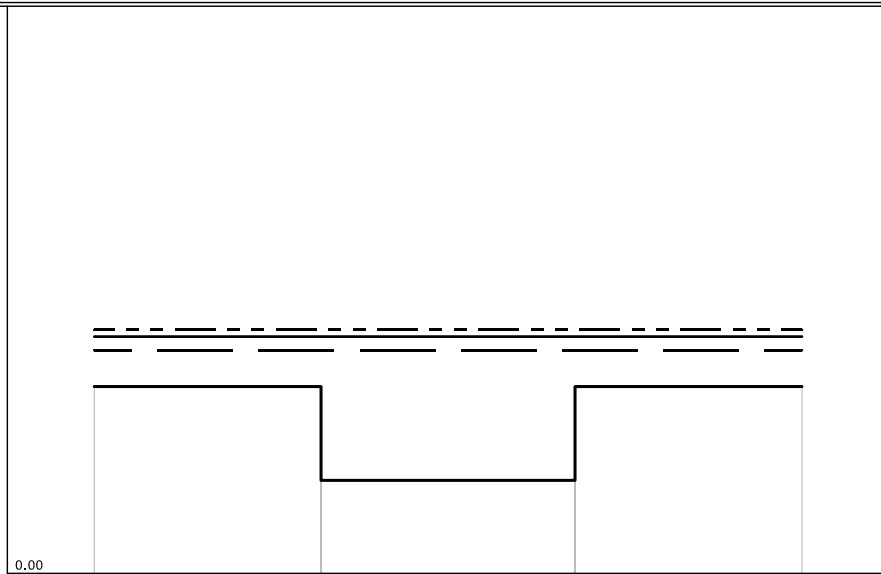

PUNTI	1	2	4	6
QUOTE [m s.l.m.]	2.47	2.47	1.23	2.47
DISTANZE PROGRESSIVE [m]	0.00	3.00	6.36	9.36
DISTANZE PARZIALI [m]		3.00	3.36	3.00

Fosso del Due Canali  
 SEZIONE N° 00128\_\_06

LEGENDA:

TR30 H =2.95 m. s.l.m. ————

TR200 H =3.13 m. s.l.m. —————

TR500 H =3.22 m. s.l.m. - - - - -

SCALA DISTANZE 1:100  
 SCALA QUOTE 1:100

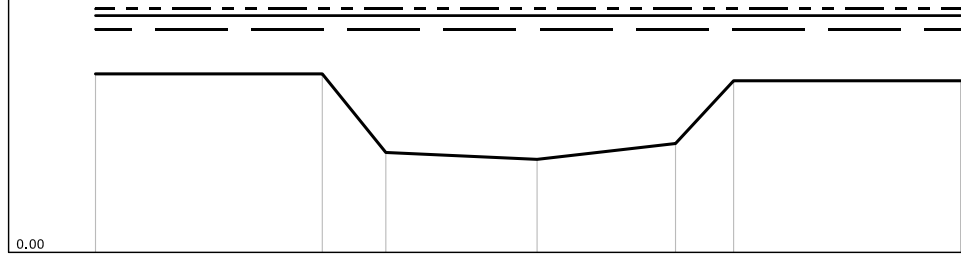

PUNTI	1	2	3	4	5	6	7
QUOTE [m s.l.m.]	2.36	2.36	1.32	1.23	1.44	2.27	2.27
DISTANZE PROGRESSIVE [m]	0.00	3.00	3.84	5.84	7.67	8.44	11.44
DISTANZE PARZIALI [m]		3.00	0.84	2.00	1.83	0.77	3.00

Fosso del Due Canali  
 SEZIONE N° 00125PA06

LEGENDA:

- TR30 H =2.95 m. s.l.m.
- TR200 H =3.14 m. s.l.m.
- TR500 H =3.23 m. s.l.m.

SCALA DISTANZE 1:100  
 SCALA QUOTE 1:100

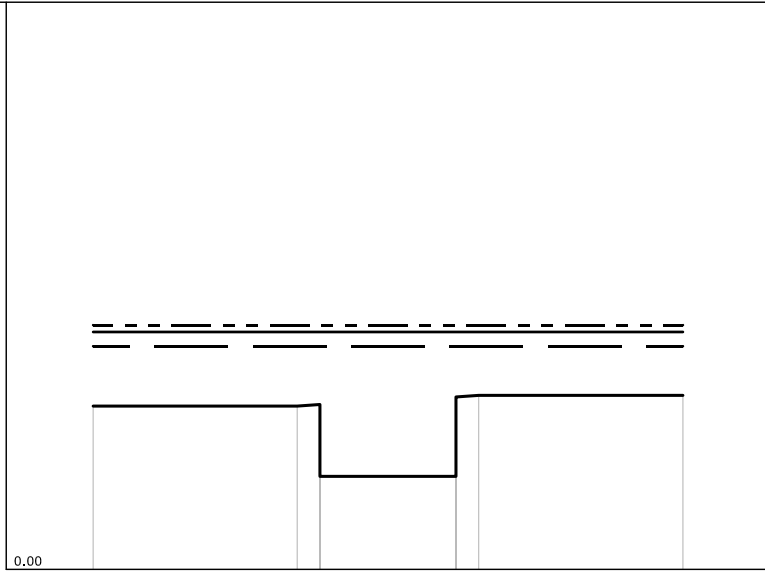

PUNTI	1	2	3	5	7	8
QUOTE [m s.l.m.]	2.16	2.16	2.18	1.23	2.30	2.30
DISTANZE PROGRESSIVE [m]	0.00	2.70	3.00	4.80	5.10	7.80
DISTANZE PARZIALI [m]		2.70		1.80		2.70

Fosso del Due Canali  
 SEZIONE N° 00125PB06

LEGENDA:

- TR30 H =2.95 m. s.l.m.
- TR200 H =3.14 m. s.l.m.
- TR500 H =3.23 m. s.l.m.

SCALA DISTANZE 1:100  
 SCALA QUOTE 1:100

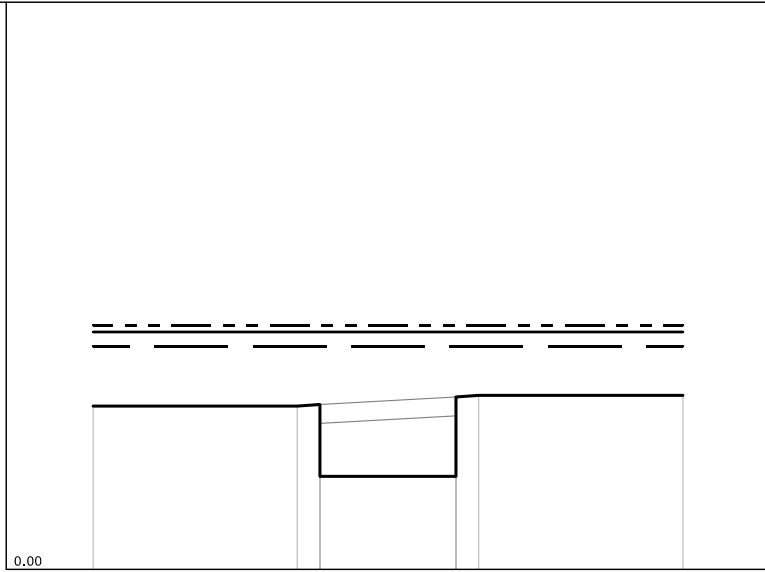

PUNTI	1		2	3		6	9		10
QUOTE [m s.l.m.]	2.16		2.16	2.18		1.23	2.30		2.30
DISTANZE PROGRESSIVE [m]	0.00		2.70	3.00		4.80	5.10		7.80
DISTANZE PARZIALI [m]		2.70			1.80			2.70	

Fosso del Due Canali  
 SEZIONE N° 00125PC06

LEGENDA:

- TR30 H =2.94 m. s.l.m.
- TR200 H =3.13 m. s.l.m.
- TR500 H =3.22 m. s.l.m.

SCALA DISTANZE 1:100  
 SCALA QUOTE 1:100

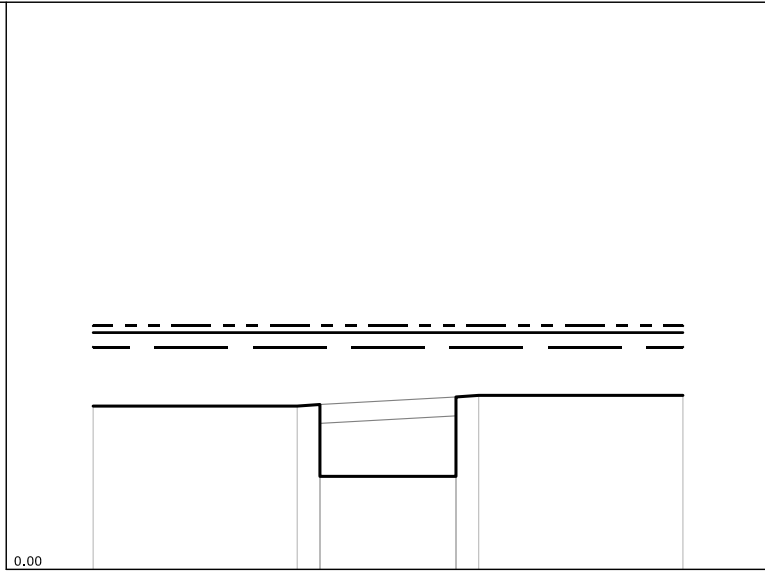

PUNTI	1	2	3	6	9	10
QUOTE [m s.l.m.]	2.16	2.16	2.18	1.23	2.30	2.30
DISTANZE PROGRESSIVE [m]	0.00	2.70	3.00	4.80	5.10	7.80
DISTANZE PARZIALI [m]		2.70		1.80		2.70



Fosso del Due Canali  
 SEZIONE N° 00125PD06

LEGENDA:

- TR30 H =2.94 m. s.l.m.
- TR200 H =3.13 m. s.l.m.
- TR500 H =3.22 m. s.l.m.

SCALA DISTANZE 1:100  
 SCALA QUOTE 1:100

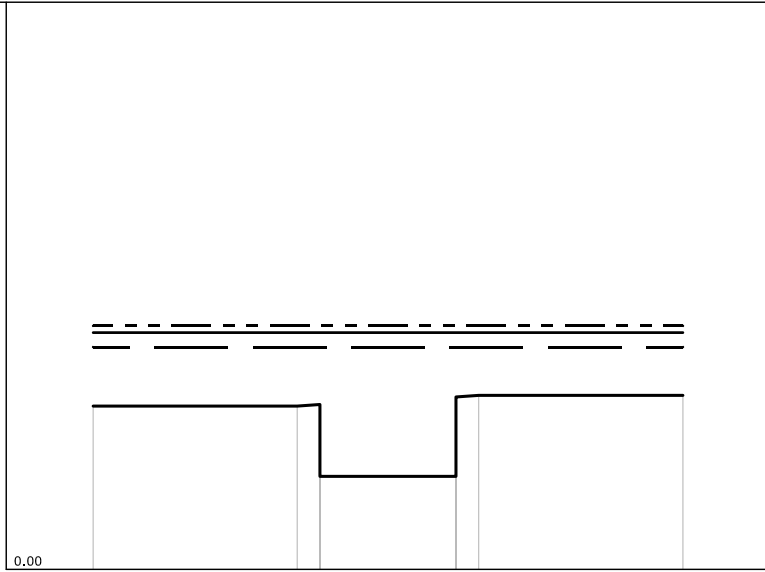

PUNTI	1	2	3	5	7	8
QUOTE [m s.l.m.]	2.16	2.16	2.16	1.23	2.30	2.30
DISTANZE PROGRESSIVE [m]	0.00	2.70	3.00	4.80	5.10	7.80
DISTANZE PARZIALI [m]		2.70		1.80		2.70

Fosso del Due Canali  
 SEZIONE N° 00122\_\_06

LEGENDA:

TR30 H = 2.94 m. s.l.m. ————

TR200 H = 3.13 m. s.l.m. ————

TR500 H = 3.22 m. s.l.m. - - - - -

SCALA DISTANZE 1:100  
 SCALA QUOTE 1:100

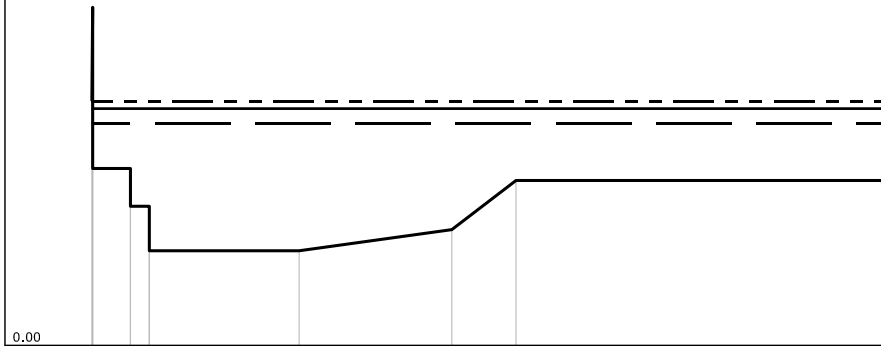

PUNTI	1	4	6	8	9	10	11
QUOTE [m s.l.m.]	3.24	2.34	1.84	1.25	1.53	2.18	2.18
DISTANZE PROGRESSIVE [m]	0.00	0.51	0.76	2.74	4.76	5.61	10.61
DISTANZE PARZIALI [m]	0.50		1.98		2.02	0.85	5.00

Fosso del Due Canali  
 SEZIONE N° 00116\_\_06

LEGENDA:

TR30 H = 2,92 m. s.l.m.

TR200 H = 3,11 m. s.l.m.

TR500 H = 3,21 m. s.l.m.

SCALA DISTANZE 1:100  
 SCALA QUOTE 1:100

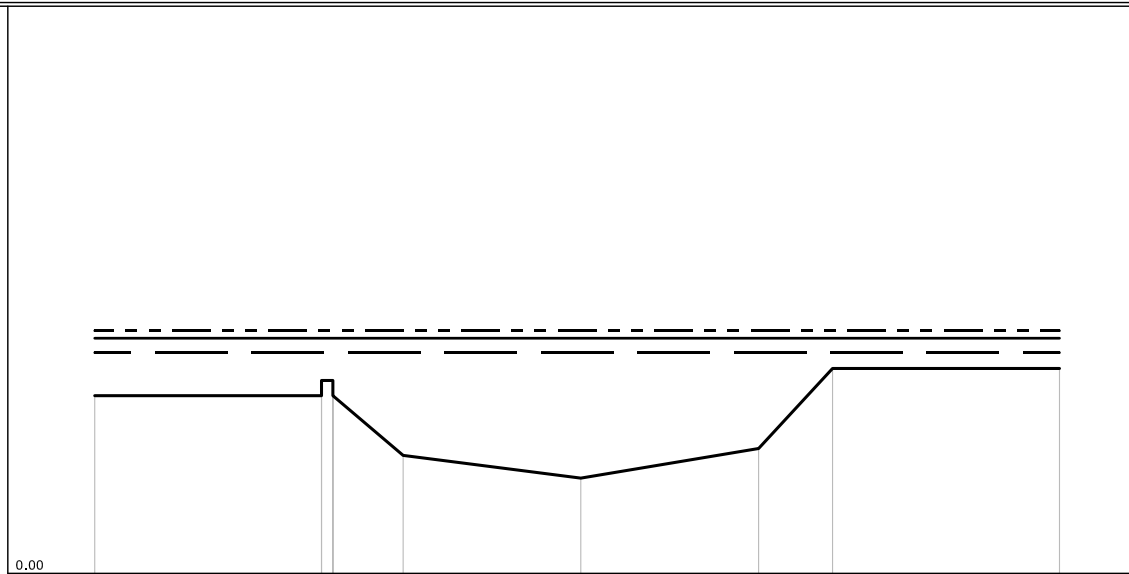

PUNTI	1	2	4	6	7	8	9	10
QUOTE [m s.l.m.]	2.35	2.35	2.35	1.56	1.26	1.65	2.71	2.71
DISTANZE PROGRESSIVE [m]	0.00	3.00	3.15	4.08	6.43	8.78	9.76	12.76
DISTANZE PARZIALI [m]		3.00	0.93	2.35	2.35	0.98	3.00	

Fosso del Due Canali  
 SEZIONE N° 00111\_\_06

LEGENDA:

TR30 H =2.89 m. s.l.m. ————

TR200 H =3.10 m. s.l.m. ————

TR500 H =3.21 m. s.l.m. - - - - -

SCALA DISTANZE 1:100  
 SCALA QUOTE 1:100

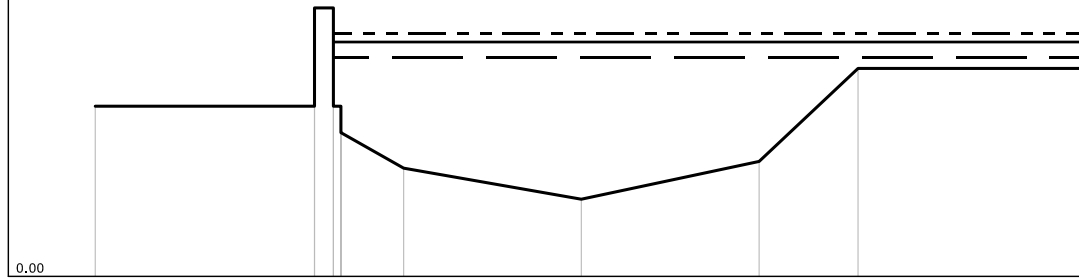

PUNTI	1	2	4	8	9	10	11	12
QUOTE [m s.l.m.]	2.25	2.25	3.55	1.43	1.02	1.52	2.75	2.75
DISTANZE PROGRESSIVE [m]	0.00	2.90	3.15	4.08	6.43	8.78	10.09	13.09
DISTANZE PARZIALI [m]		2.90	0.83	2.35	2.35	1.31	3.00	

Fosso def Due Canali  
 SEZIONE N° 00106\_\_06

LEGENDA:

TR30 H =2.90 m. s.l.m. \_\_\_\_\_

TR200 H =3.11 m. s.l.m. \_\_\_\_\_

TR500 H =3.21 m. s.l.m. \_\_\_\_\_

SCALA DISTANZE 1:100  
 SCALA QUOTE 1:100

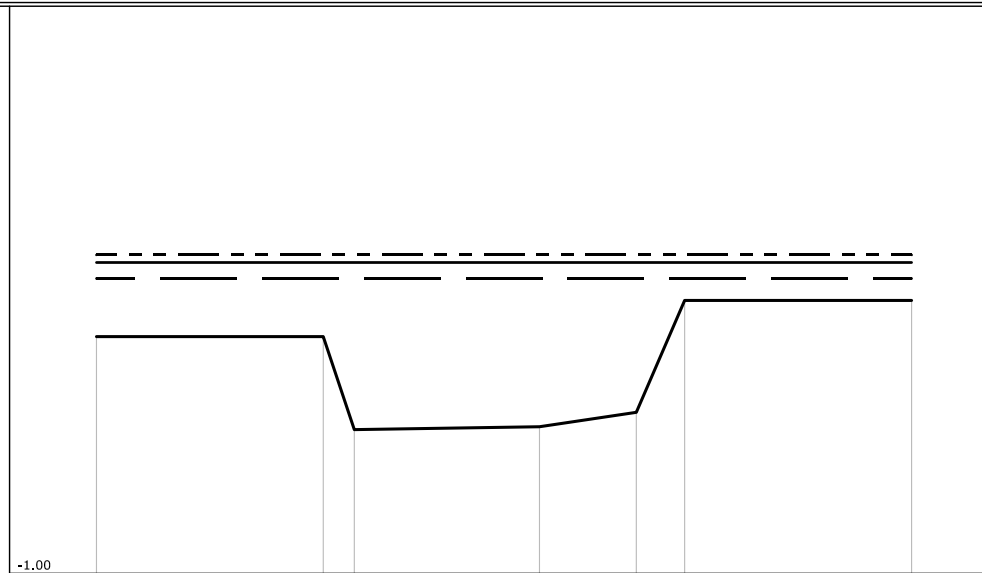

PUNTI	1	2	3	4	5	6	7
QUOTE [m s.l.m.]	2.13	2.13	0.90	0.94	1.13	2.61	2.61
DISTANZE PROGRESSIVE [m]	0.00	3.00	3.41	5.86	7.14	7.78	10.78
DISTANZE PARZIALI [m]		3.00		2.45	1.28	0.64	3.00

Fosso del Due Canali  
 SEZIONE N° 00105PA06

LEGENDA:

TR30 H = 2.91 m. s.l.m.

TR200 H = 3.11 m. s.l.m.

TR500 H = 3.21 m. s.l.m.

SCALA DISTANZE 1:100  
 SCALA QUOTE 1:100

-1.00

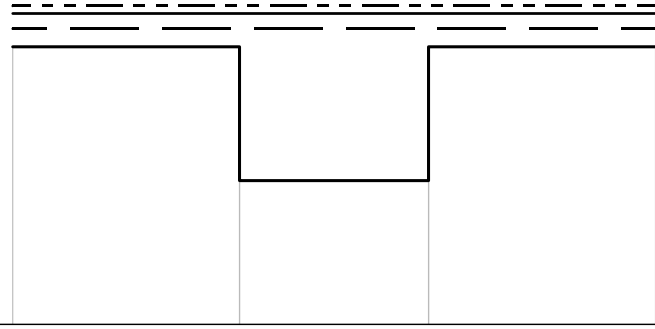

PUNTI	1	2	5	8
QUOTE [m s.l.m.]	2.67	2.67	0.90	2.67
DISTANZE PROGRESSIVE [m]	0.00	3.00	5.50	8.50
DISTANZE PARZIALI [m]		3.00	2.50	3.00

Fosso del Due Canali  
 SEZIONE N° 00105PB06

LEGENDA:

TR30 H = 2.91 m. s.l.m.

TR200 H = 3.11 m. s.l.m.

TR500 H = 3.21 m. s.l.m.

SCALA DISTANZE 1:100  
 SCALA QUOTE 1:100

-1.00

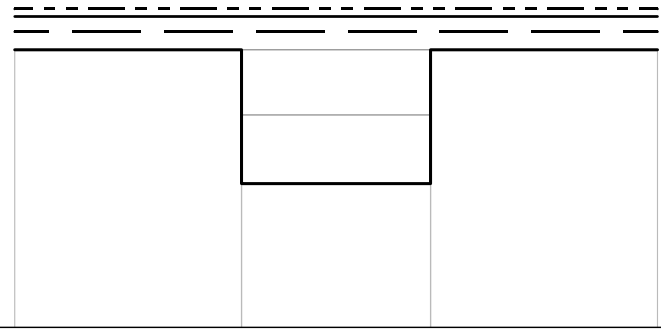

PUNTI	1	3	6	9
QUOTE [m s.l.m.]	2.67	2.67	0.90	2.67
DISTANZE PROGRESSIVE [m]	0.00	3.00	5.50	8.50
DISTANZE PARZIALI [m]		3.00	2.50	3.00

Fosso del Due Canali  
 SEZIONE N° 00105PC06

LEGENDA:

TR30 H = 2.88 m. s.l.m. ———

TR200 H = 3.10 m. s.l.m. ———

TR500 H = 3.20 m. s.l.m. - - - - -

SCALA DISTANZE 1:100  
 SCALA QUOTE 1:100

-1.00

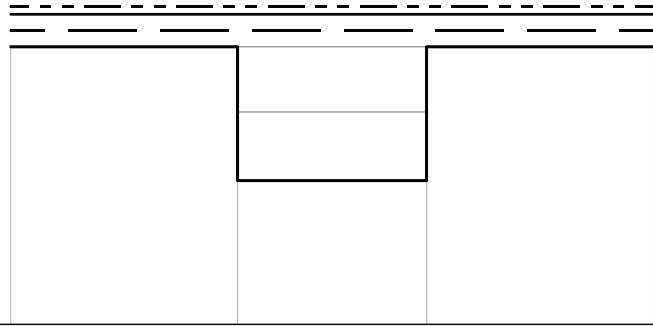

PUNTI	1	3	6	9
QUOTE [m s.l.m.]	2.67	2.67	0.90	2.67
DISTANZE PROGRESSIVE [m]	0.00	3.00	5.50	8.50
DISTANZE PARZIALI [m]		3.00	2.50	3.00



Fosso del Due Canali  
 SEZIONE N° 00105PD06

LEGENDA:

TR30 H = 2.88 m. s.l.m.

TR200 H = 3.10 m. s.l.m.

TR500 H = 3.20 m. s.l.m.

SCALA DISTANZE 1:100  
 SCALA QUOTE 1:100

-1.00

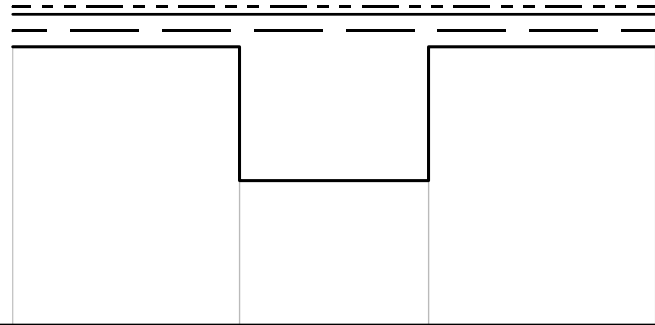

PUNTI	1	2	5	8
QUOTE [m s.l.m.]	2.67	2.67	0.90	2.67
DISTANZE PROGRESSIVE [m]	0.00	3.00	5.50	8.50
DISTANZE PARZIALI [m]		3.00	2.50	3.00

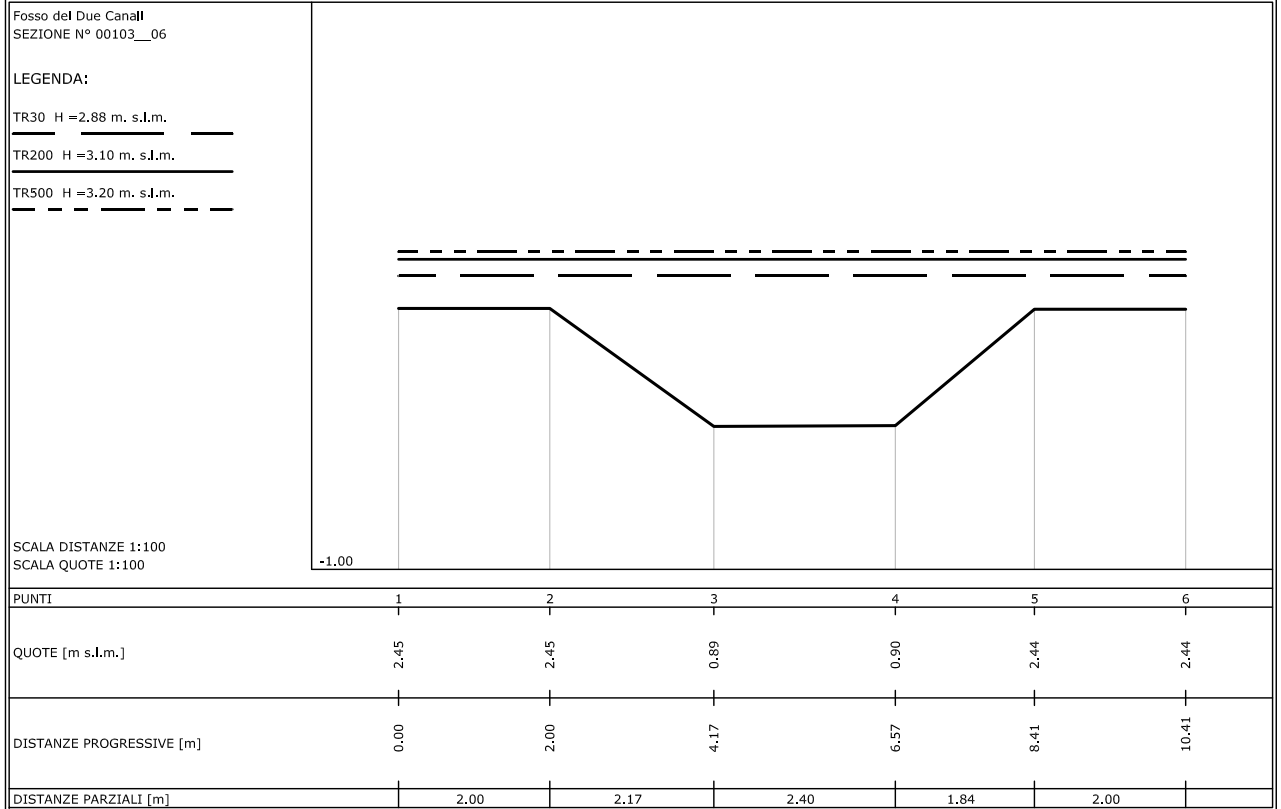

Fosso del Due Canali  
 SEZIONE N° 00101\_\_06

LEGENDA:

- TR30 H = 2.88 m. s.l.m.
- TR200 H = 3.09 m. s.l.m.
- TR500 H = 3.20 m. s.l.m.

SCALA DISTANZE 1:100  
 SCALA QUOTE 1:100

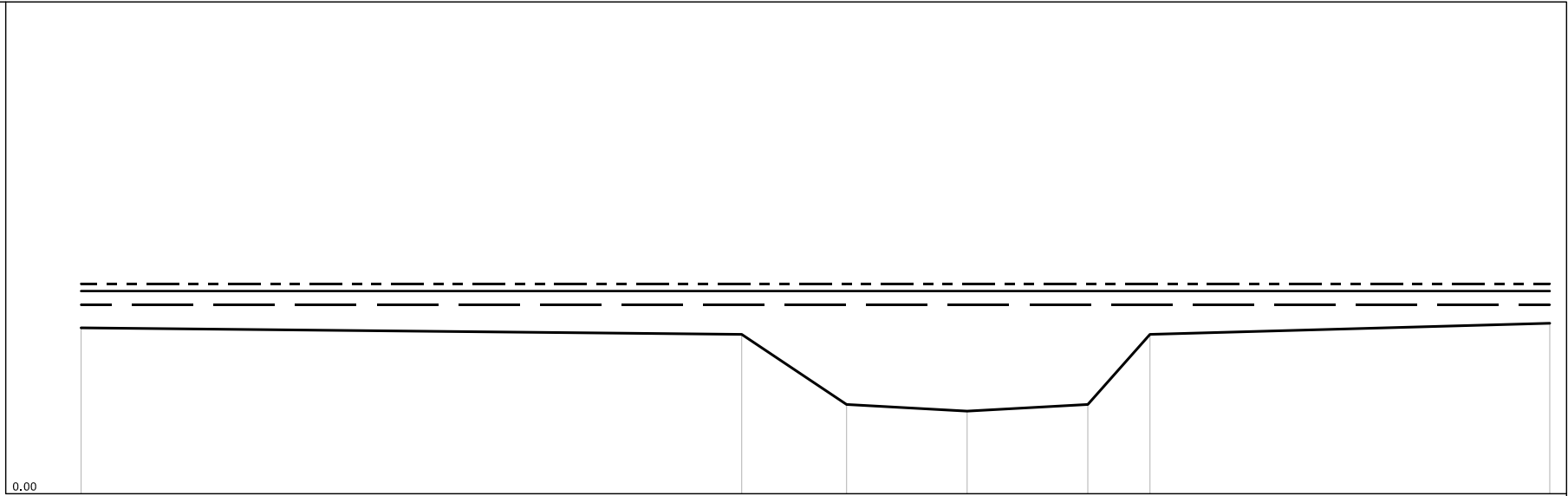



PUNTI	1	2	3	4	5	6	7
QUOTE [m s.l.m.]	2.53	2.43	1.36	1.26	1.36	2.43	2.60
DISTANZE PROGRESSIVE [m]	0.00	10.08	11.68	13.52	15.36	16.31	22.41
DISTANZE PARZIALI [m]		10.08	1.60	1.84	1.84	0.95	6.10

Fosso del Due Canali  
 SEZIONE N° 00097\_\_06

LEGENDA:

TR30 H = 2.88 m. s.l.m. 

TR200 H = 3.09 m. s.l.m. 

TR500 H = 3.20 m. s.l.m. 

SCALA DISTANZE 1:100  
 SCALA QUOTE 1:100

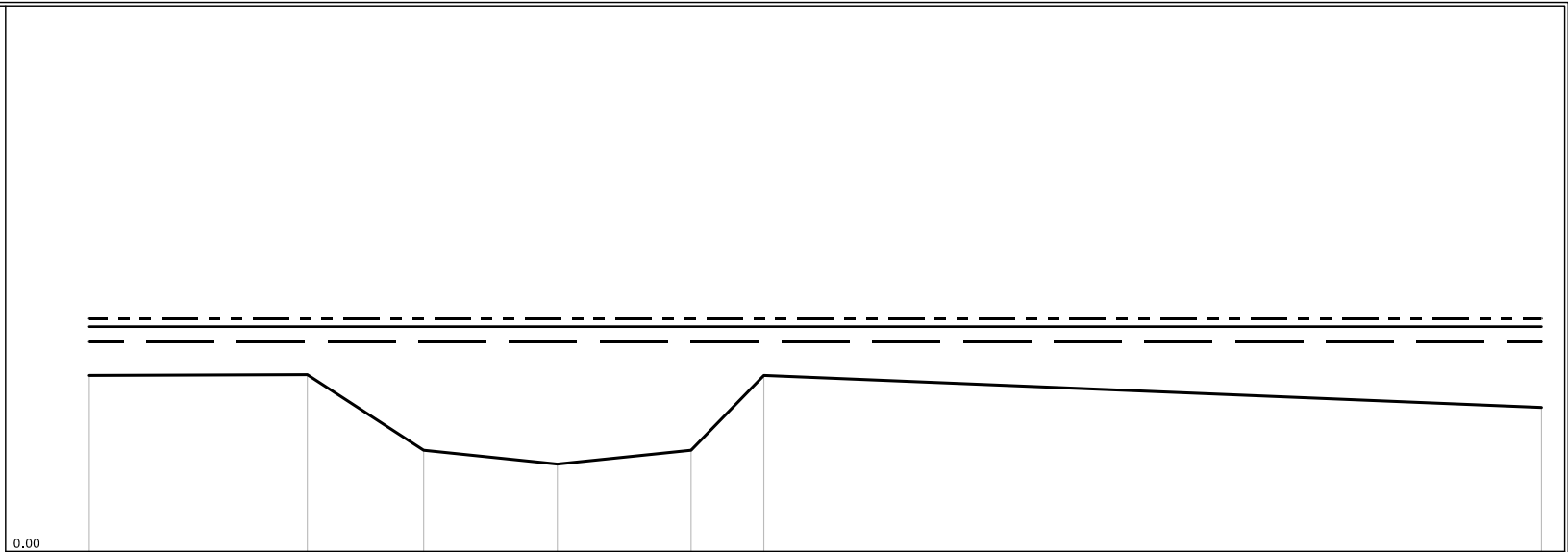

PUNTI	1	2	3	4	5	6	7
QUOTE [m s.l.m.]	2.42	2.43	1.39	1.20	1.39	2.42	1.98
DISTANZE PROGRESSIVE [m]	0.00	3.00	4.60	6.44	8.28	9.28	19.98
DISTANZE PARZIALI [m]		3.00	1.60	1.84	1.84	1.00	10.70

Fosso del Due Canali  
 SEZIONE N° 00094\_\_06

LEGENDA:

TR30 H =2.87 m. s.l.m. ———

TR200 H =3.09 m. s.l.m. ———

TR500 H =3.19 m. s.l.m. - - - - -

SCALA DISTANZE 1:100  
 SCALA QUOTE 1:100

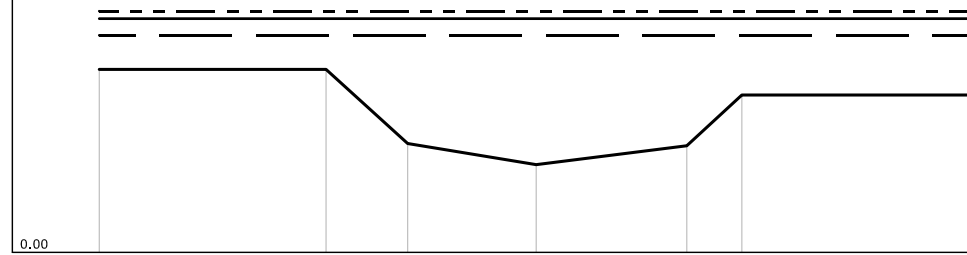



PUNTI	1	2	3	4	5	6	7
QUOTE [m s.l.m.]	2.42	2.42	1.44	1.16	1.41	2.08	2.08
DISTANZE PROGRESSIVE [m]	0.00	3.00	4.08	5.78	7.77	8.50	11.50
DISTANZE PARZIALI [m]		3.00	1.08	1.70	1.99	0.73	3.00

Fosso def Due Canali  
 SEZIONE N° 00093PA06

LEGENDA:

TR30 H =2.87 m. s.l.m. 

TR200 H =3.09 m. s.l.m. 

TR500 H =3.19 m. s.l.m. 

SCALA DISTANZE 1:100  
 SCALA QUOTE 1:100

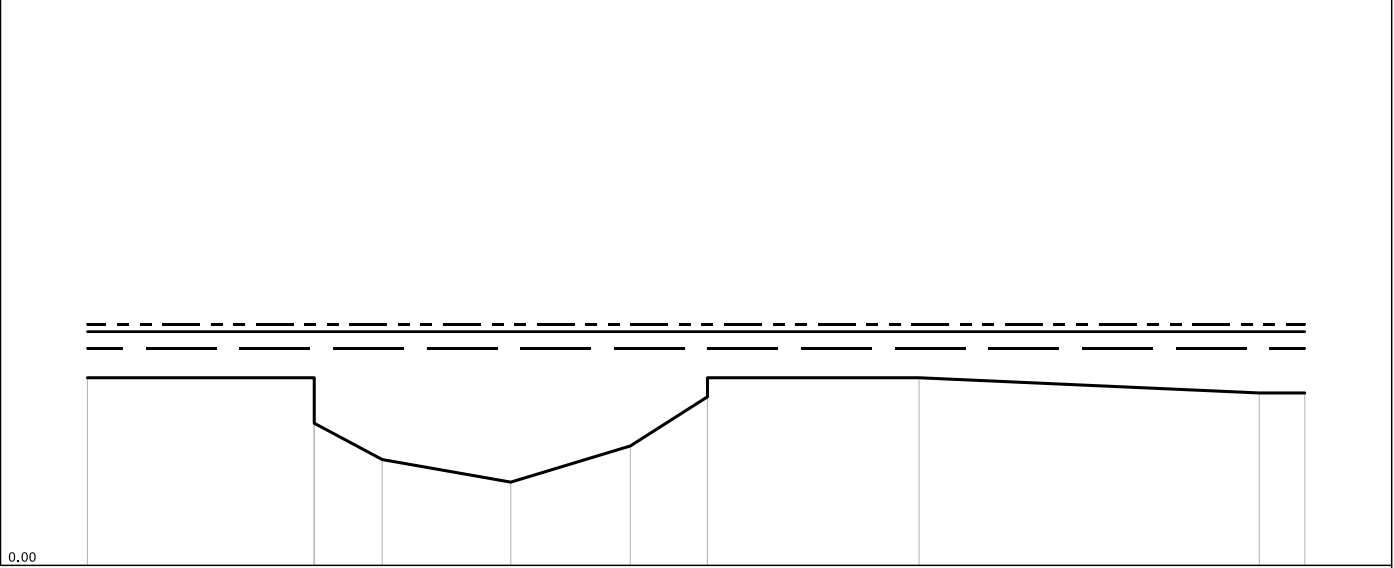

PUNTI	1	2	4	5	6	7	9	10	11
QUOTE [m s.l.m.]	2.48	2.48	1.40	1.10	1.58	2.23	2.48	2.28	2.28
DISTANZE PROGRESSIVE [m]	0.00	3.00	3.90	5.60	7.18	8.20	11.00	15.50	16.10
DISTANZE PARZIALI [m]		3.00	0.90	1.70	1.58	1.02	2.80	4.50	0.60

Fosso def Due Canali  
 SEZIONE N° 00093PB06

LEGENDA:

TR30 H =2.87 m. s.l.m. ———

TR200 H =3.09 m. s.l.m. ———

TR500 H =3.19 m. s.l.m. - - - - -

SCALA DISTANZE 1:100  
 SCALA QUOTE 1:100

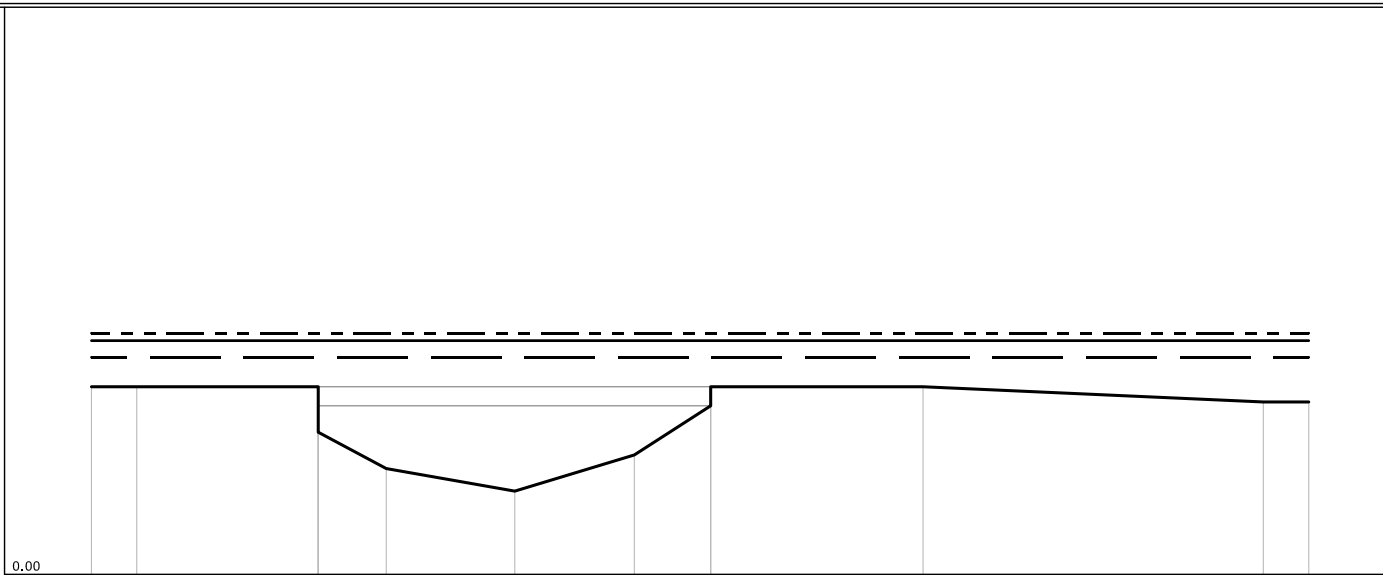

PUNTI	1	2	3	6	7	8	9	11	12	13
QUOTE [m s.l.m.]	2.48	2.48	2.48	1.40	1.10	1.58	2.23	2.48	2.28	2.28
DISTANZE PROGRESSIVE [m]	0.00	0.60	3.00	3.90	5.60	7.18	8.19	11.00	15.50	16.10
DISTANZE PARZIALI [m]	0.60	2.40	0.90	1.70	1.58	1.01	2.81	4.50	0.60	

Fosso def Due Canali  
 SEZIONE N° 00093PC06

LEGENDA:

TR30 H =2.83 m. s.l.m. ———

TR200 H =3.07 m. s.l.m. ———

TR500 H =3.16 m. s.l.m. - - - - -

SCALA DISTANZE 1:100  
 SCALA QUOTE 1:100

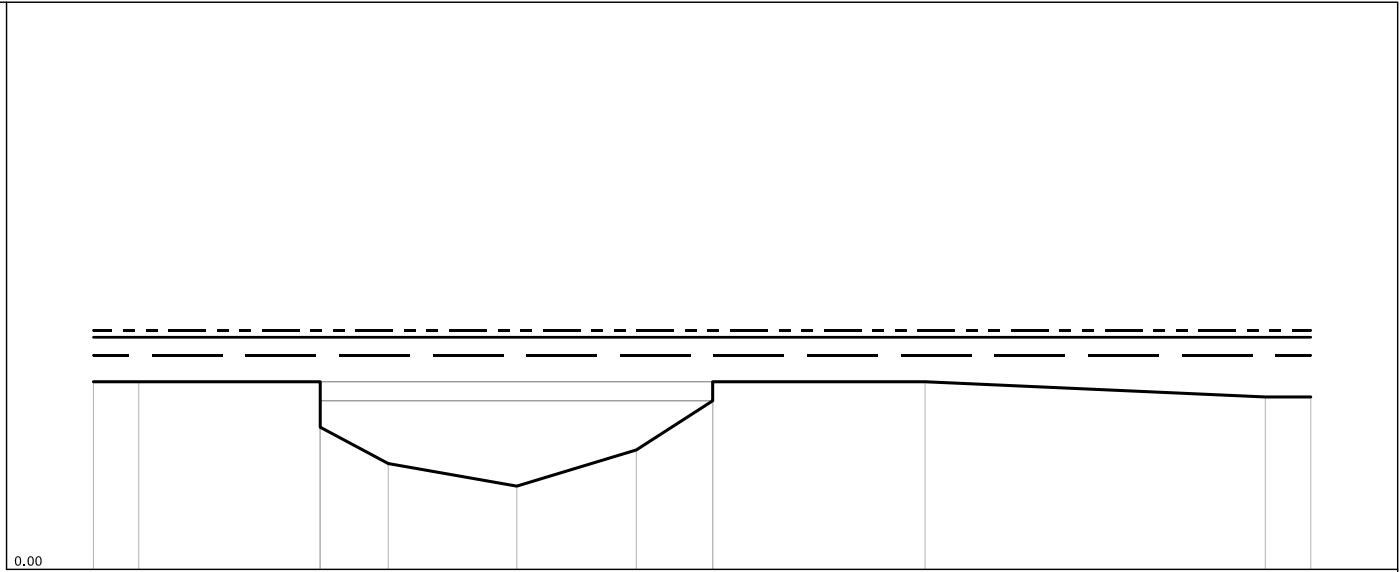



PUNTI	1	2	3	6	7	8	9	11	12	13
QUOTE [m s.l.m.]	2.48	2.48	2.48	1.40	1.10	1.58	2.23	2.48	2.28	2.28
DISTANZE PROGRESSIVE [m]	0.00	0.60	3.00	3.90	5.60	7.18	8.19	11.00	15.50	16.10
DISTANZE PARZIALI [m]	0.60	2.40	0.90	1.70	1.58	1.01	2.81	4.50	0.60	



Fosso def Due Canali  
 SEZIONE N° 00093PD06

LEGENDA:

TR30 H =2.83 m. s.l.m. 

TR200 H =3.06 m. s.l.m. 

TR500 H =3.16 m. s.l.m. 

SCALA DISTANZE 1:100  
 SCALA QUOTE 1:100

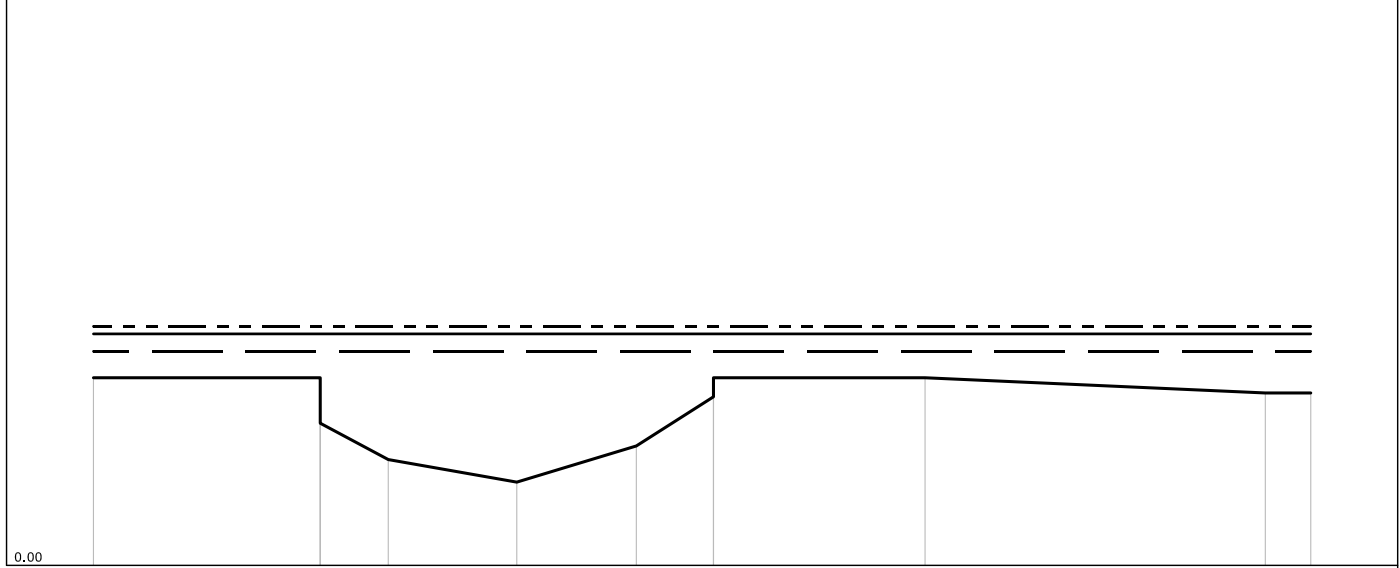

PUNTI	1	2	4	5	6	7	9	10	11
QUOTE [m s.l.m.]	2.48	2.48	1.40	1.10	1.58	2.23	2.48	2.28	2.28
DISTANZE PROGRESSIVE [m]	0.00	3.00	3.90	5.60	7.18	8.20	11.00	15.50	16.10
DISTANZE PARZIALI [m]		3.00	0.90	1.70	1.58	1.02	2.80	4.50	0.60

Fosso del Due Canali  
 SEZIONE N° 00092\_\_06

LEGENDA:

TR30 H =2.83 m. s.l.m. ———

TR200 H =3.06 m. s.l.m. ———

TR500 H =3.16 m. s.l.m. - - - - -

SCALA DISTANZE 1:100  
 SCALA QUOTE 1:100

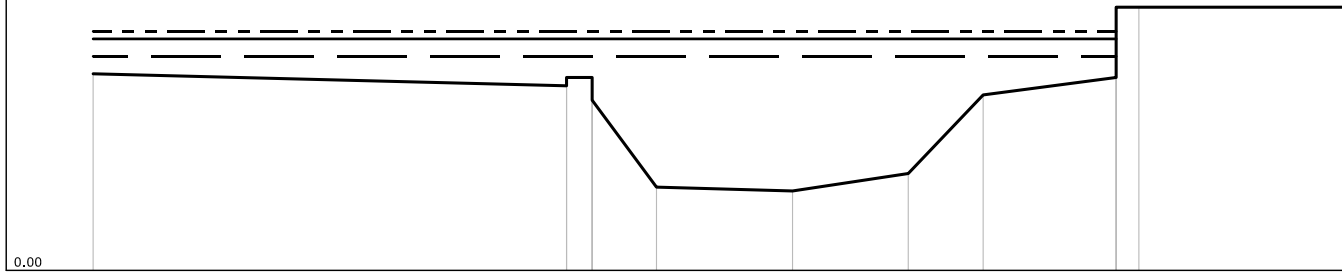

PUNTI	1	2	4	6	7	8	9	10	12	13
QUOTE [m s.l.m.]	2.60	2.44	2.55	1.10	1.05	1.28	2.32	2.55	3.48	3.48
DISTANZE PROGRESSIVE [m]	0.00	6.26	6.60	7.45	9.25	10.78	11.77	13.53	13.83	16.53
DISTANZE PARZIALI [m]		6.26	0.85	1.80	1.53	0.99	1.76	2.70		

Fosso del Due Canali  
 SEZIONE N° 00087\_06

LEGENDA:

TR30 H = 2.81 m. s.l.m. ———

TR200 H = 3.07 m. s.l.m. ———

TR500 H = 3.16 m. s.l.m. - - - - -

SCALA DISTANZE 1:100  
 SCALA QUOTE 1:100

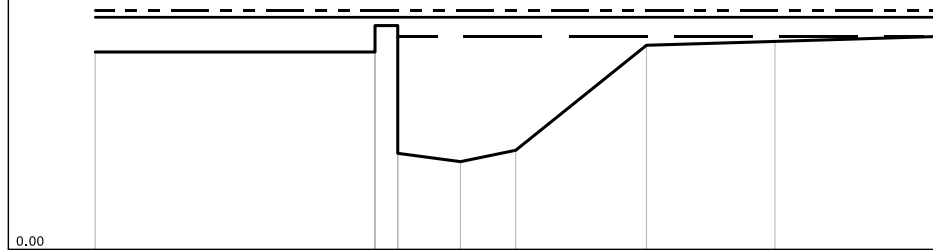

PUNTI	1	2	4	6	7	8	9	10
QUOTE [m s.l.m.]	2.61	2.61	2.96	1.16	1.31	2.70	2.75	2.82
DISTANZE PROGRESSIVE [m]	0.00	3.70	4.00	4.83	5.56	7.29	8.99	11.29
DISTANZE PARZIALI [m]		3.70	0.83	0.73	1.73	1.70	2.30	

Fosso del Due Canali  
 SEZIONE N° 00085\_\_06

LEGENDA:

TR30 H = 2.81 m. s.l.m. ———

TR200 H = 3.06 m. s.l.m. ———

TR500 H = 3.16 m. s.l.m. - - - - -

SCALA DISTANZE 1:100  
 SCALA QUOTE 1:100

0.00

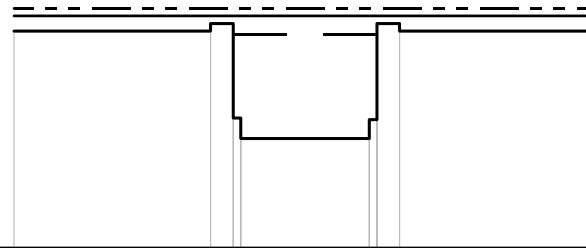

PUNTI	1	2	4	8	12	14
QUOTE [m s.l.m.]	2.86	2.86	2.96	1.44	2.96	2.86
DISTANZE PROGRESSIVE [m]	0.00	2.60	2.90	4.70	5.10	7.70
DISTANZE PARZIALI [m]		2.60		1.70		2.60

Fosso del Due Canali  
 SEZIONE N° 00082PA06

LEGENDA:

- TR30 H = 2.80 m. s.l.m.
- TR200 H = 3.06 m. s.l.m.
- TR500 H = 3.17 m. s.l.m.

SCALA DISTANZE 1:100  
 SCALA QUOTE 1:100

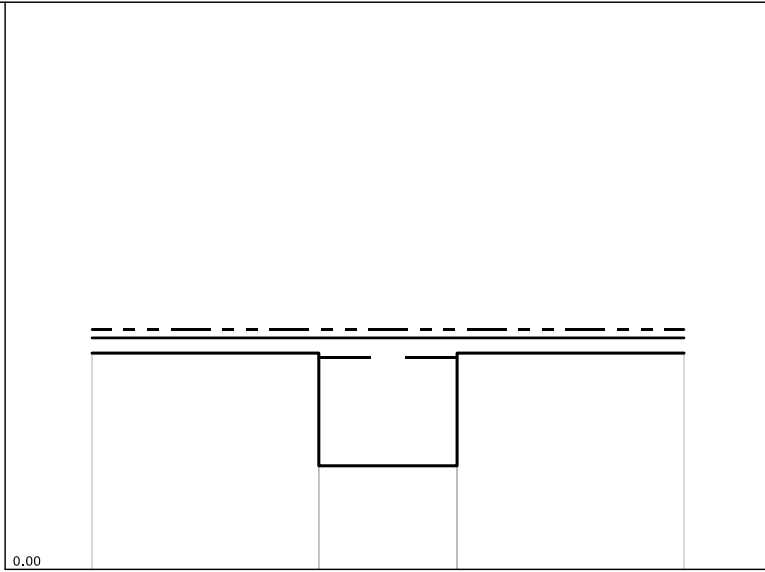

PUNTI	1	2	4	6
QUOTE [m s.l.m.]	2.86	2.86	1.37	2.86
DISTANZE PROGRESSIVE [m]	0.00	3.00	4.83	7.83
DISTANZE PARZIALI [m]		3.00	1.83	3.00







Fosso del Due Canali  
 SEZIONE N° 00079PB06

LEGENDA:

TR30 H = 2.77 m. s.l.m. 

TR200 H = 3.04 m. s.l.m. 

TR500 H = 3.14 m. s.l.m. 

SCALA DISTANZE 1:100  
 SCALA QUOTE 1:100

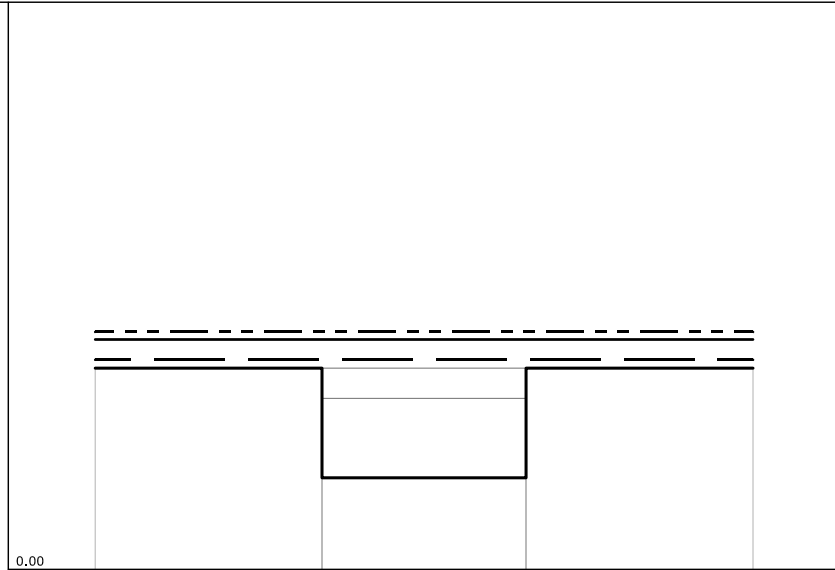

PUNTI	1	3	6	9
QUOTE [m s.l.m.]	2.66	2.66	1.21	2.66
DISTANZE PROGRESSIVE [m]	0.00	3.00	5.70	8.70
DISTANZE PARZIALI [m]		3.00	2.70	3.00



Fosso del Due Canali  
 SEZIONE N° 00079PC06

LEGENDA:

TR30 H = 2.75 m. s.l.m. ———

TR200 H = 3.03 m. s.l.m. ———

TR500 H = 3.13 m. s.l.m. - - - - -

SCALA DISTANZE 1:100  
 SCALA QUOTE 1:100

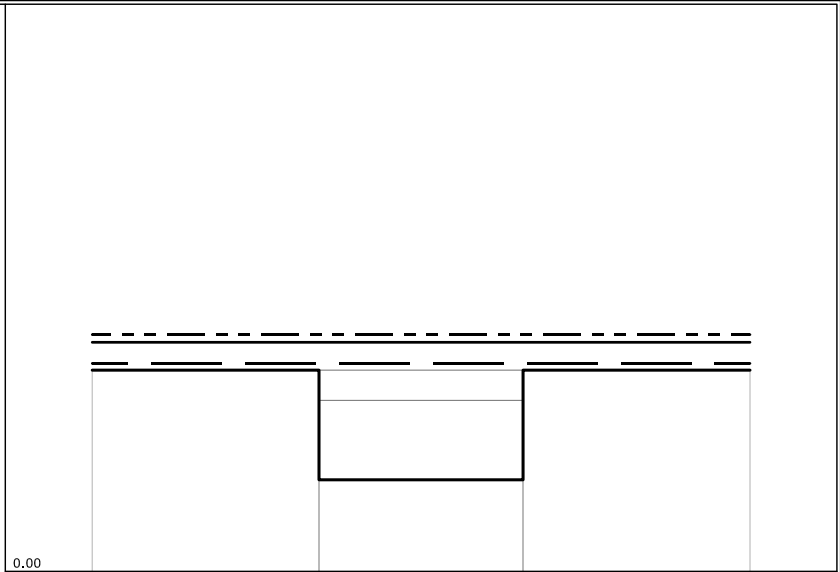



PUNTI	1	3	6	9
QUOTE [m s.l.m.]	2.66	2.66	1.21	2.66
DISTANZE PROGRESSIVE [m]	0.00	3.00	5.70	8.70
DISTANZE PARZIALI [m]		3.00	2.70	3.00

Fosso del Due Canali  
 SEZIONE N° 00079PD06

LEGENDA:

TR30 H = 2.74 m. s.l.m. 

TR200 H = 3.03 m. s.l.m. 

TR500 H = 3.12 m. s.l.m. 

SCALA DISTANZE 1:100  
 SCALA QUOTE 1:100

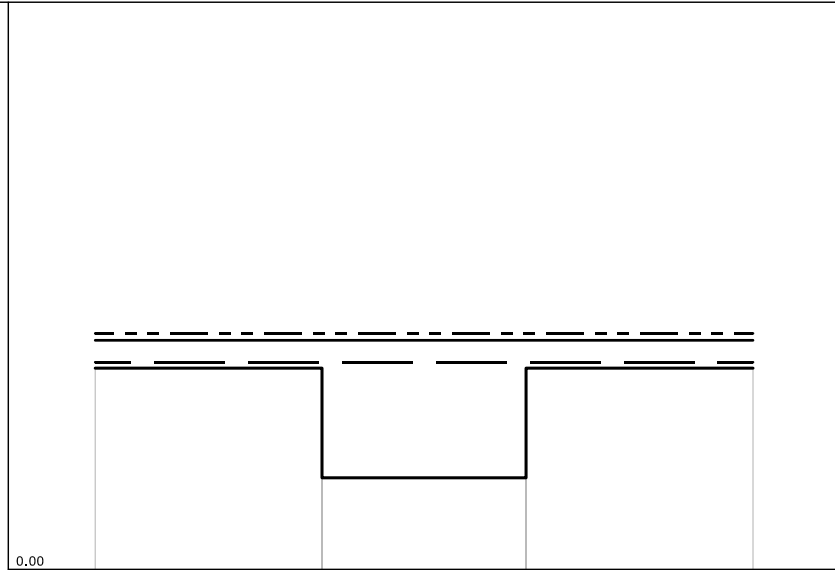

PUNTI	1	2	4	6
QUOTE [m s.l.m.]	2.66	2.66	1.21	2.66
DISTANZE PROGRESSIVE [m]	0.00	3.00	5.70	8.70
DISTANZE PARZIALI [m]		3.00	2.70	3.00

Fosso del Due Canali  
 SEZIONE N° 00078\_\_06

LEGENDA:

TR30 H = 2.75 m. s.l.m. ———

TR200 H = 3.03 m. s.l.m. ———

TR500 H = 3.12 m. s.l.m. - - - - -

SCALA DISTANZE 1:100  
 SCALA QUOTE 1:100

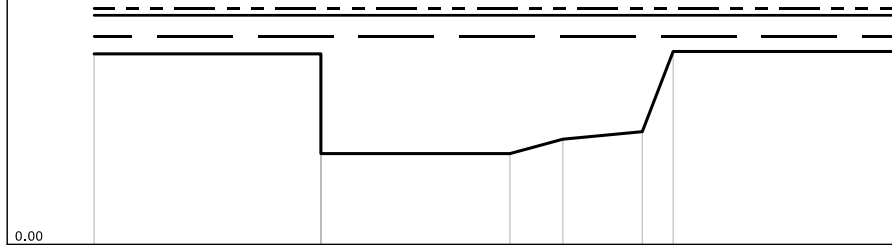

PUNTI	1	2	4	5	6	7	8
QUOTE [m s.l.m.]	2.52	2.52	1.20	1.39	1.49	2.55	2.55
DISTANZE PROGRESSIVE [m]	0.00	3.00	5.50	6.20	7.25	7.66	10.66
DISTANZE PARZIALI [m]		3.00	2.50	0.70	1.05		3.00

Fosso del Due Canali  
 SEZIONE N° 00073\_\_06

LEGENDA:

TR30 H = 2,74 m. s.l.m. \_\_\_\_\_

TR200 H = 3,02 m. s.l.m. \_\_\_\_\_

TR500 H = 3,12 m. s.l.m. - - - - -

SCALA DISTANZE 1:100  
 SCALA QUOTE 1:100

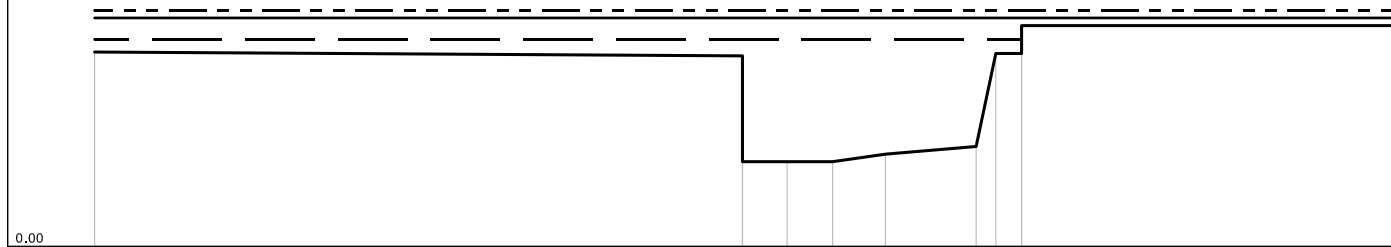

PUNTI	1		2	4	5	6		7	8	9		11
QUOTE [m s.l.m.]	2.57		2.52	1.12	1.12	1.22		1.32	2.55	2.55		2.92
DISTANZE PROGRESSIVE [m]	0.00		8.57	9.16	9.76	10.46		11.66	11.92	12.26		17.26
DISTANZE PARZIALI [m]		8.57		0.59	0.60	0.70	1.20				5.00	

Fosso del Due Canali  
 SEZIONE N° 00066\_\_06

LEGENDA:

TR30 H = 2.73 m. s.l.m. ————

TR200 H = 3.03 m. s.l.m. ————

TR500 H = 3.13 m. s.l.m. - - - - -

SCALA DISTANZE 1:100  
 SCALA QUOTE 1:100

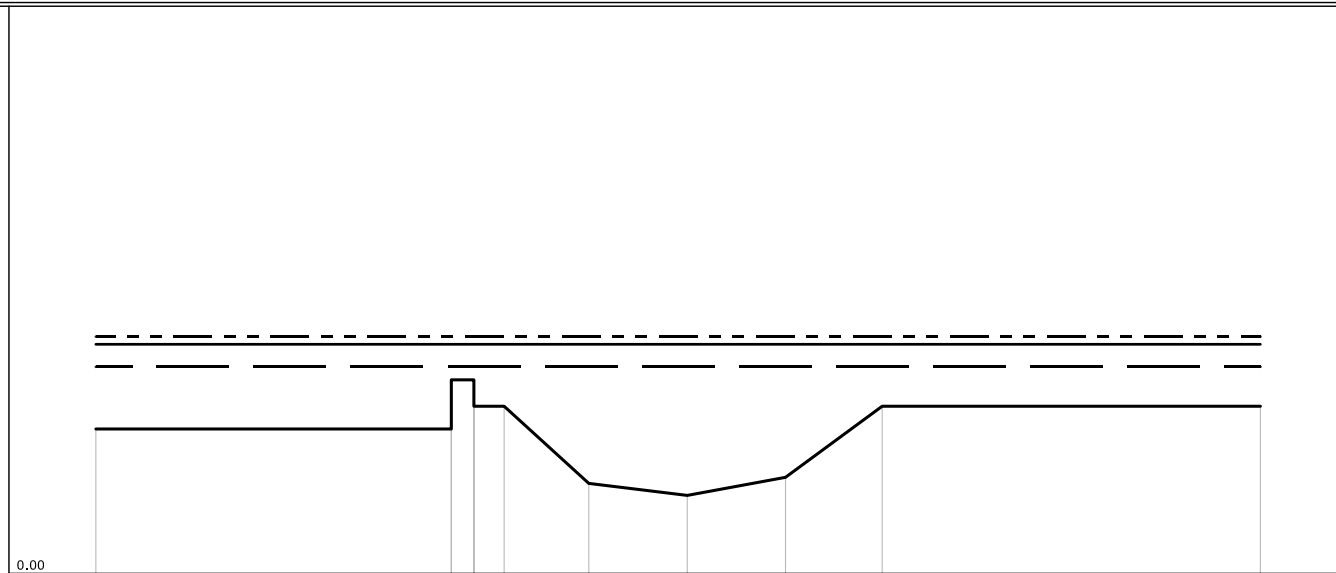



PUNTI	1	2	4	6	7	8	9	10	11
QUOTE [m s.l.m.]	1.91	1.91	2.56	2.21	1.19	1.03	1.27	2.21	2.21
DISTANZE PROGRESSIVE [m]	0.00	4.70	5.00	5.40	6.52	7.82	9.12	10.40	15.40
DISTANZE PARZIALI [m]		4.70			1.12	1.30	1.30	1.28	5.00

Fosso del Due Canali  
 SEZIONE N° 00062\_\_06

LEGENDA:

TR30 H = 2.73 m. s.l.m. 

TR200 H = 3.03 m. s.l.m. 

TR500 H = 3.13 m. s.l.m. 

SCALA DISTANZE 1:100  
 SCALA QUOTE 1:100

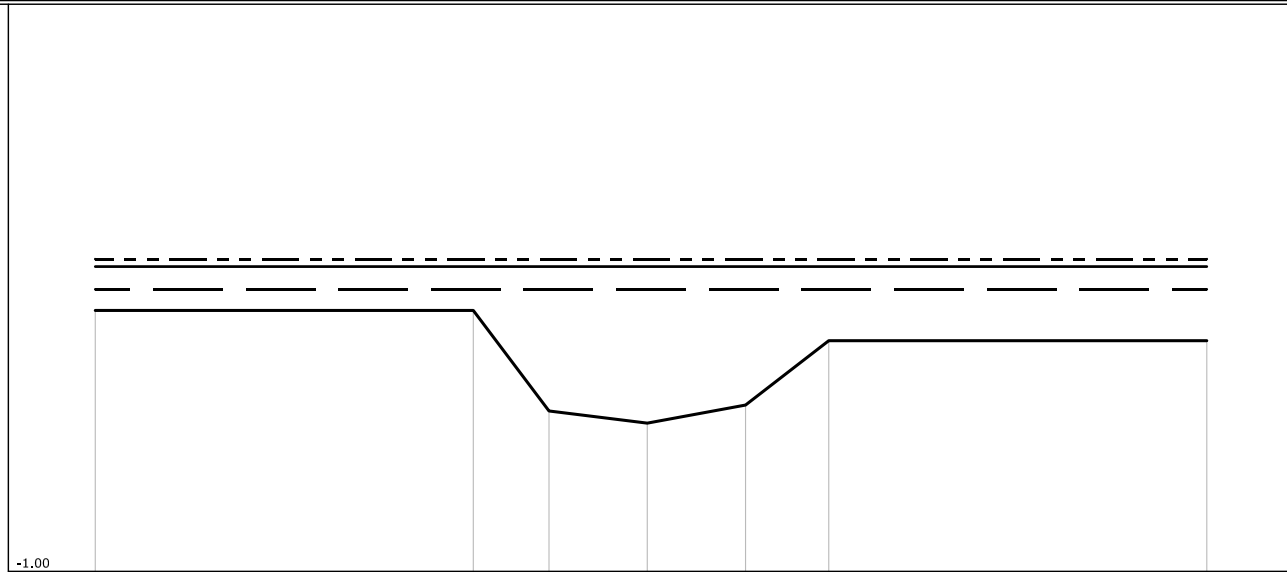

PUNTI	1	2	3	4	5	6	7
QUOTE [m s.l.m.]	2.45	2.45	1.12	0.96	1.20	2.05	2.05
DISTANZE PROGRESSIVE [m]	0.00	5.00	6.00	7.30	8.60	9.70	14.70
DISTANZE PARZIALI [m]		5.00	1.00	1.30	1.30	1.10	5.00

Fosso def Due Canali  
 SEZIONE N° 00056\_\_06

LEGENDA:

TR30 H =2.73 m. s.l.m. \_\_\_\_\_

TR200 H =3.04 m. s.l.m. \_\_\_\_\_

TR500 H =3.14 m. s.l.m. \_\_\_\_\_

SCALA DISTANZE 1:100  
 SCALA QUOTE 1:100

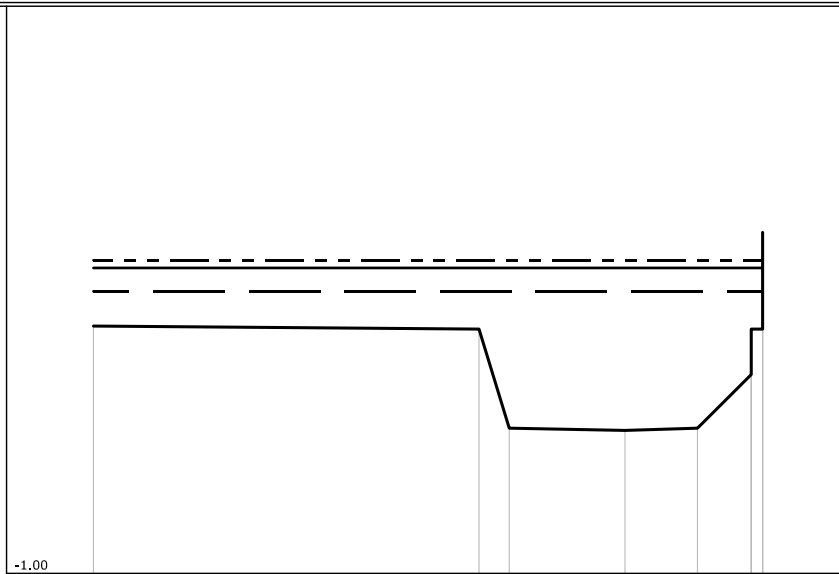

PUNTI	1	2	3	4	5	6	8
QUOTE [m s.l.m.]	2.27	2.23	0.92	0.89	0.92	1.63	2.23
DISTANZE PROGRESSIVE [m]	0.00	5.10	5.50	7.03	7.99	8.70	8.85
DISTANZE PARZIALI [m]		5.10		1.53	0.96	0.71	

Fosso del Due Canali  
 SEZIONE N° 0005SPA06

LEGENDA:

- TR30 H = 2.74 m. s.l.m.
- TR200 H = 3.04 m. s.l.m.
- TR500 H = 3.13 m. s.l.m.

SCALA DISTANZE 1:100  
 SCALA QUOTE 1:100

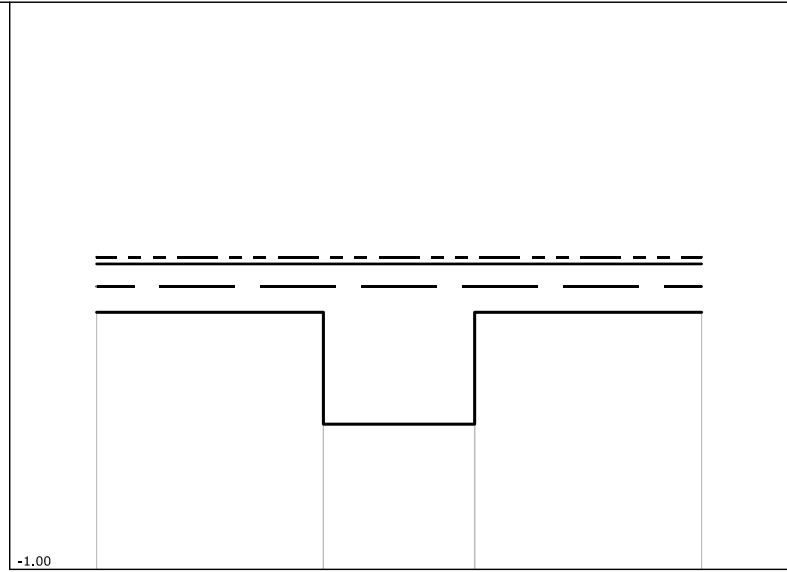

PUNTI	1	2	4	6
QUOTE [m s.l.m.]	2.40	2.40	0.92	2.40
DISTANZE PROGRESSIVE [m]	0.00	3.00	5.00	8.00
DISTANZE PARZIALI [m]		3.00	2.00	3.00







Fosso del Due Canali  
 SEZIONE N° 0005SPD06

LEGENDA:

- TR30 H = 2.72 m. s.l.m.
- TR200 H = 3.02 m. s.l.m.
- TR500 H = 3.11 m. s.l.m.

SCALA DISTANZE 1:100  
 SCALA QUOTE 1:100

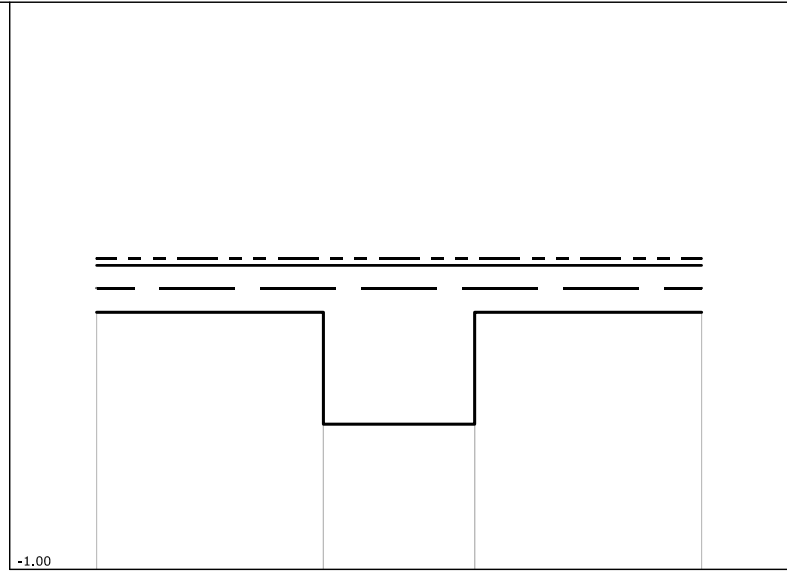

PUNTI	1	2	4	6
QUOTE [m s.l.m.]	2.40	2.40	0.92	2.40
DISTANZE PROGRESSIVE [m]	0.00	3.00	5.00	8.00
DISTANZE PARZIALI [m]		3.00	2.00	3.00

Fosso del Due Canali  
 SEZIONE N° 00054\_\_06

LEGENDA:

TR30 H = 2.72 m. s.l.m. ———

TR200 H = 3.02 m. s.l.m. ———

TR500 H = 3.11 m. s.l.m. - - - - -

SCALA DISTANZE 1:100  
 SCALA QUOTE 1:100

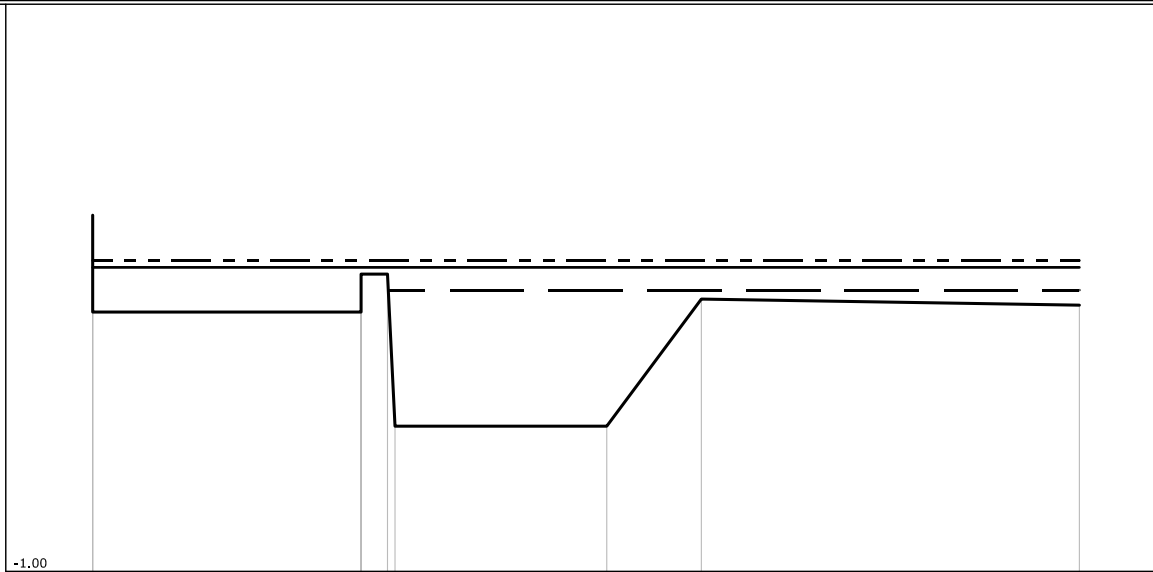

PUNTI	1	3	5	7	8	9
QUOTE [m s.l.m.]	3.71	2.43	2.93	0.92	2.60	2.52
DISTANZE PROGRESSIVE [m]	0.00	3.55	3.90	6.80	8.05	13.05
DISTANZE PARZIALI [m]		3.55		2.80	1.25	5.00

Fosso del Due Canali  
 SEZIONE N° 00051\_\_06

LEGENDA:

TR30 H =2.70 m. s.l.m. \_\_\_\_\_

TR200 H =3.00 m. s.l.m. \_\_\_\_\_

TR500 H =3.09 m. s.l.m. - - - - -

SCALA DISTANZE 1:100  
 SCALA QUOTE 1:100

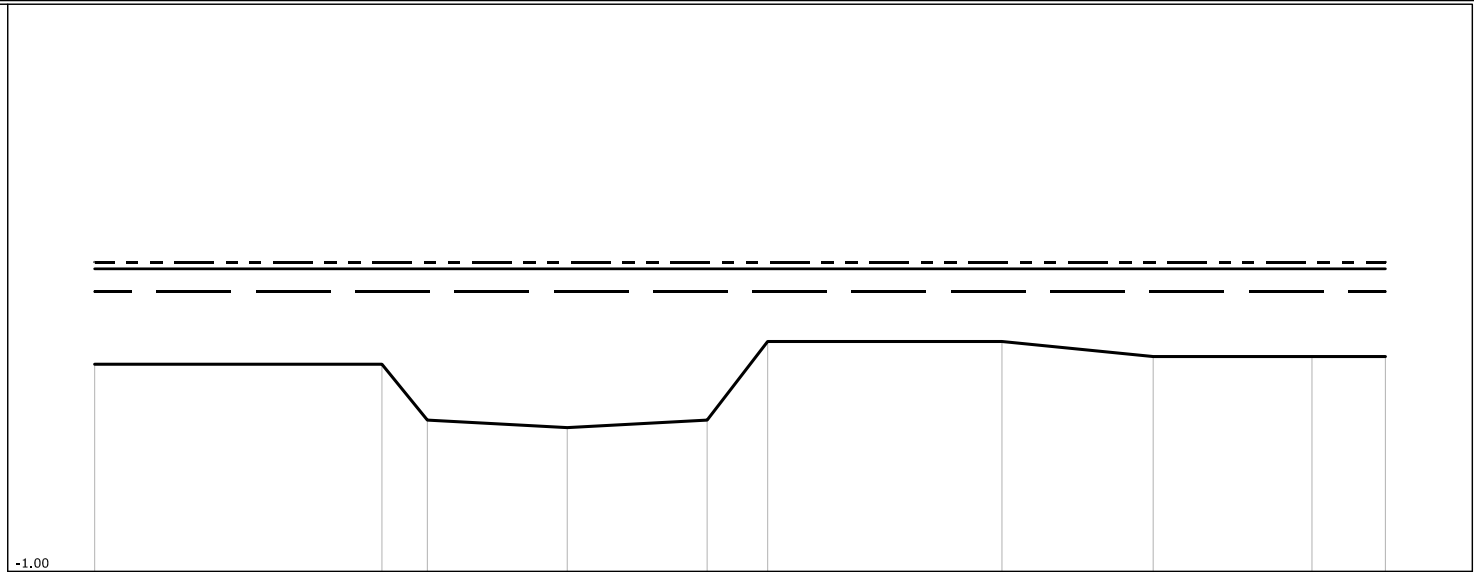

PUNTI	1	2	3	4	5	6	7	8	9	10
QUOTE [m s.l.m.]	1.74	1.74	1.00	0.90	1.00	2.04	2.04	1.84	1.84	1.84
DISTANZE PROGRESSIVE [m]	0.00	3.80	4.40	6.25	8.10	8.90	12.00	14.00	16.10	17.07
DISTANZE PARZIALI [m]		3.80	0.60	1.85	1.85	0.80	3.10	2.00	2.10	0.97

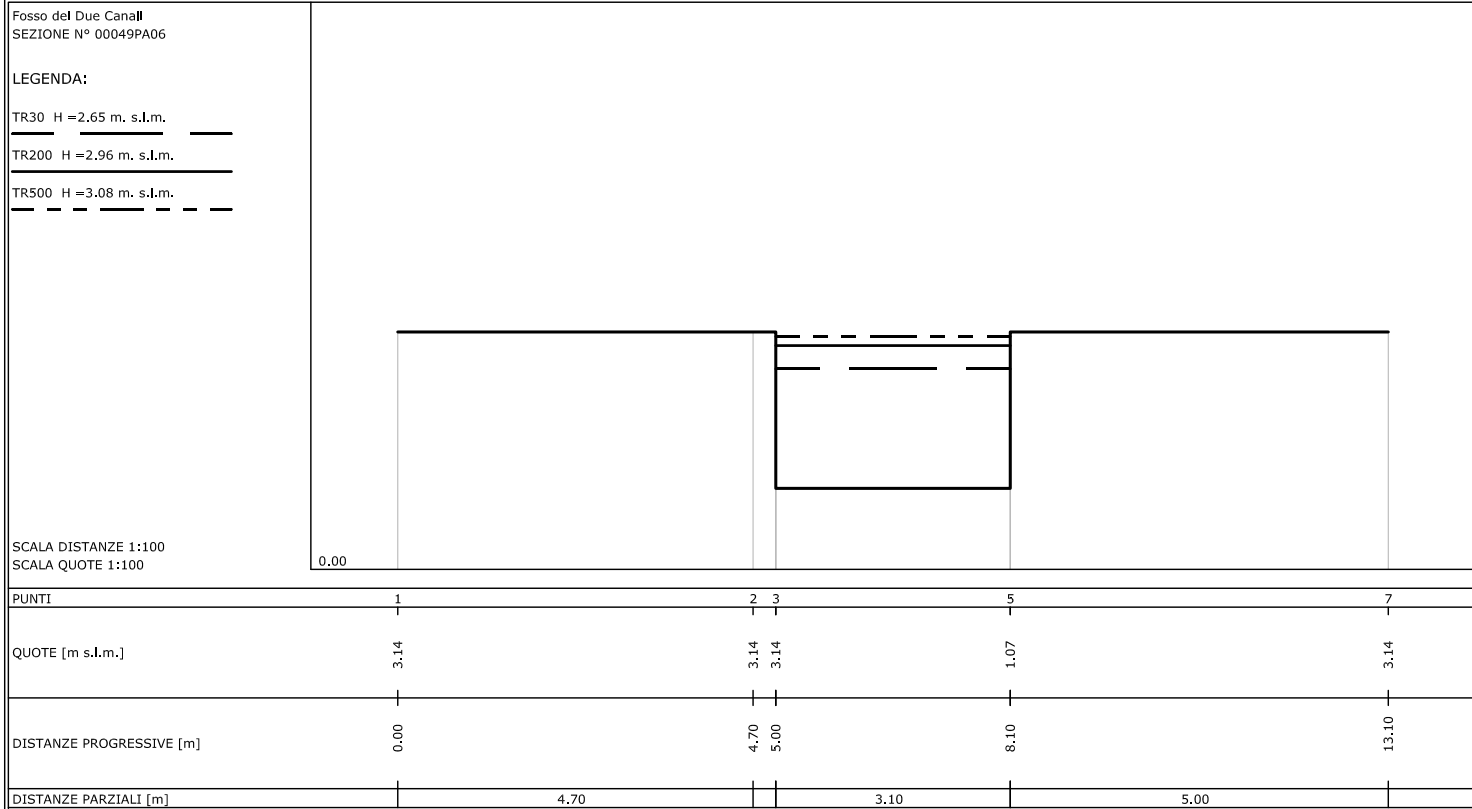

Fosso del Due Canali  
 SEZIONE N° 00049PB06

LEGENDA:

TR30 H =2.64 m. s.l.m. 

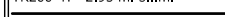
TR200 H =2.95 m. s.l.m. 

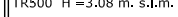
TR500 H =3.08 m. s.l.m. 

SCALA DISTANZE 1:100  
 SCALA QUOTE 1:100

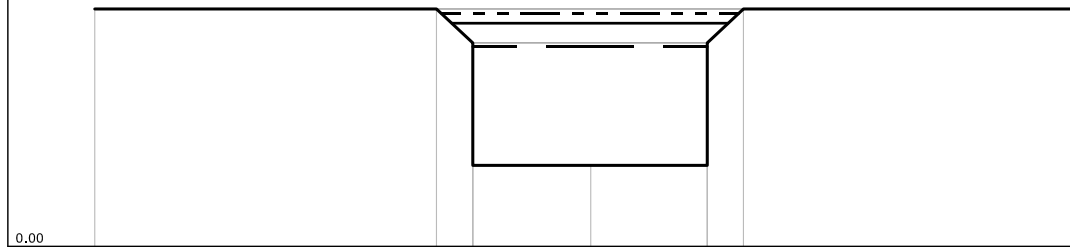

PUNTI	1	2	3	5	6	8	9
QUOTE [m s.l.m.]	3.14	3.14	2.69	1.07	1.07	3.14	3.14
DISTANZE PROGRESSIVE [m]	0.00	4.52	5.00	6.56	8.10	8.58	13.10
DISTANZE PARZIALI [m]		4.52	0.48	1.56	1.54		4.52

Fosso del Due Canali  
 SEZIONE N° 00049PC06

LEGENDA:

TR30 H =2.61 m. s.l.m. \_\_\_\_\_

TR200 H =2.92 m. s.l.m. \_\_\_\_\_

TR500 H =3.05 m. s.l.m. - - - - -

SCALA DISTANZE 1:100  
 SCALA QUOTE 1:100

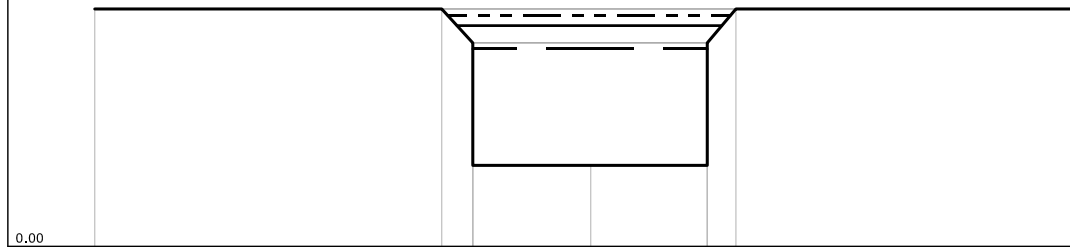

PUNTI	1	2	3	5	6	8	9
QUOTE [m s.l.m.]	3.14	3.14	2.69	1.07	1.07	3.14	3.14
DISTANZE PROGRESSIVE [m]	0.00	4.59	5.00	6.56	8.10	8.48	13.10
DISTANZE PARZIALI [m]		4.59		1.56	1.54		4.62



Fosso del Due Canali  
 SEZIONE N° 00049PD06

LEGENDA:

TR30 H =2.61 m. s.l.m. ———

TR200 H =2.92 m. s.l.m. ———

TR500 H =3.05 m. s.l.m. - - - - -

SCALA DISTANZE 1:100  
 SCALA QUOTE 1:100

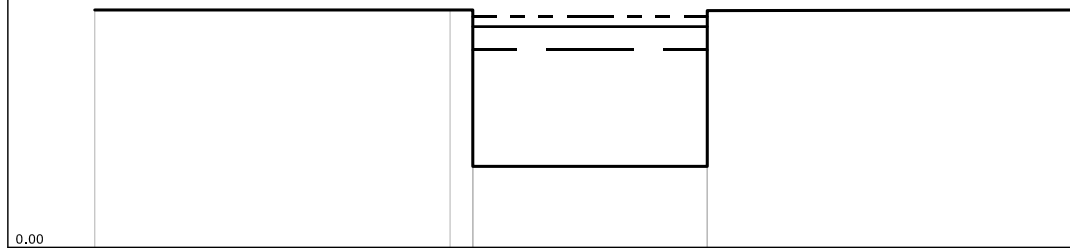



PUNTI	1	2	3	5	7
QUOTE [m s.l.m.]	3.14	3.14	3.14	1.07	3.14
DISTANZE PROGRESSIVE [m]	0.00	4.70	5.00	8.10	13.10
DISTANZE PARZIALI [m]		4.70		3.10	5.00

Fosso def Due Canali  
 SEZIONE N° 00047\_\_06

LEGENDA:

TR30 H =2.63 m. s.l.m. 

TR200 H =2.94 m. s.l.m. 

TR500 H =3.06 m. s.l.m. 

SCALA DISTANZE 1:100  
 SCALA QUOTE 1:100

-1.00

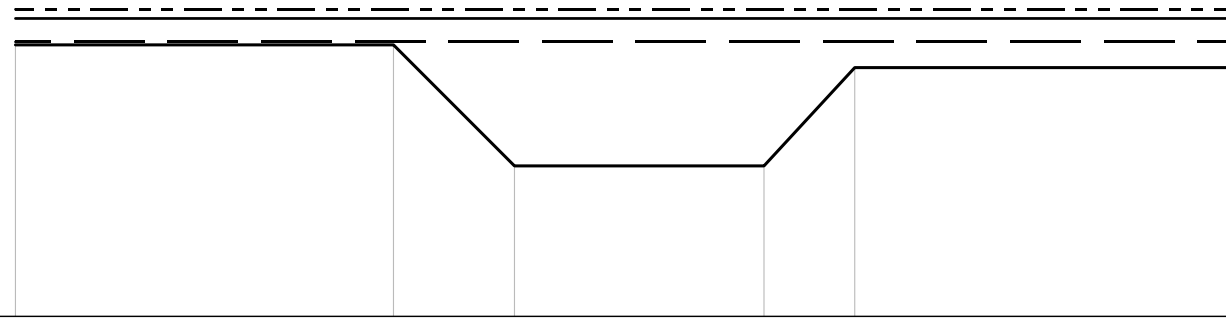



PUNTI	1	2	3	4	5	6
QUOTE [m s.l.m.]	2.59	2.59	0.99	0.99	2.29	2.29
DISTANZE PROGRESSIVE [m]	0.00	5.00	6.60	9.90	11.10	16.10
DISTANZE PARZIALI [m]		5.00	1.60	3.30	1.20	5.00

Fosso del Due Canali  
 SEZIONE N° 00043\_\_06

LEGENDA:

TR30 H = 2.63 m. s.l.m. 

TR200 H = 2.93 m. s.l.m. 

TR500 H = 3.06 m. s.l.m. 

SCALA DISTANZE 1:100  
 SCALA QUOTE 1:100

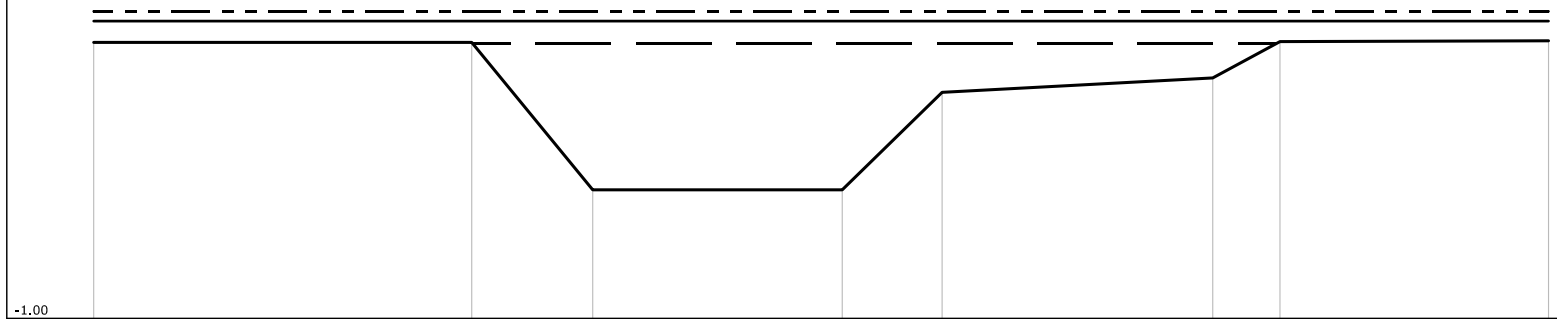

PUNTI	1	2	3	4	5	6	7	8
QUOTE [m s.l.m.]	2.65	2.65	0.70	0.70	1.99	2.18	2.66	2.67
DISTANZE PROGRESSIVE [m]	0.00	5.00	6.60	9.90	11.22	14.80	15.69	19.24
DISTANZE PARZIALI [m]		5.00	1.60	3.30	1.32	3.58	0.89	3.55

Fosso del Due Canali  
 SEZIONE N° 00038\_\_06

LEGENDA:

TR30 H =2.61 m. s.l.m. ————

TR200 H =2.93 m. s.l.m. ————

TR500 H =3.05 m. s.l.m. - - - - -

SCALA DISTANZE 1:100  
 SCALA QUOTE 1:100

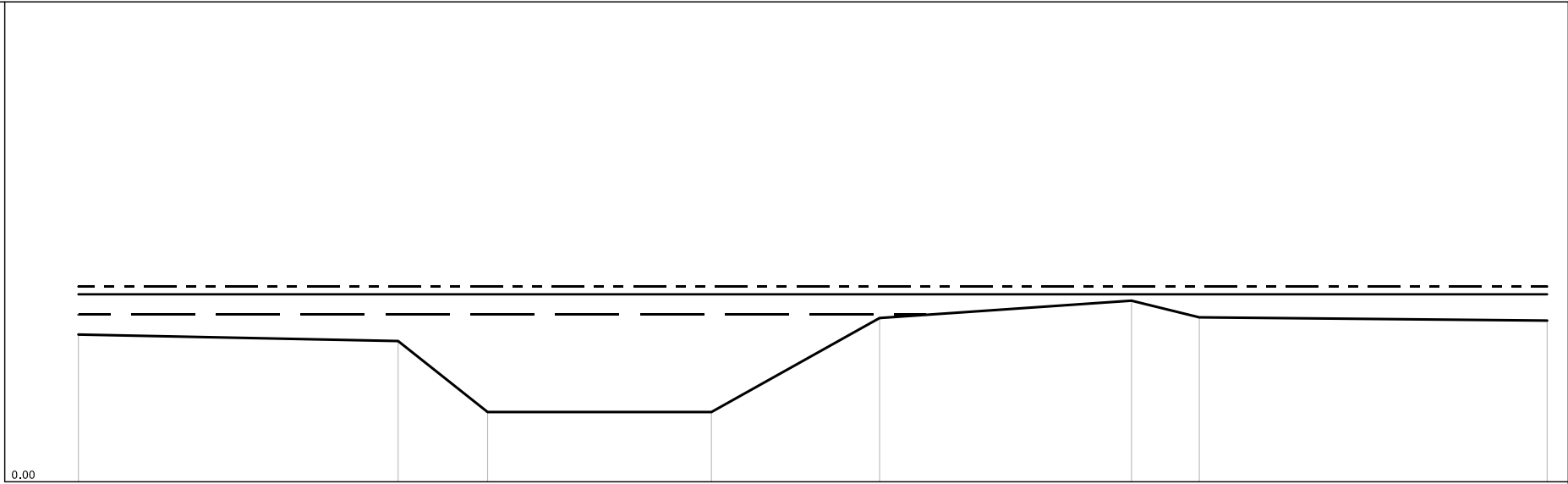

PUNTI	1	2	3	4	5	6	7	8
QUOTE [m s.l.m.]	2.30	2.20	1.09	1.09	2.56	2.83	2.57	2.52
DISTANZE PROGRESSIVE [m]	0.00	5.00	6.40	9.90	12.53	16.47	17.53	22.97
DISTANZE PARZIALI [m]		5.00	1.40	3.50	2.63	3.94	1.06	5.44

Fosso del Due Canal  
 SEZIONE N° 00034\_\_06

LEGENDA:

TR30 H =2.55 m. s.l.m. ———

TR200 H =2.86 m. s.l.m. ———

TR500 H =3.01 m. s.l.m. - - - - -

SCALA DISTANZE 1:100  
 SCALA QUOTE 1:100

-1.00

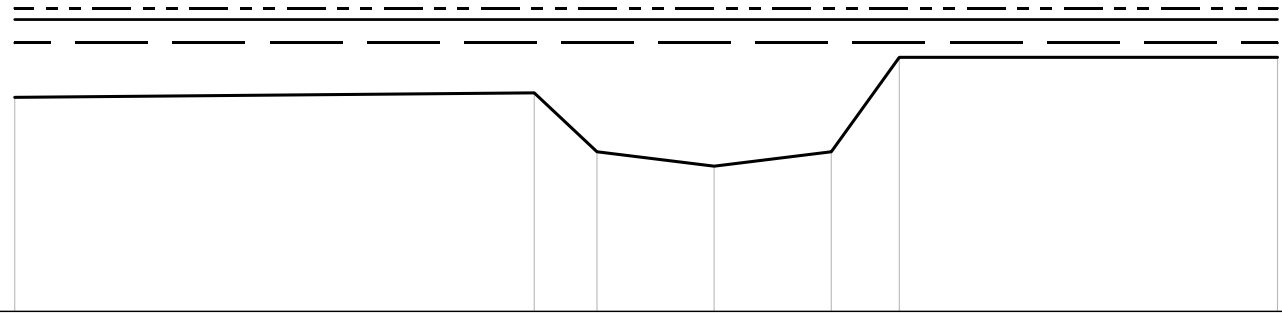



PUNTI	1	2	3	4	5	6	7
QUOTE [m s.l.m.]	1.83	1.89	1.11	0.92	1.11	2.36	2.36
DISTANZE PROGRESSIVE [m]	0.00	6.87	7.70	9.25	10.80	11.70	16.70
DISTANZE PARZIALI [m]		6.87	0.83	1.55	1.55	0.90	5.00

Fosso del Due Canali  
 SEZIONE N° 00033PA06

LEGENDA:

TR30 H = 2.56 m. s.l.m. 

TR200 H = 2.86 m. s.l.m. 

TR500 H = 3.01 m. s.l.m. 

SCALA DISTANZE 1:100  
 SCALA QUOTE 1:100

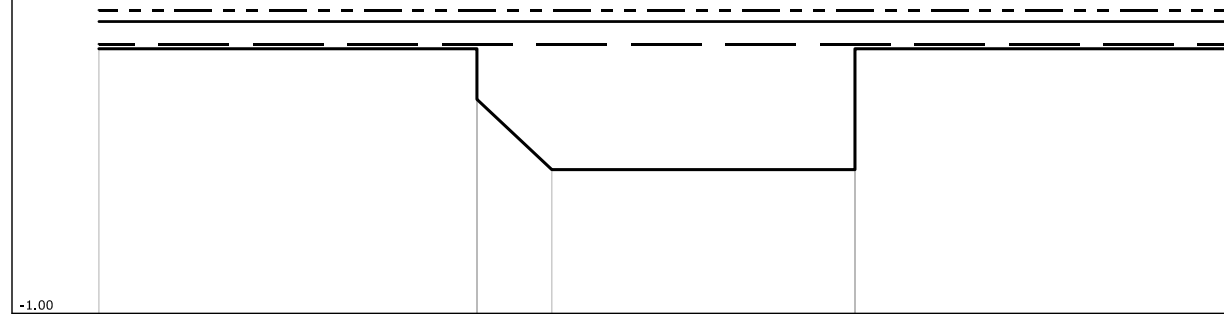



PUNTI	1	2	4	5	7
QUOTE [m s.l.m.]	2.50	2.50	0.90	0.90	2.50
DISTANZE PROGRESSIVE [m]	0.00	5.00	5.99	10.00	15.00
DISTANZE PARZIALI [m]		5.00	0.99	4.01	5.00

Fosso del Due Canali  
 SEZIONE N° 00033PB06

LEGENDA:

TR30 H = 2.56 m. s.l.m. 

TR200 H = 2.86 m. s.l.m. 

TR500 H = 3.00 m. s.l.m. 

SCALA DISTANZE 1:100  
 SCALA QUOTE 1:100

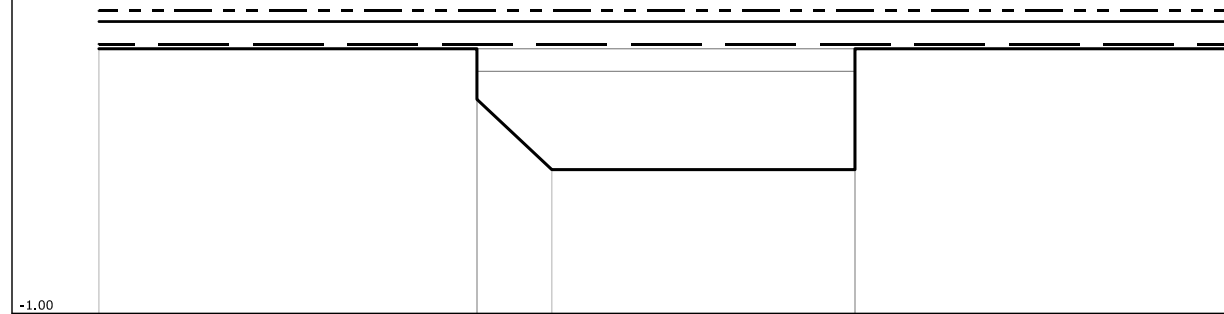



PUNTI	1	2	5	6	9
QUOTE [m s.l.m.]	2.50	2.50	0.90	0.90	2.50
DISTANZE PROGRESSIVE [m]	0.00	5.00	5.99	10.00	15.00
DISTANZE PARZIALI [m]		5.00	0.99	4.01	5.00

Fosso del Due Canali  
 SEZIONE N° 00033PC06

LEGENDA:

TR30 H = 2.52 m. s.l.m. 

TR200 H = 2.82 m. s.l.m. 

TR500 H = 2.97 m. s.l.m. 

SCALA DISTANZE 1:100  
 SCALA QUOTE 1:100

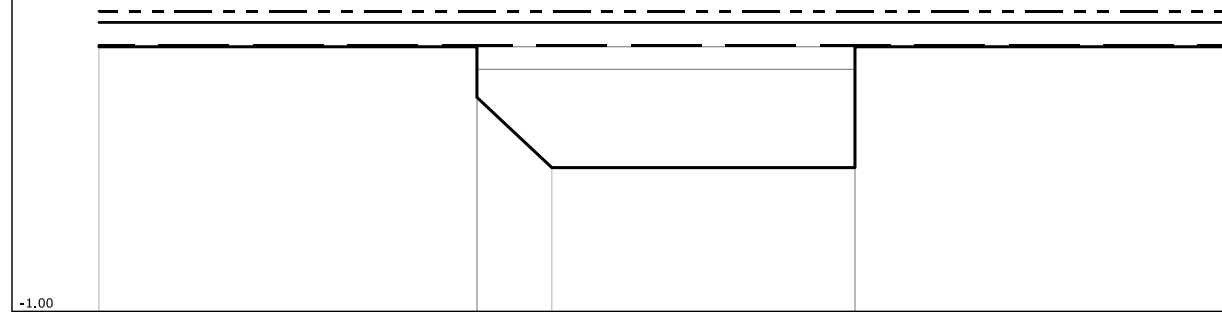



PUNTI	1	2	5	6	9
QUOTE [m s.l.m.]	2.50	2.50	0.90	0.90	2.50
DISTANZE PROGRESSIVE [m]	0.00	5.00	5.99	10.00	15.00
DISTANZE PARZIALI [m]		5.00	0.99	4.01	5.00



Fosso del Due Canali  
 SEZIONE N° 00033PD06

LEGENDA:

TR30 H = 2.51 m. s.l.m. 

TR200 H = 2.81 m. s.l.m. 

TR500 H = 2.95 m. s.l.m. 

SCALA DISTANZE 1:100  
 SCALA QUOTE 1:100

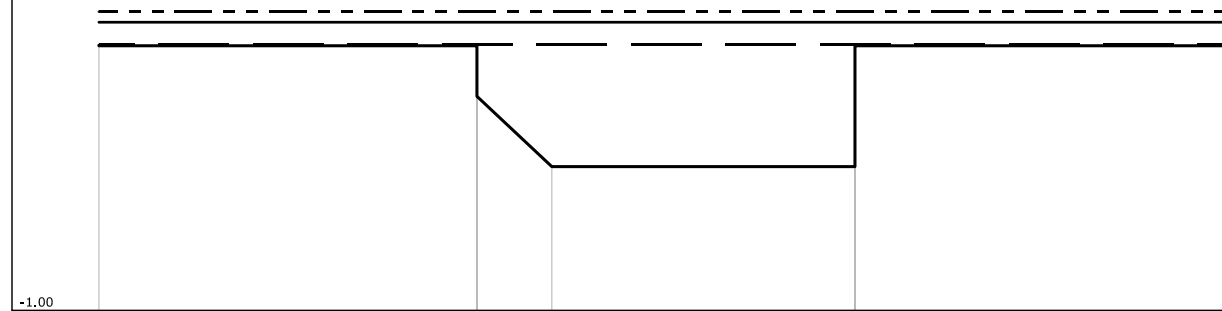

PUNTI	1	2	4	5	7
QUOTE [m s.l.m.]	2.50	2.50	0.90	0.90	2.50
DISTANZE PROGRESSIVE [m]	0.00	5.00	5.99	10.00	15.00
DISTANZE PARZIALI [m]		5.00	0.99	4.01	5.00

Fosso del Due Canali  
 SEZIONE N° 00030PA06

LEGENDA:

TR30 H = 2.45 m. s.l.m. \_\_\_\_\_

TR200 H = 2.78 m. s.l.m. \_\_\_\_\_

TR500 H = 2.91 m. s.l.m. - - - - -

SCALA DISTANZE 1:100  
 SCALA QUOTE 1:100

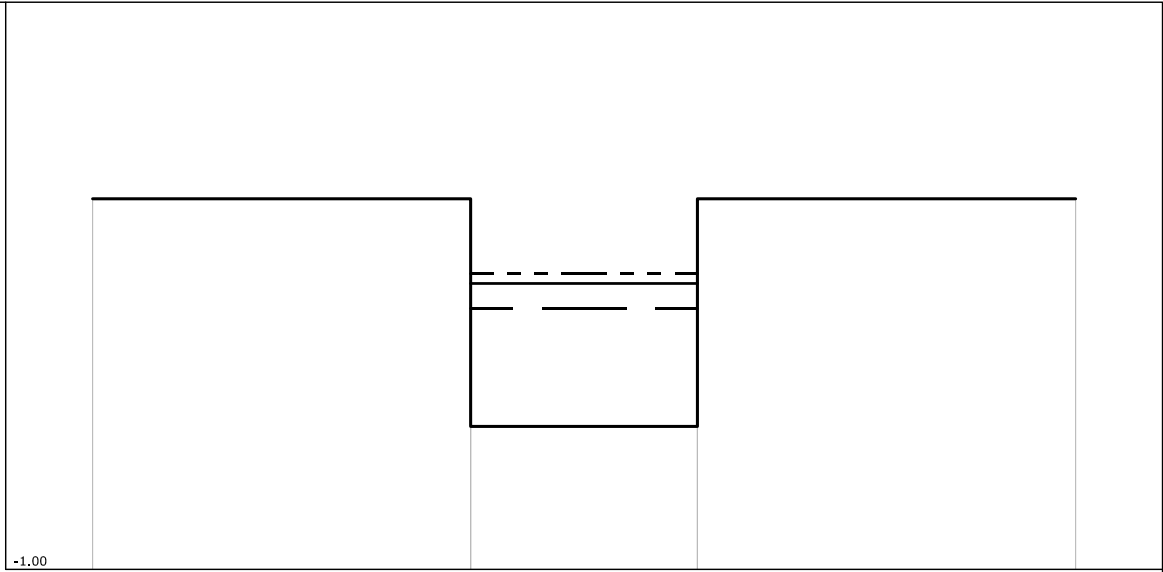

PUNTI	1	2	4	6
QUOTE [m s.l.m.]	3.90	3.90	0.89	3.90
DISTANZE PROGRESSIVE [m]	0.00	5.00	8.00	13.00
DISTANZE PARZIALI [m]		5.00	3.00	5.00

Fosso del Due Canali  
 SEZIONE N° 00030PB06

LEGENDA:

TR30 H = 2.45 m. s.l.m. ———

TR200 H = 2.78 m. s.l.m. ———

TR500 H = 2.91 m. s.l.m. - - - - -

SCALA DISTANZE 1:100  
 SCALA QUOTE 1:100

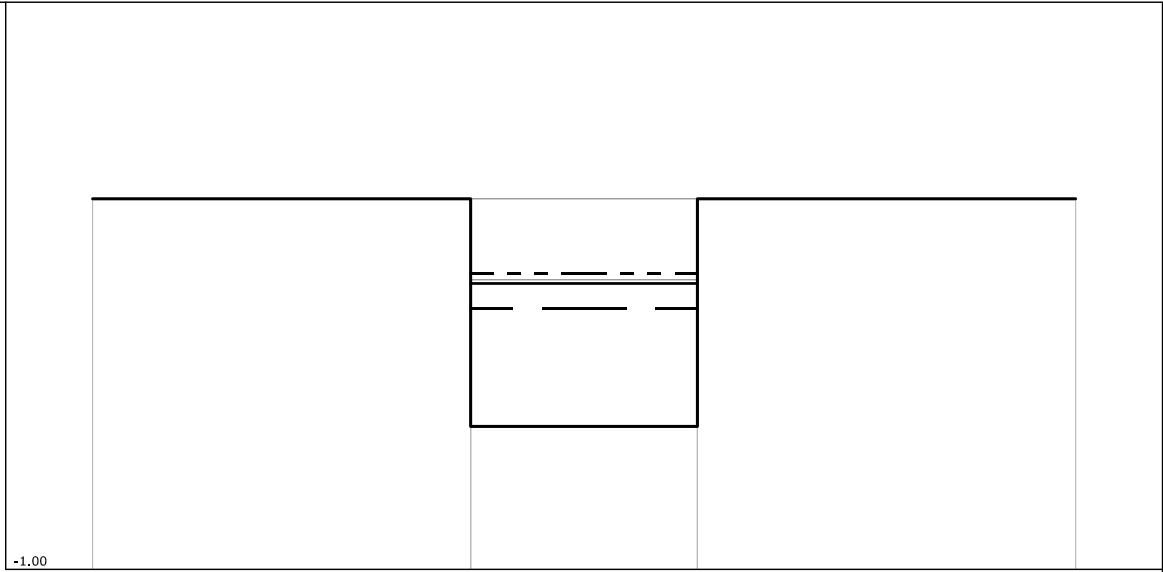

PUNTI	1	2	5	8
QUOTE [m s.l.m.]	3.90	3.90	0.89	3.90
DISTANZE PROGRESSIVE [m]	0.00	5.00	8.00	13.00
DISTANZE PARZIALI [m]		5.00	3.00	5.00

Fosso del Due Canali  
 SEZIONE N° 00030PC06

LEGENDA:

TR30 H = 2.40 m. s.l.m. 

TR200 H = 2.75 m. s.l.m. 

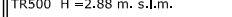
TR500 H = 2.88 m. s.l.m. 

SCALA DISTANZE 1:100  
 SCALA QUOTE 1:100

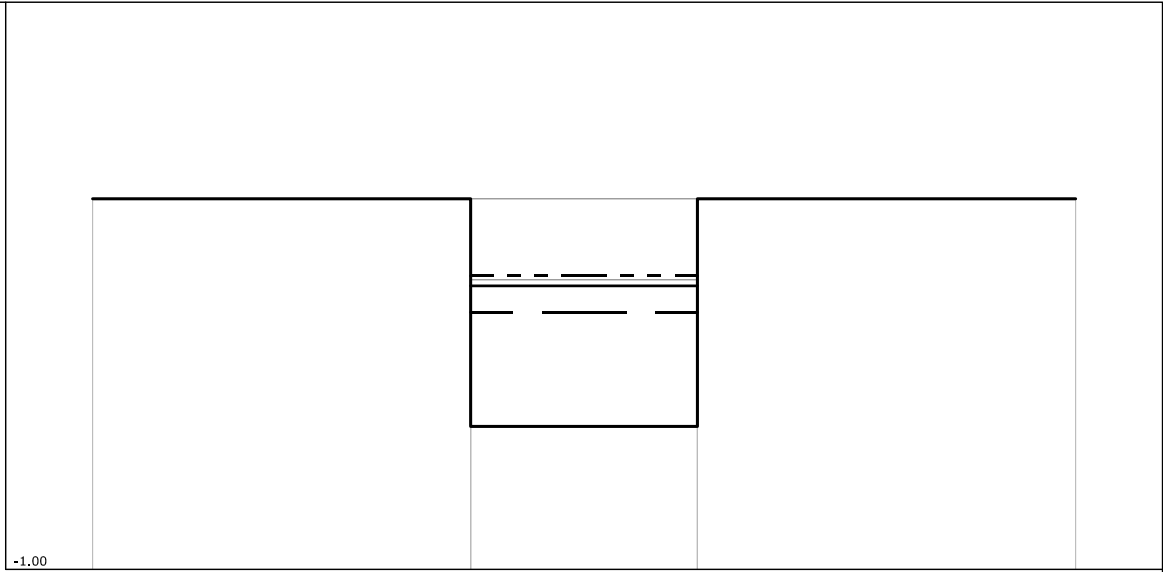

PUNTI	1	2	5	8
QUOTE [m s.l.m.]	3.90	3.90	0.89	3.90
DISTANZE PROGRESSIVE [m]	0.00	5.00	8.00	13.00
DISTANZE PARZIALI [m]		5.00	3.00	5.00

Fosso del Due Canali  
 SEZIONE N° 00030PD06

LEGENDA:

TR30 H = 2.40 m. s.l.m. 

TR200 H = 2.75 m. s.l.m. 

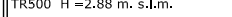
TR500 H = 2.88 m. s.l.m. 

SCALA DISTANZE 1:100  
 SCALA QUOTE 1:100

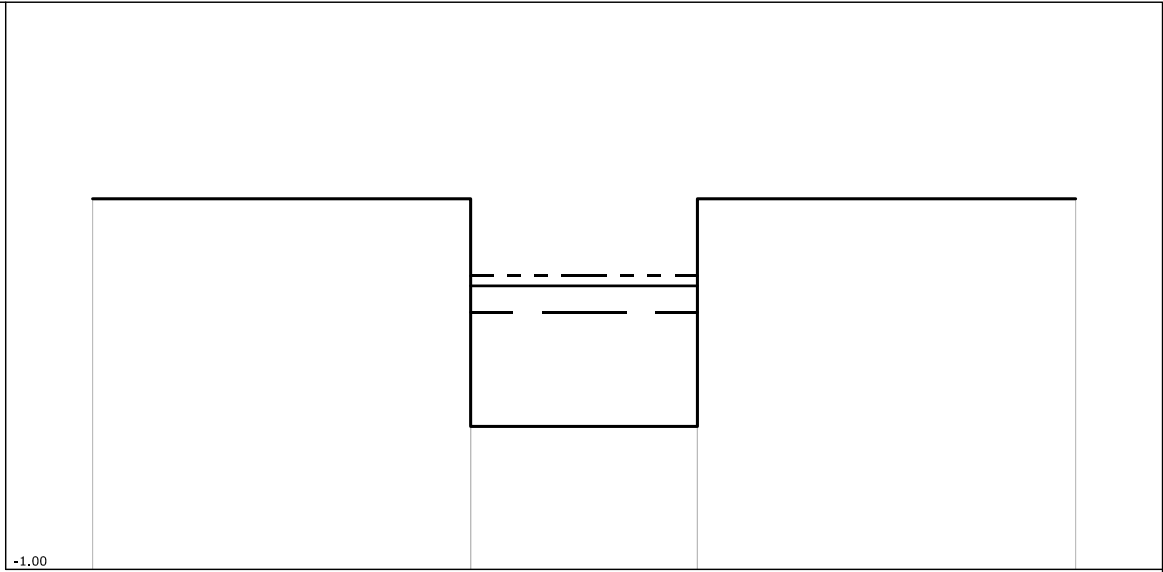

PUNTI	1	2	4	6
QUOTE [m s.l.m.]	3.90	3.90	0.89	3.90
DISTANZE PROGRESSIVE [m]	0.00	5.00	8.00	13.00
DISTANZE PARZIALI [m]		5.00	3.00	5.00

Fosso del Due Canali  
 SEZIONE N° 00028\_\_06

LEGENDA:

- TR30 H =2.38 m. s.l.m.
- TR200 H =2.75 m. s.l.m.
- TR500 H =2.88 m. s.l.m.

SCALA DISTANZE 1:100  
 SCALA QUOTE 1:100

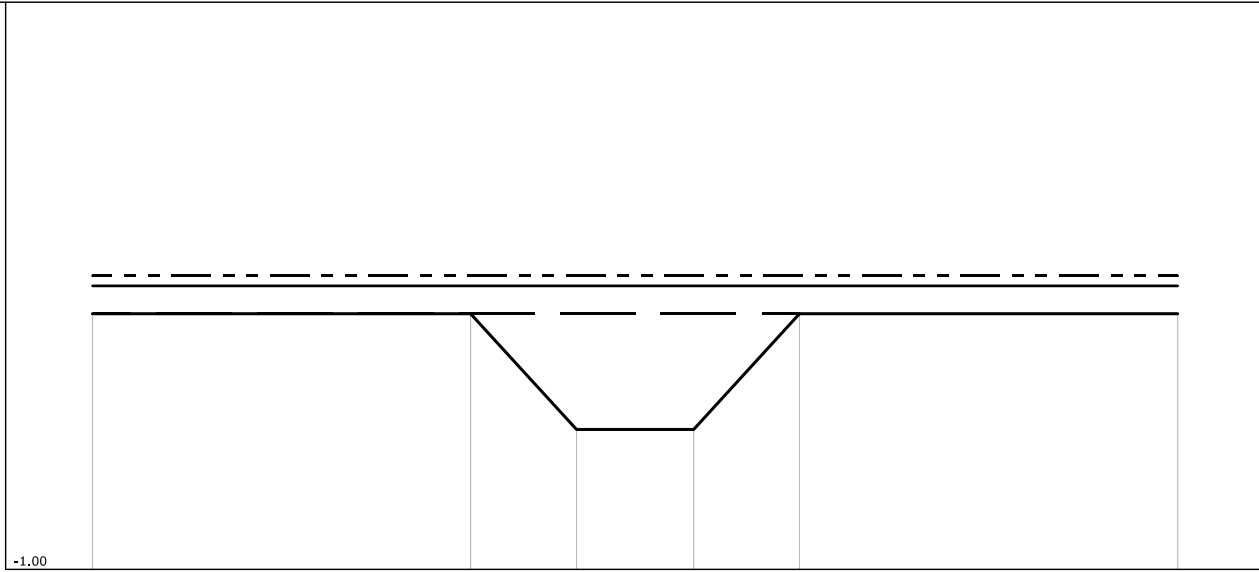

PUNTI	1	2	3	4	5	6
QUOTE [m s.l.m.]	2.38	2.38	0.85	0.85	2.38	2.38
DISTANZE PROGRESSIVE [m]	0.00	5.00	6.40	7.95	9.35	14.35
DISTANZE PARZIALI [m]		5.00	1.40	1.55	1.40	5.00

Fosso del Due Canali  
 SEZIONE N° 00027PA06

LEGENDA:

TR30 H = 2.37 m. s.l.m. ———

TR200 H = 2.75 m. s.l.m. ———

TR500 H = 2.89 m. s.l.m. - - - - -

SCALA DISTANZE 1:100  
 SCALA QUOTE 1:100

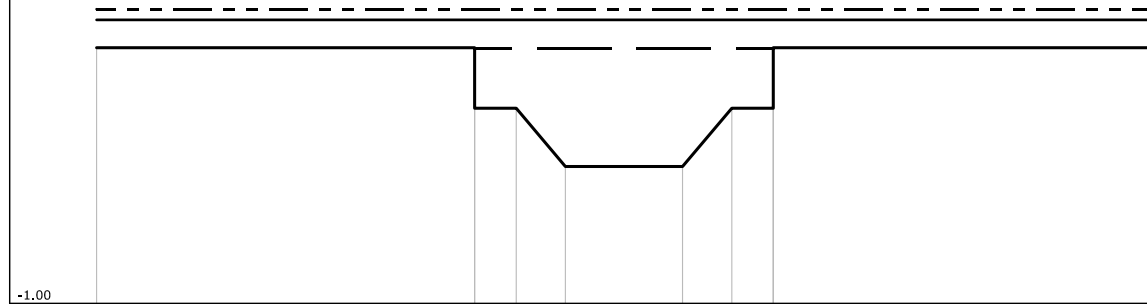

PUNTI	1	2	4	5	6	7	8	10
QUOTE [m s.l.m.]	2.38	2.38	1.58	0.81	0.81	1.58	1.58	2.38
DISTANZE PROGRESSIVE [m]	0.00	5.00	5.55	6.20	7.75	8.40	8.95	13.95
DISTANZE PARZIALI [m]		5.00	0.55	0.65	1.55	0.65	0.55	5.00

Fosso del Due Canali  
 SEZIONE N° 00027PB06

LEGENDA:

TR30 H =2.37 m. s.l.m. ———

TR200 H =2.75 m. s.l.m. ———

TR500 H =2.89 m. s.l.m. - - - - -

SCALA DISTANZE 1:100  
 SCALA QUOTE 1:100

-1.00

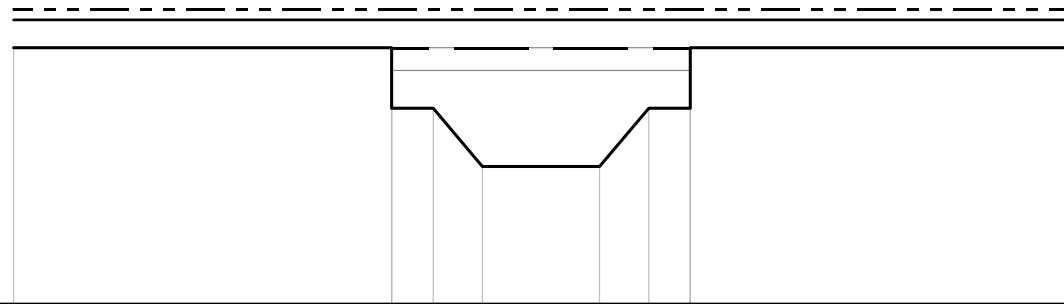

PUNTI	1	2	5	6	7	8	9	12
QUOTE [m s.l.m.]	2.38	2.38	1.58	0.81	0.81	1.58	1.58	2.38
DISTANZE PROGRESSIVE [m]	0.00	5.00	5.55	6.20	7.75	8.40	8.95	13.95
DISTANZE PARZIALI [m]		5.00	0.55	0.65	1.55	0.65	0.55	5.00



Fosso del Due Canali  
 SEZIONE N° 00027PC06

LEGENDA:

TR30 H =2.40 m. s.l.m. ———

TR200 H =2.72 m. s.l.m. ———

TR500 H =2.85 m. s.l.m. - - - - -

SCALA DISTANZE 1:100  
 SCALA QUOTE 1:100

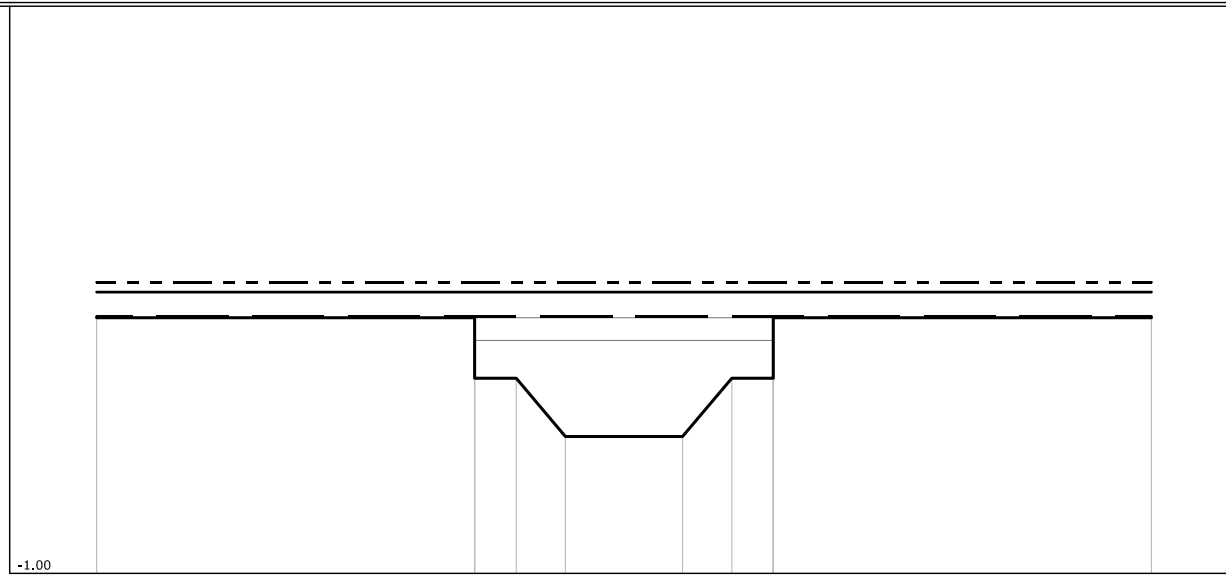

PUNTI	1	2	5	6	7	8	9	12
QUOTE [m s.l.m.]	2.38	2.38	1.58	0.81	0.81	1.58	1.58	2.38
DISTANZE PROGRESSIVE [m]	0.00	5.00	5.55	6.20	7.75	8.40	8.95	13.95
DISTANZE PARZIALI [m]		5.00	0.55	0.65	1.55	0.65	0.55	5.00

Fosso del Due Canali  
 SEZIONE N° 00027PD06

LEGENDA:

TR30 H = 2.34 m. s.l.m. ———

TR200 H = 2.72 m. s.l.m. ————

TR500 H = 2.85 m. s.l.m. - - - - -

SCALA DISTANZE 1:100  
 SCALA QUOTE 1:100

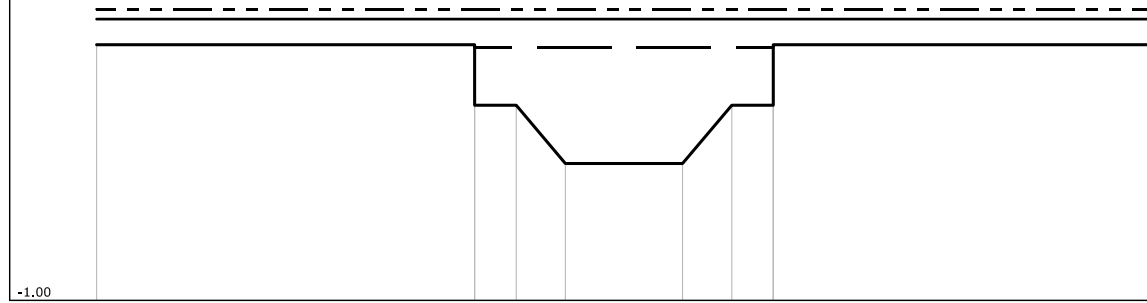

PUNTI	1	2	4	5	6	7	8	10
QUOTE [m s.l.m.]	2.38	2.38	1.58	0.81	0.81	1.58	1.58	2.38
DISTANZE PROGRESSIVE [m]	0.00	5.00	5.55	6.20	7.75	8.40	8.95	13.95
DISTANZE PARZIALI [m]		5.00	0.55	0.65	1.55	0.65	0.55	5.00

Fosso del Due Canali  
 SEZIONE N° 00025\_\_06

LEGENDA:

- TR30 H = 2.33 m. s.l.m.
- TR200 H = 2.73 m. s.l.m.
- TR500 H = 2.86 m. s.l.m.

SCALA DISTANZE 1:100  
 SCALA QUOTE 1:100

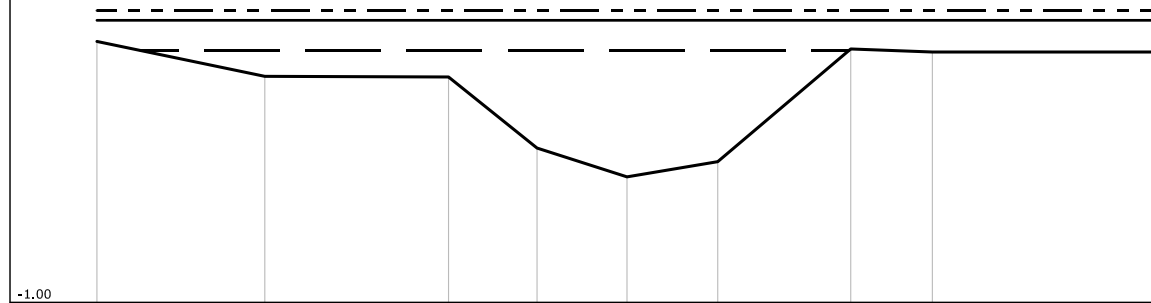

PUNTI	1	2	3	4	5	6	7	8	9
QUOTE [m s.l.m.]	2.45	1.99	1.98	1.04	0.66	0.86	2.35	2.31	2.31
DISTANZE PROGRESSIVE [m]	0.00	2.22	4.65	5.82	7.01	8.21	9.97	11.05	14.05
DISTANZE PARZIALI [m]		2.22	2.43	1.17	1.19	1.20	1.76	1.08	3.00

Fosso del Due Canali  
 SEZIONE N° 00022\_\_06

LEGENDA:

TR30 H = 2.33 m. s.l.m. ————

TR200 H = 2.73 m. s.l.m. ————

TR500 H = 2.87 m. s.l.m. - - - - -

SCALA DISTANZE 1:100  
 SCALA QUOTE 1:100

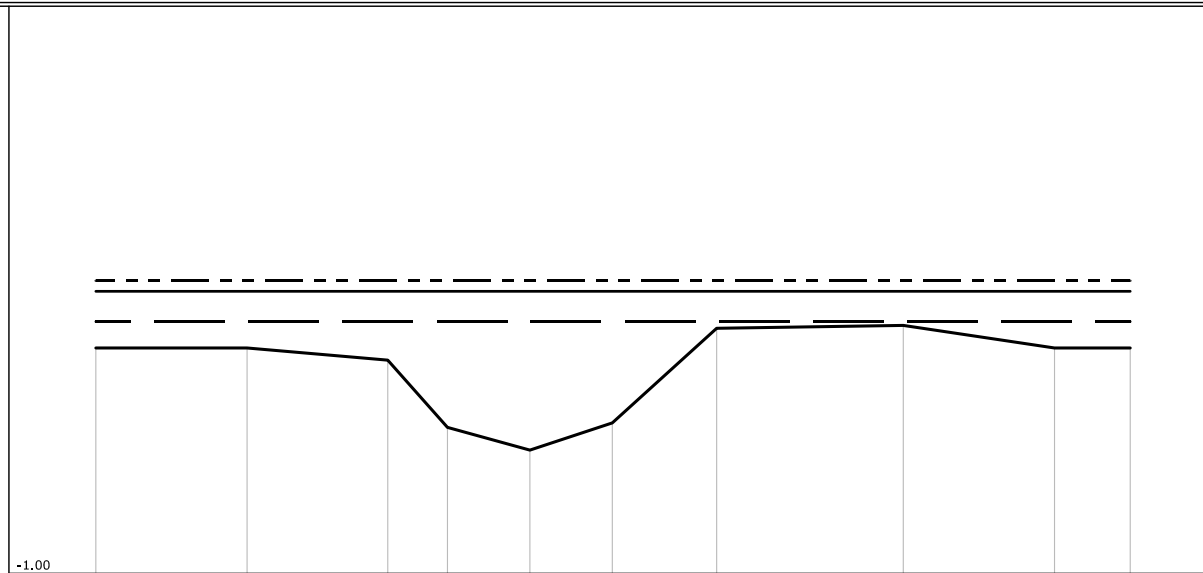

PUNTI	1	2	3	4	5	6	7	8	9	10
QUOTE [m s.l.m.]	1.98	1.98	1.82	0.93	0.63	0.99	2.24	2.28	1.98	1.98
DISTANZE PROGRESSIVE [m]	0.00	2.00	3.86	4.65	5.74	6.83	8.21	10.68	12.68	13.68
DISTANZE PARZIALI [m]		2.00	1.86	0.79	1.09	1.09	1.38	2.47	2.00	1.00

Fosso del Due Canali  
 SEZIONE N° 00019\_\_06

LEGENDA:

- TR30 H = 2.33 m. s.l.m.
- TR200 H = 2.73 m. s.l.m.
- TR500 H = 2.87 m. s.l.m.

SCALA DISTANZE 1:100  
 SCALA QUOTE 1:100

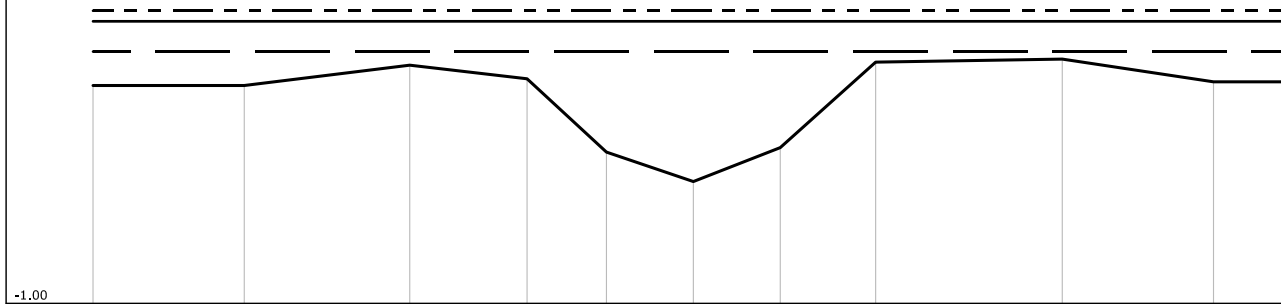

PUNTI	1	2	3	4	5	6	7	8	9	10	11
QUOTE [m s.l.m.]	1.88	1.88	2.15	1.97	1.00	0.61	1.06	2.19	2.23	1.93	1.93
DISTANZE PROGRESSIVE [m]	0.00	2.00	4.19	5.74	6.79	7.94	9.09	10.35	12.82	14.82	15.82
DISTANZE PARZIALI [m]		2.00	2.19	1.55	1.05	1.15	1.15	1.26	2.47	2.00	1.00

Fosso del Due Canali  
 SEZIONE N° 00013\_\_06

LEGENDA:

TR30 H = 2.32 m. s.l.m. ———

TR200 H = 2.72 m. s.l.m. ———

TR500 H = 2.86 m. s.l.m. - - - - -

SCALA DISTANZE 1:100  
 SCALA QUOTE 1:100

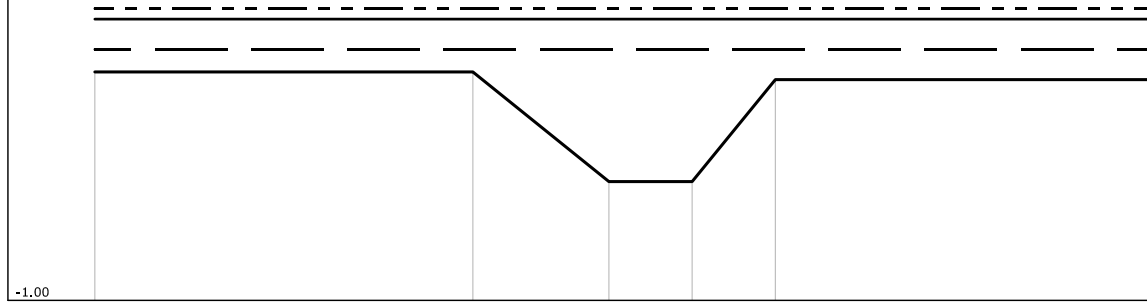

PUNTI	1	2	3	4	5	6
QUOTE [m s.l.m.]	2.02	2.02	0.57	0.57	1.92	1.92
DISTANZE PROGRESSIVE [m]	0.00	5.00	6.80	7.90	9.00	14.00
DISTANZE PARZIALI [m]		5.00	1.80	1.10	1.10	5.00

Fosso del Due Canali  
 SEZIONE N° 00007\_\_06

LEGENDA:

- TR30 H = 2.33 m. s.l.m.
- TR200 H = 2.72 m. s.l.m.
- TR500 H = 2.86 m. s.l.m.

SCALA DISTANZE 1:100  
 SCALA QUOTE 1:100

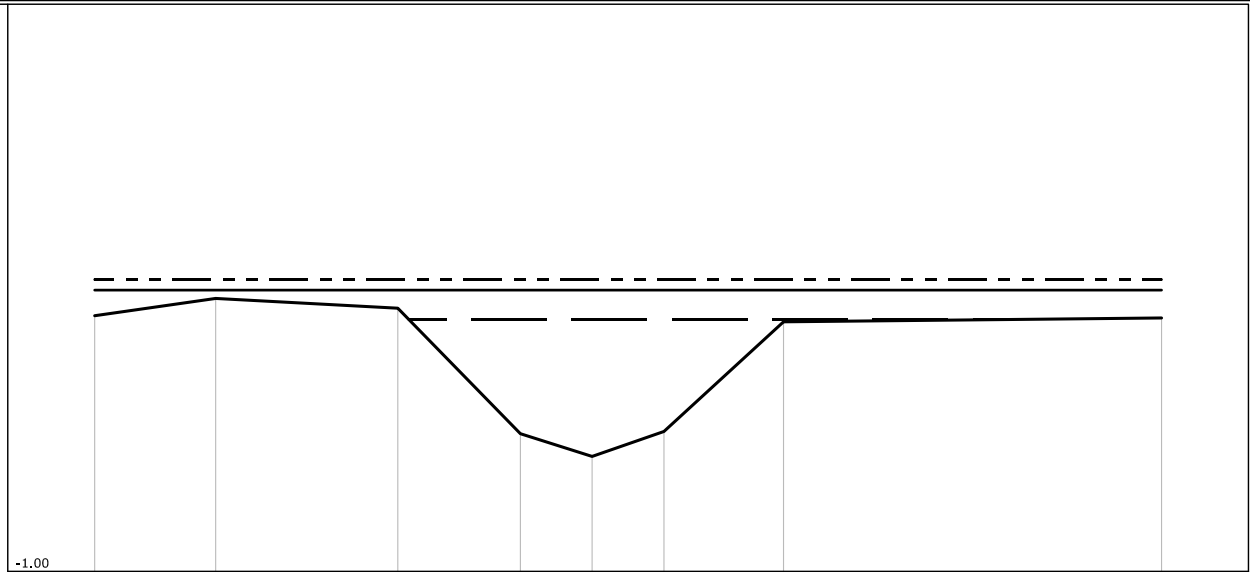

PUNTI	1	2	3	4	5	6	7	8
QUOTE [m s.l.m.]	2.38	2.61	2.48	0.82	0.52	0.85	2.30	2.35
DISTANZE PROGRESSIVE [m]	0.00	1.60	4.01	5.63	6.58	7.53	9.11	14.11
DISTANZE PARZIALI [m]		1.60	2.41	1.62	0.95	0.95	1.58	5.00

Fosso del Due Canali  
 SEZIONE N° 00004\_\_06

LEGENDA:

TR30 H = 2.32 m. s.l.m. ———

TR200 H = 2.71 m. s.l.m. ———

TR500 H = 2.84 m. s.l.m. - - - - -

SCALA DISTANZE 1:100  
 SCALA QUOTE 1:100

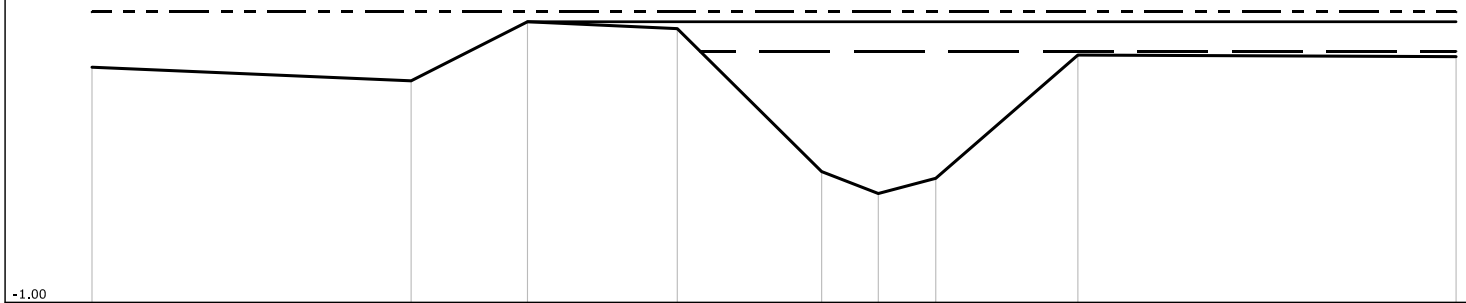

PUNTI	1	2	3	4	5	6	7	8	9
QUOTE [m s.l.m.]	2.11	1.93	2.71	2.62	0.73	0.44	0.64	2.27	2.25
DISTANZE PROGRESSIVE [m]	0.00	4.22	5.76	7.74	9.65	10.40	11.16	13.04	18.04
DISTANZE PARZIALI [m]		4.22	1.54	1.98	1.91	0.75	0.76	1.88	5.00



Fosso dei Tre Canali

Fosso del Tre Canali  
 SEZIONE N° 00200PA08

LEGENDA:

TR30 H =14.96 m. s.l.m. \_\_\_\_\_

TR200 H =15.07 m. s.l.m. \_\_\_\_\_

TR500 H =15.14 m. s.l.m. - - - - -

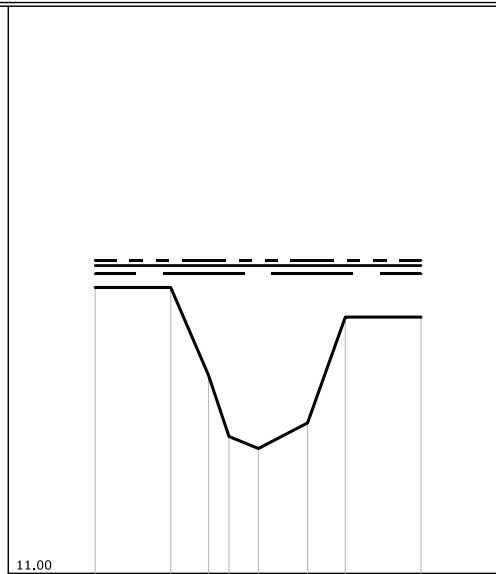

SCALA DISTANZE 1:100  
 SCALA QUOTE 1:100

PUNTI	1	2	3	4	5	6	7	8
QUOTE [m s.l.m.]	14.78	14.78	13.62	12.81	12.65	12.99	14.39	14.39
DISTANZE PROGRESSIVE [m]	0.00	1.00	1.50	1.77	2.16	2.81	3.31	4.31
DISTANZE PARZIALI [m]		1.00	0.50		0.65	0.50	1.00	

Fosso del Tre Canali  
 SEZIONE N° 00200PB08

LEGENDA:

- TR30 H =14.90 m. s.l.m.
- TR200 H =14.98 m. s.l.m.
- TR500 H =15.06 m. s.l.m.

SCALA DISTANZE 1:100  
 SCALA QUOTE 1:100

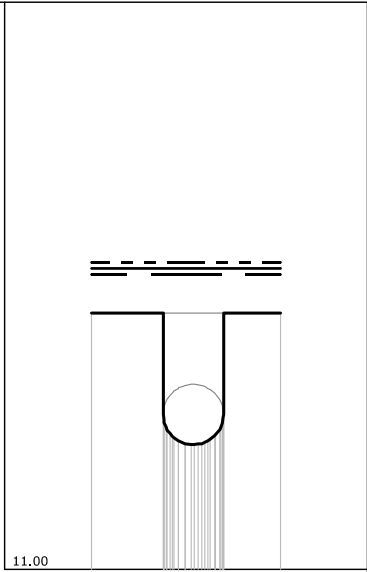

PUNTI	1	2	3	4	31
QUOTE [m s.l.m.]	14.39	14.39	14.74	12.66	14.39
DISTANZE PROGRESSIVE [m]	0.00	0.95	1.24	1.44	2.50
DISTANZE PARZIALI [m]		0.95		0.75	

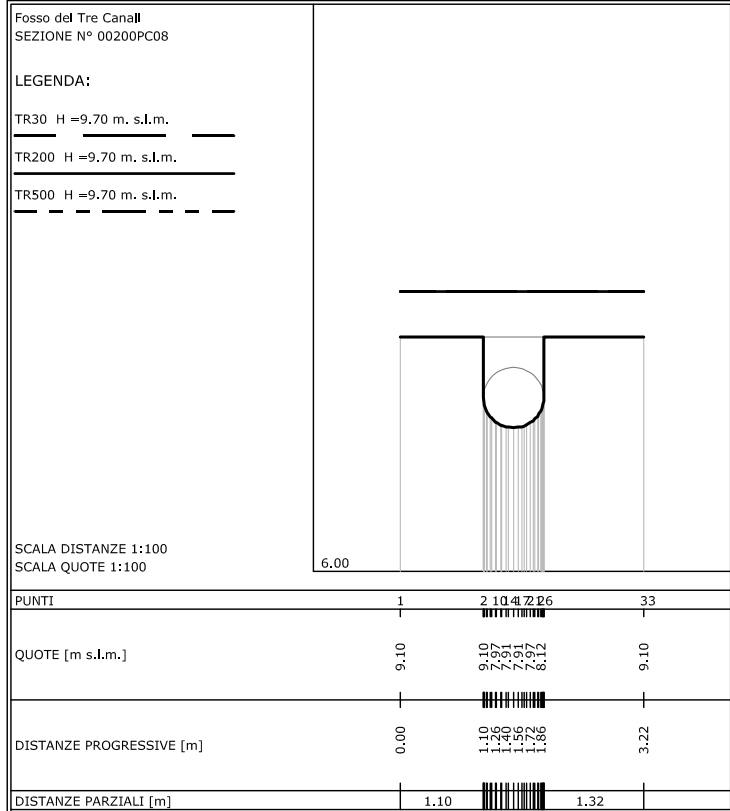

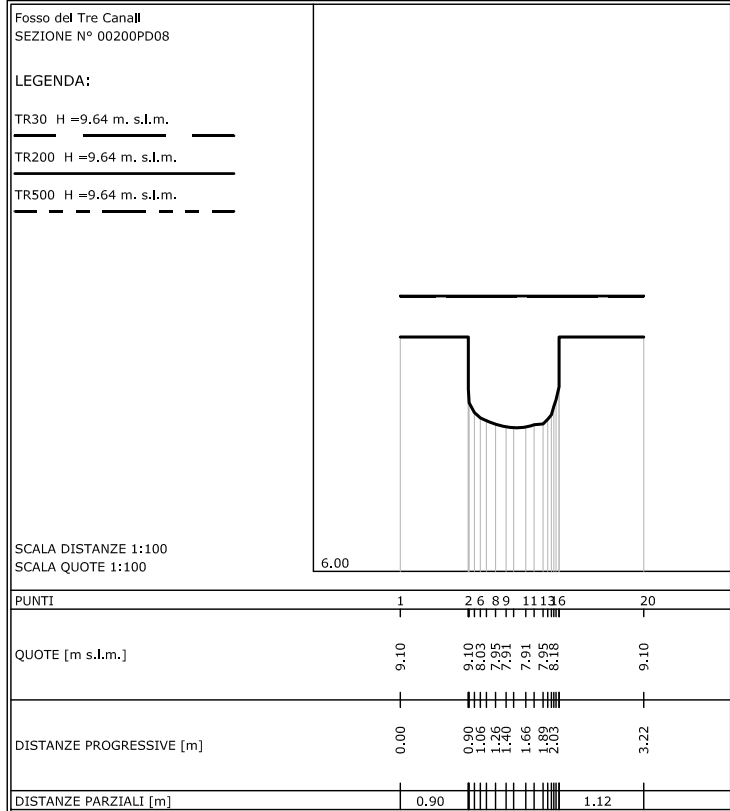

Fosso def Tre Canall  
 SEZIONE N° 00193\_\_08

LEGENDA:

TR30 H =8.01 m. s.l.m. \_\_\_\_\_

TR200 H =8.01 m. s.l.m. \_\_\_\_\_

TR500 H =8.01 m. s.l.m. - - - - -

SCALA DISTANZE 1:100  
 SCALA QUOTE 1:100

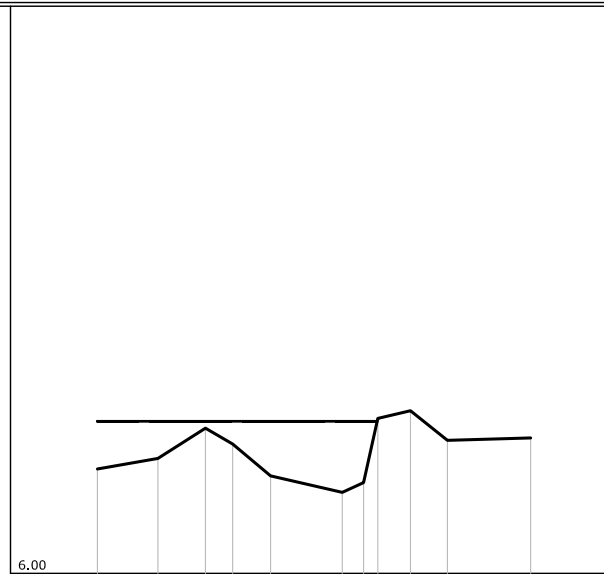

PUNTI	1	2	3	4	5	6	7	8	9	10	11
QUOTE [m s.l.m.]	7.38	7.52	7.92	7.71	7.29	7.07	7.20	8.05	8.15	7.76	7.79
DISTANZE PROGRESSIVE [m]	0.00	0.80	1.43	1.79	2.29	3.24	3.52	3.71	4.14	4.63	5.73
DISTANZE PARZIALI [m]		0.80	0.63	0.50	0.95				0.49	1.10	

Fosso del Tre Canali  
 SEZIONE N° 00191\_\_08

LEGENDA:

- TR30 H = 7.52 m. s.l.m.
- TR200 H = 7.52 m. s.l.m.
- TR500 H = 7.54 m. s.l.m.

SCALA DISTANZE 1:100  
 SCALA QUOTE 1:100

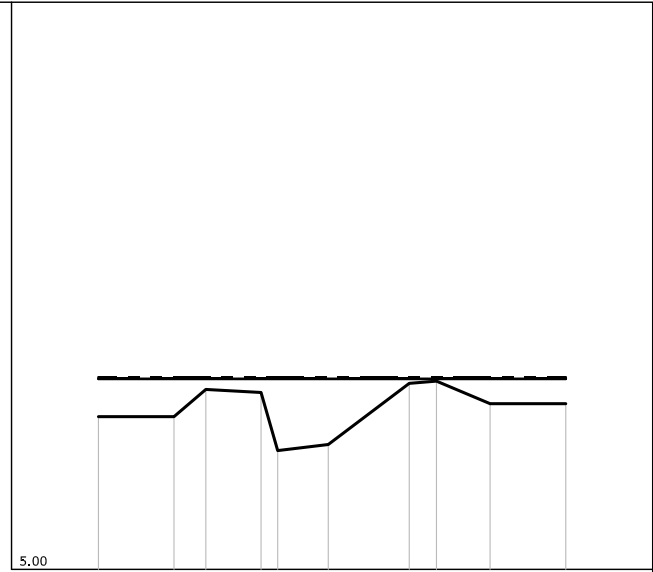

PUNTI	1	2	3	4	5	6	7	8	9	10
QUOTE [m s.l.m.]	7.02	7.02	7.38	7.34	6.57	6.65	7.46	7.49	7.19	7.19
DISTANZE PROGRESSIVE [m]	0.00	1.00	1.42	2.15	2.57	3.04	4.11	4.47	5.18	6.18
DISTANZE PARZIALI [m]		1.00	0.73	0.67	1.07	0.71	1.00			

Fosso del Tre Canali  
 SEZIONE N° 00188\_\_08

LEGENDA:

TR30 H =7.19 m. s.l.m. ———

TR200 H =7.27 m. s.l.m. ———

TR500 H =7.33 m. s.l.m. - - - - -

SCALA DISTANZE 1:100  
 SCALA QUOTE 1:100

5.00

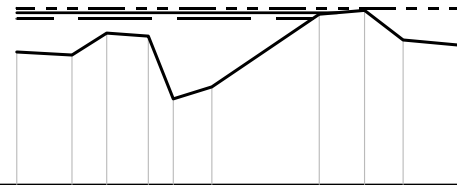



PUNTI	1	2	3	4	5	6	7	8	9	10
QUOTE [m s.l.m.]	6.75	6.71	7.00	6.96	6.13	6.29	7.25	7.30	6.91	6.83
DISTANZE PROGRESSIVE [m]	0.00	0.73	1.19	1.74	2.07	2.88	4.00	4.60	5.11	5.96
DISTANZE PARZIALI [m]		0.73	0.55	0.51	1.42	0.60	0.51	0.85		



Fosso del Tre Canali  
 SEZIONE N° 00185\_\_08

LEGENDA:

TR30 H =7.11 m. s.l.m. 

TR200 H =7.20 m. s.l.m. 

TR500 H =7.27 m. s.l.m. 

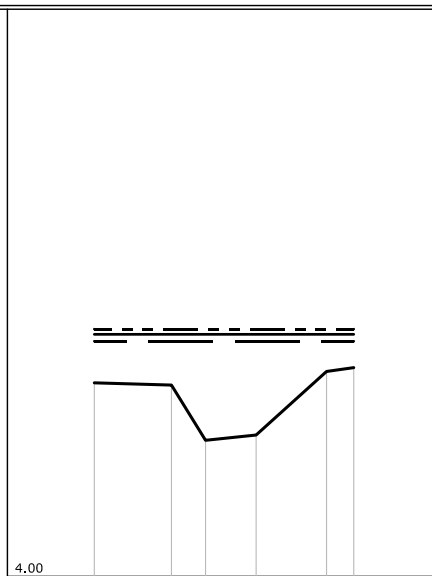

SCALA DISTANZE 1:100  
 SCALA QUOTE 1:100

PUNTI	1	2	3	4	5	6
QUOTE [m s.l.m.]	6.56	6.53	5.80	5.87	6.71	6.76
DISTANZE PROGRESSIVE [m]	0.00	1.02	1.47	2.14	3.07	3.43
DISTANZE PARZIALI [m]		1.02	0.67	0.93		

Fosso del Tre Canali  
 SEZIONE N° 00181PB08

LEGENDA:

TR30 H =7.04 m. s.l.m. ————

TR200 H =7.16 m. s.l.m. ————

TR500 H =7.28 m. s.l.m. - - - - -

SCALA DISTANZE 1:100  
 SCALA QUOTE 1:100

4.00

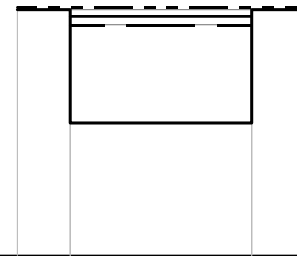

PUNTI	1	2	4	6
QUOTE [m s.l.m.]	7.25	7.25	5.75	7.25
DISTANZE PROGRESSIVE [m]	0.00	0.70	3.10	3.80
DISTANZE PARZIALI [m]	0.70	2.40	0.70	

Fosso del Tre Canali  
 SEZIONE N° 00181PC08

LEGENDA:

TR30 H =7.02 m. s.l.m. ———

TR200 H =7.13 m. s.l.m. ———

TR500 H =7.25 m. s.l.m. - - - - -

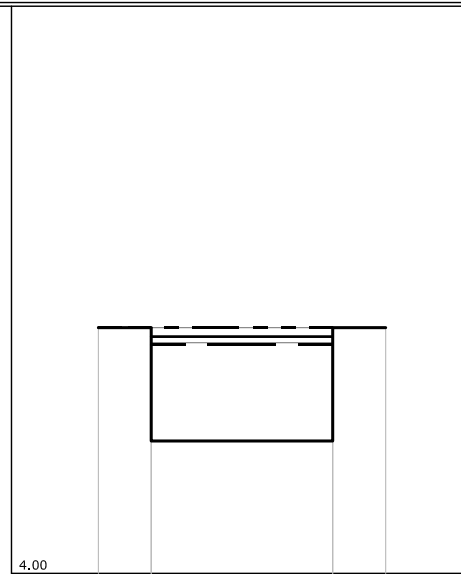

SCALA DISTANZE 1:100  
 SCALA QUOTE 1:100

PUNTI	1	2	4	6
QUOTE [m s.l.m.]	7.25	7.25	5.75	7.25
DISTANZE PROGRESSIVE [m]	0.00	0.70	3.10	3.80
DISTANZE PARZIALI [m]	0.70	2.40	0.70	

Fosso del Tre Canali  
 SEZIONE N° 00177\_\_08

LEGENDA:

TR30 H = 6.72 m. s.l.m. ———

TR200 H = 6.80 m. s.l.m. ———

TR500 H = 6.83 m. s.l.m. - - - - -

SCALA DISTANZE 1:100  
 SCALA QUOTE 1:100

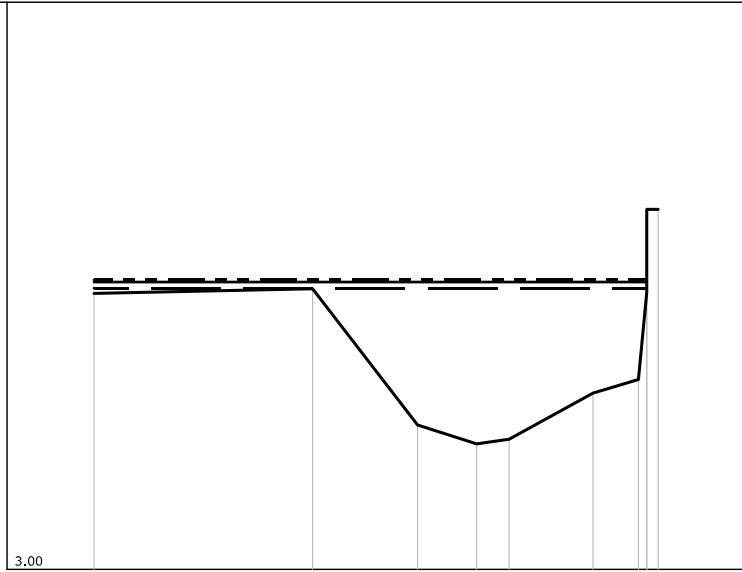

PUNTI	1	2	3	4	5	6	7	10
QUOTE [m s.l.m.]	6.65	6.71	4.91	4.66	4.72	5.33	5.51	7.76
DISTANZE PROGRESSIVE [m]	0.00	2.89	4.28	5.06	5.49	6.60	7.20	7.46
DISTANZE PARZIALI [m]		2.89	1.39	0.78		1.11	0.60	

Fosso def Tre Canali  
 SEZIONE N° 00174\_\_08

LEGENDA:

TR30 H =6.54 m. s.l.m. ———

TR200 H =6.62 m. s.l.m. ———

TR500 H =6.67 m. s.l.m. - - - - -

SCALA DISTANZE 1:100  
 SCALA QUOTE 1:100

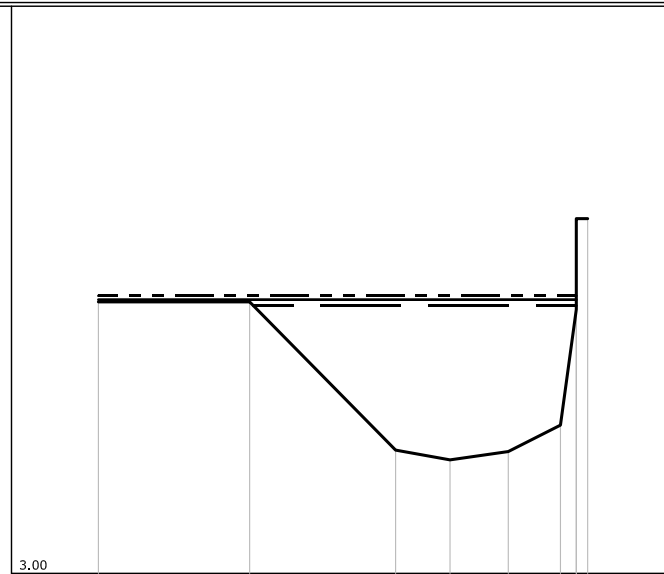

PUNTI	1	2	3	4	5	6	7	9
QUOTE [m s.l.m.]	6.59	6.59	4.63	4.50	4.61	4.96	6.49	7.69
DISTANZE PROGRESSIVE [m]	0.00	2.00	3.93	4.65	5.42	6.11	6.32	6.47
DISTANZE PARZIALI [m]		2.00	1.93	0.72	0.77	0.69		

Fosso del Tre Canali  
 SEZIONE N° 00172\_\_08

LEGENDA:

TR30 H = 6.42 m. s.l.m. ———

TR200 H = 6.50 m. s.l.m. ———

TR500 H = 6.58 m. s.l.m. - - - - -

SCALA DISTANZE 1:100  
 SCALA QUOTE 1:100

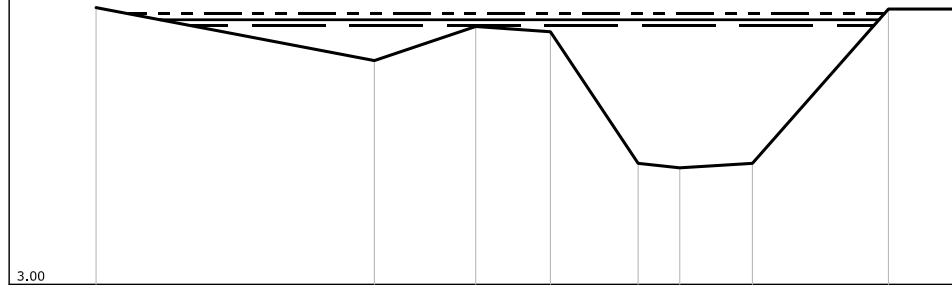

PUNTI	1	2	3	4	5	6	7	8	9
QUOTE [m s.l.m.]	6.66	5.96	6.41	6.34	4.60	4.54	4.60	6.64	6.64
DISTANZE PROGRESSIVE [m]	0.00	3.68	5.02	6.01	7.17	7.72	8.68	10.48	11.48
DISTANZE PARZIALI [m]		3.68	1.34	0.99	1.16	0.55	0.96	1.80	1.00

Fosso del Tre Canall  
 SEZIONE N° 00168\_\_08

LEGENDA:

TR30 H =6.05 m. s.l.m. ————

TR200 H =6.21 m. s.l.m. ————

TR500 H =6.43 m. s.l.m. - - - - -

SCALA DISTANZE 1:100  
 SCALA QUOTE 1:100

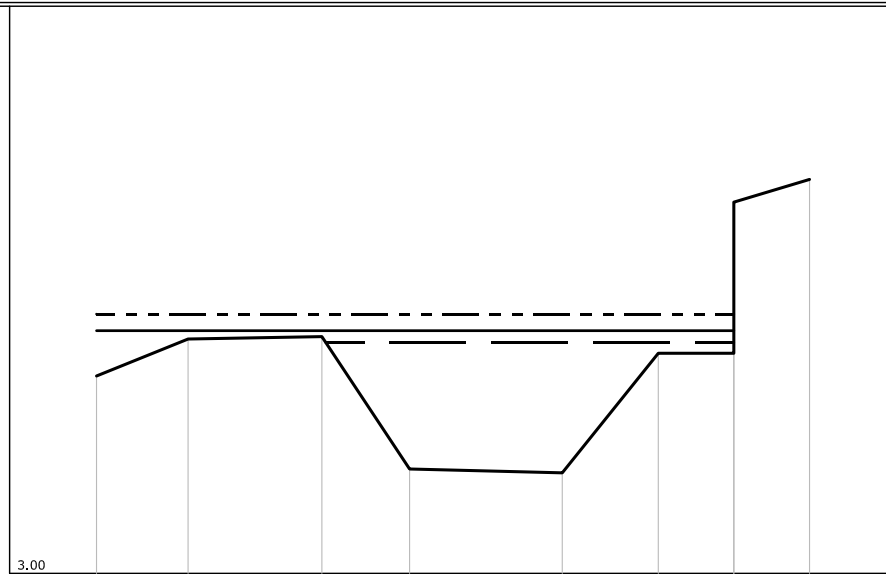

PUNTI	1	2	3	4	5	6	7	9
QUOTE [m s.l.m.]	5.61	6.10	6.13	4.38	4.33	5.91	5.91	8.21
DISTANZE PROGRESSIVE [m]	0.00	1.21	2.98	4.14	6.16	7.43	8.43	9.43
DISTANZE PARZIALI [m]		1.21	1.77	1.16	2.02	1.27	1.00	1.00

Fosso del Tre Canali  
 SEZIONE N° 00165\_\_08

LEGENDA:

TR30 H = 5.96 m. s.l.m. ———

TR200 H = 6.16 m. s.l.m. ———

TR500 H = 6.44 m. s.l.m. - - - - -

SCALA DISTANZE 1:100  
 SCALA QUOTE 1:100

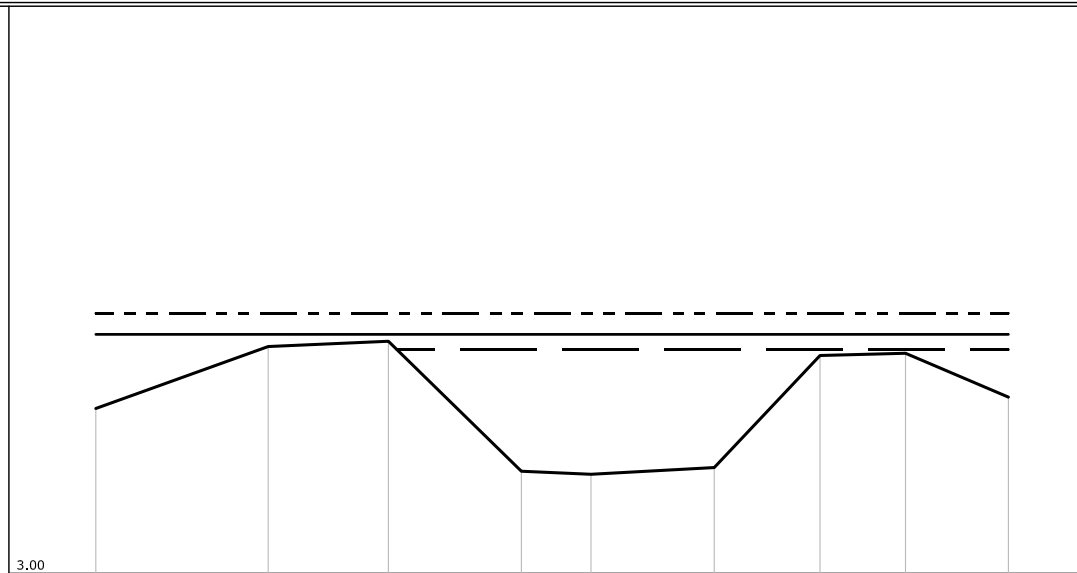

PUNTI	1	2	3	4	5	6	7	8	9
QUOTE [m s.l.m.]	5.18	6.00	6.07	4.35	4.31	4.40	5.88	5.91	5.33
DISTANZE PROGRESSIVE [m]	0.00	2.28	3.87	5.63	6.55	8.18	9.58	10.71	12.07
DISTANZE PARZIALI [m]		2.28	1.59	1.76	0.92	1.63	1.40	1.13	1.36



Fosso del Tre Canali  
 SEZIONE N° 00161\_\_08

LEGENDA:

TR30 H = 5.82 m. s.l.m. ————

TR200 H = 6.14 m. s.l.m. ————

TR500 H = 6.44 m. s.l.m. - - - - -

SCALA DISTANZE 1:100  
 SCALA QUOTE 1:100

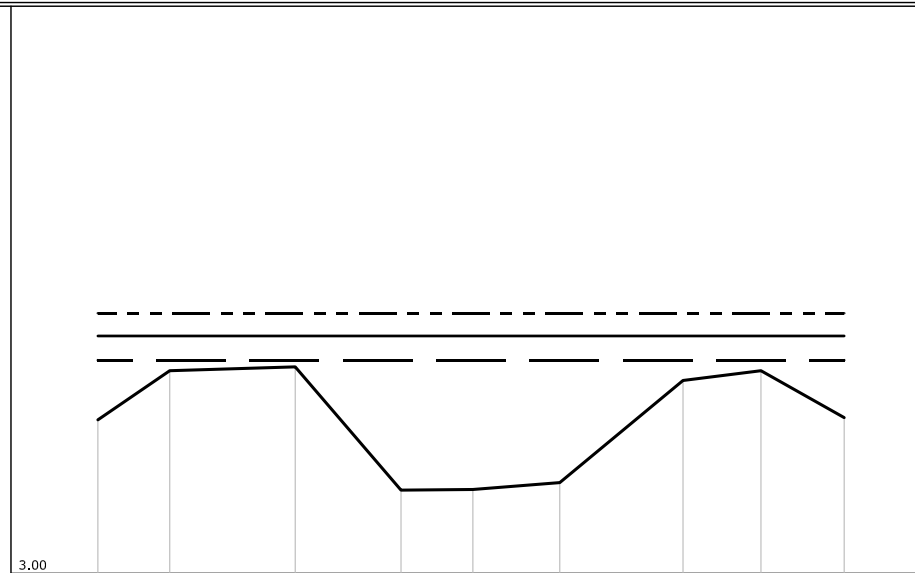

PUNTI	1	2	3	4	5	6	7	8	9
QUOTE [m s.l.m.]	5.03	5.68	5.73	4.10	4.11	4.20	5.55	5.68	5.06
DISTANZE PROGRESSIVE [m]	0.00	0.95	2.61	4.01	4.96	6.11	7.74	8.77	9.87
DISTANZE PARZIALI [m]		0.95	1.66	1.40	0.95	1.15	1.63	1.03	1.10

Fosso del Tre Canali  
 SEZIONE N° 00158\_\_08

LEGENDA:

TR30 H =5.73 m. s.l.m. ————

TR200 H =6.14 m. s.l.m. ————

TR500 H =6.44 m. s.l.m. - - - - -

SCALA DISTANZE 1:100  
 SCALA QUOTE 1:100

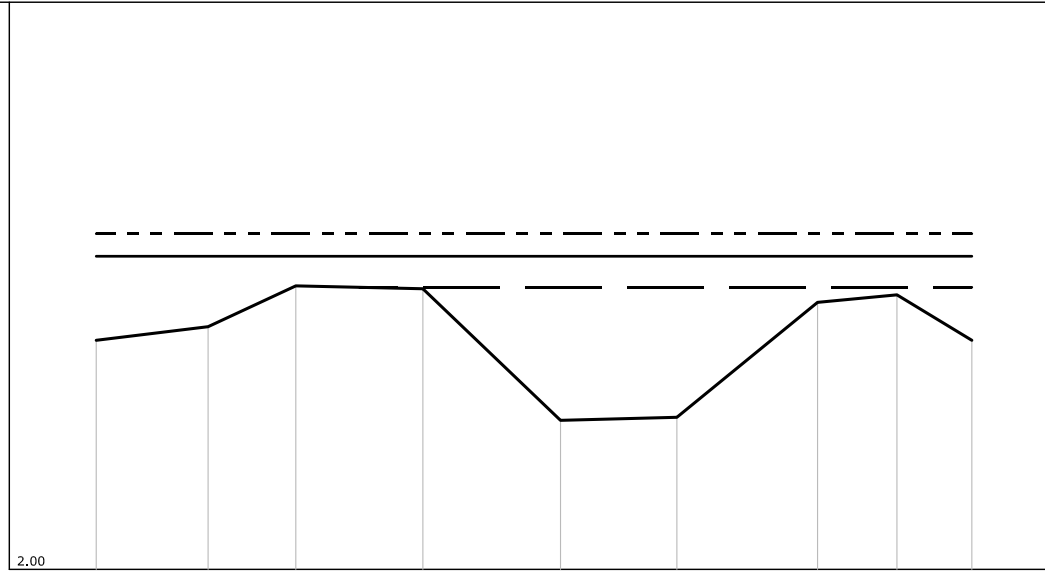



PUNTI	1	2	3	4	5	6	7	8	9
QUOTE [m s.l.m.]	5.03	5.21	5.75	5.71	3.97	4.01	5.53	5.63	5.03
DISTANZE PROGRESSIVE [m]	0.00	1.48	2.64	4.32	6.14	7.68	9.54	10.59	11.58
DISTANZE PARZIALI [m]		1.48	1.16	1.68	1.82	1.54	1.86	1.05	0.99

Fosso del Tre Canali  
 SEZIONE N° 00154\_\_08

LEGENDA:

TR30 H = 5,68 m. s.l.m. 

TR200 H = 6,13 m. s.l.m. 

TR500 H = 6,43 m. s.l.m. 

SCALA DISTANZE 1:100  
 SCALA QUOTE 1:100

2.00

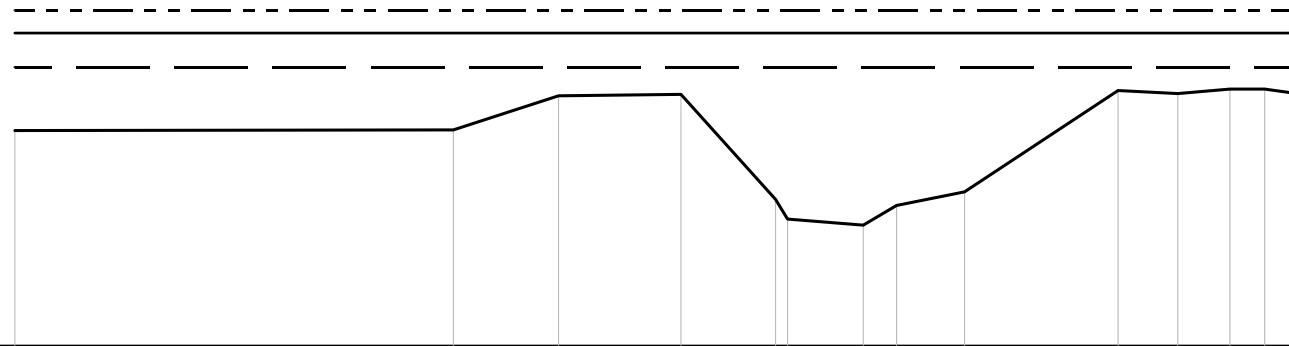



PUNTI	1	2	3	4	5	6	7	8	9	10	11	12	13	14
QUOTE [m s.l.m.]	4.84	4.85	5.30	5.32	3.93	3.67	3.59	3.85	4.03	5.37	5.33	5.39	5.39	5.34
DISTANZE PROGRESSIVE [m]	0.00	5.80	7.19	8.81	10.06	10.22	11.22	11.66	12.56	14.59	15.38	16.07	16.53	16.88
DISTANZE PARZIALI [m]		5.80	1.39	1.62	1.25	1.00	0.90	2.03	0.79	0.69				

Fosso del Tre Canali  
 SEZIONE N° 00150\_\_08

LEGENDA:

TR30 H = 5.71 m. s.l.m. 

TR200 H = 6.14 m. s.l.m. 

TR500 H = 6.43 m. s.l.m. 

SCALA DISTANZE 1:100  
 SCALA QUOTE 1:100

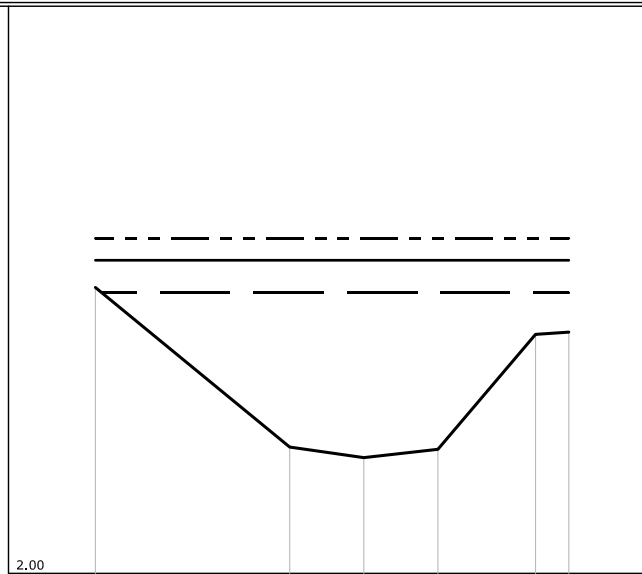

PUNTI	1	2	3	4	5	6
QUOTE [m s.l.m.]	5.78	3.67	3.53	3.64	5.16	5.19
DISTANZE PROGRESSIVE [m]	0.00	2.57	3.55	4.53	5.82	6.26
DISTANZE PARZIALI [m]		2.57	0.98	0.98	1.29	

Fosso del Tre Canali  
 SEZIONE N° 00149\_\_08

LEGENDA:

TR30 H = 5.72 m. s.l.m. ————

TR200 H = 6.14 m. s.l.m. ————

TR500 H = 6.44 m. s.l.m. - - - - -

SCALA DISTANZE 1:100  
 SCALA QUOTE 1:100

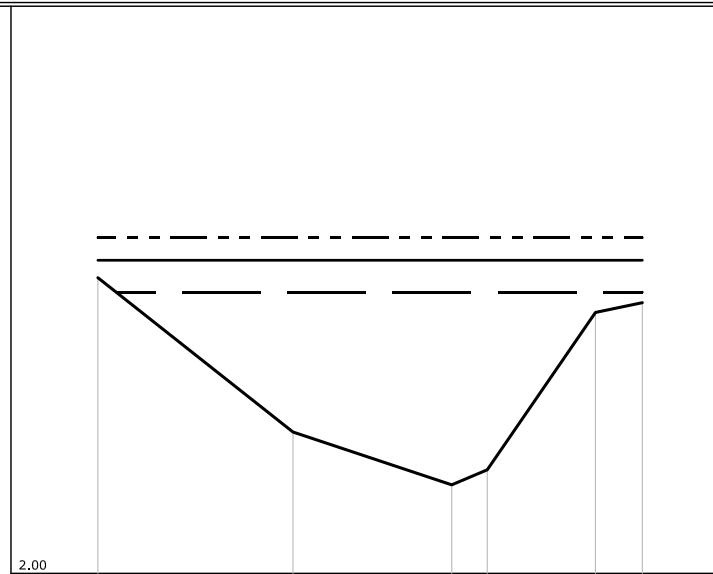

PUNTI	1	2	3	4	5	6
QUOTE [m s.l.m.]	5.91	3.87	3.17	3.37	5.45	5.58
DISTANZE PROGRESSIVE [m]	0.00	2.58	4.68	5.15	6.58	7.20
DISTANZE PARZIALI [m]		2.58	2.10		1.43	0.62

Fosso del Tre Canali  
 SEZIONE N° 00146\_\_08

LEGENDA:

TR30 H = 5.70 m. s.l.m. ———

TR200 H = 6.14 m. s.l.m. ———

TR500 H = 6.43 m. s.l.m. - - - - -

SCALA DISTANZE 1:100  
 SCALA QUOTE 1:100

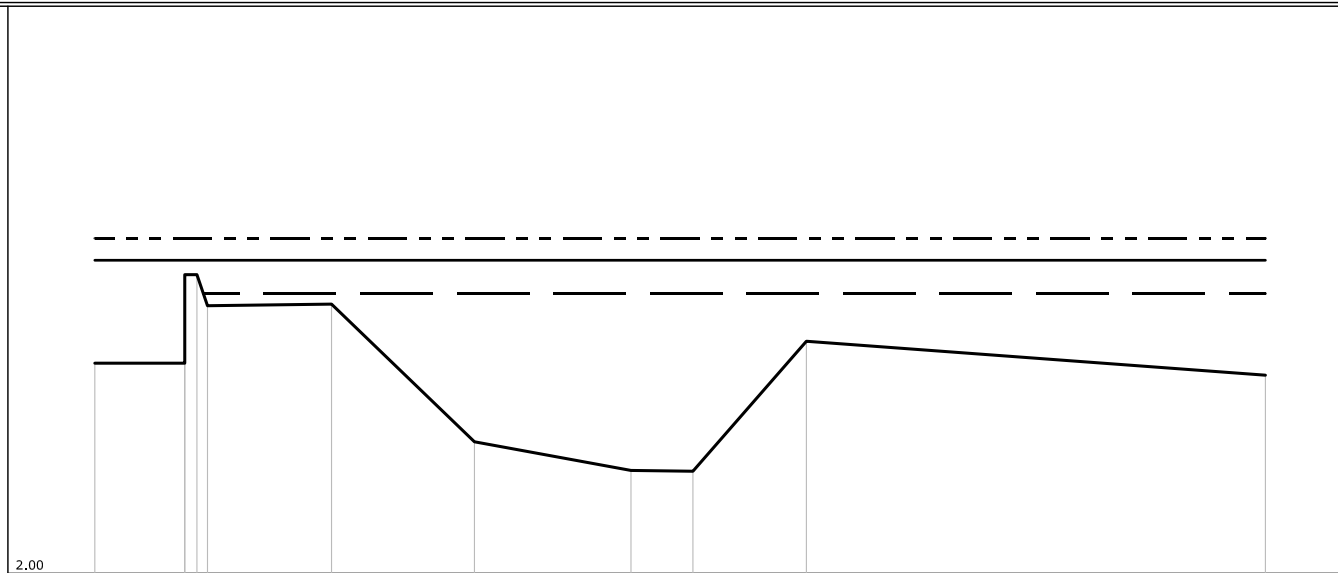

PUNTI	1	2	4	5	6	7	8	9	10	11	
QUOTE [m s.l.m.]	4.78	4.78	5.95	5.94	5.56	3.74	3.36	3.35	5.07	4.62	
DISTANZE PROGRESSIVE [m]	0.00	1.19	1.33	1.49	3.13	5.02	7.09	7.91	9.41	15.48	
DISTANZE PARZIALI [m]		1.19			1.64	1.89	2.07	0.82	1.50	6.07	

Fosso del Tre Canali  
 SEZIONE N° 00141\_\_08

LEGENDA:

TR30 H = 5.69 m. s.l.m. 

TR200 H = 6.12 m. s.l.m. 

TR500 H = 6.42 m. s.l.m. 

SCALA DISTANZE 1:100  
 SCALA QUOTE 1:100

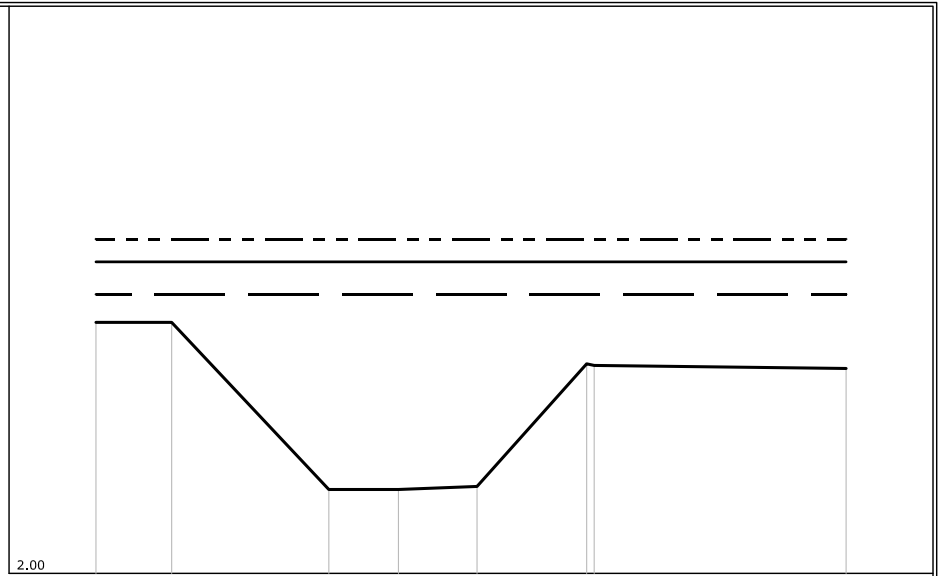

PUNTI	1	2	3	4	5	6	8
QUOTE [m s.l.m.]	5.32	5.32	3.11	3.11	3.15	4.77	4.71
DISTANZE PROGRESSIVE [m]	0.00	1.00	3.08	4.00	5.04	6.49	9.92
DISTANZE PARZIALI [m]		1.00	2.08	0.92	1.04	1.45	3.33

Fosso del Tre Canali  
 SEZIONE N° 00139PA08

LEGENDA:

- TR30 H = 5.75 m. s.l.m.
- TR200 H = 6.08 m. s.l.m.
- TR500 H = 6.39 m. s.l.m.

SCALA DISTANZE 1:100  
 SCALA QUOTE 1:100

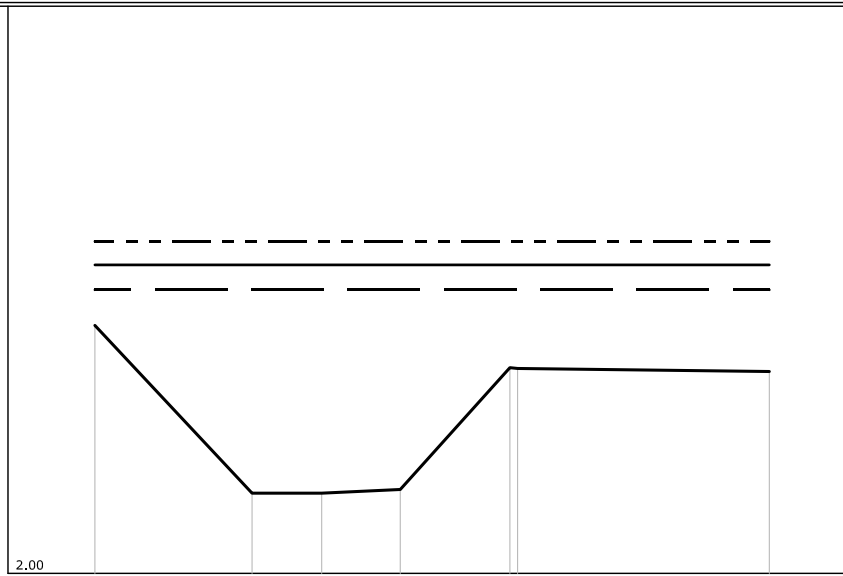

PUNTI	1	2	3	4	5	7
QUOTE [m s.l.m.]	5.28	3.06	3.06	3.11	4.72	4.67
DISTANZE PROGRESSIVE [m]	0.00	2.08	3.00	4.04	5.49	8.92
DISTANZE PARZIALI [m]		2.08	0.92	1.04	1.45	3.33



Fosso def Tre Canall  
 SEZIONE N° 00139PB08

LEGENDA:

TR30 H =5.73 m. s.l.m. ————

TR200 H =6.06 m. s.l.m. ————

TR500 H =6.35 m. s.l.m. - - - - -

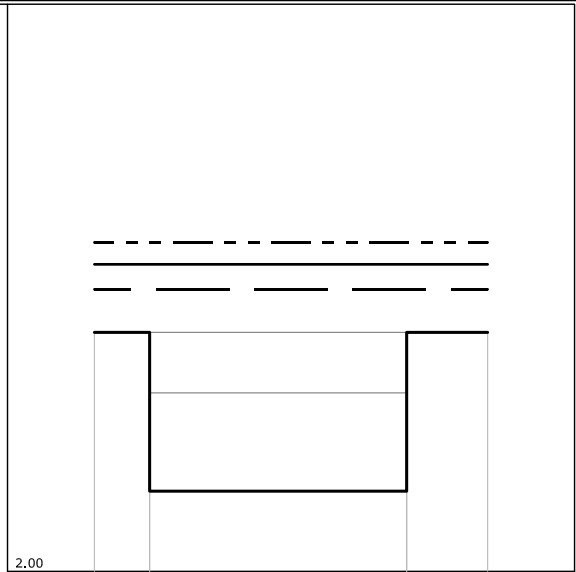

SCALA DISTANZE 1:100  
 SCALA QUOTE 1:100

PUNTI	1	2	4	6
QUOTE [m s.l.m.]	5.16	5.16	3.06	5.16
DISTANZE PROGRESSIVE [m]	0.00	0.73	4.13	5.20
DISTANZE PARZIALI [m]	0.73	3.40	1.07	

Fosso def Tre Canall  
 SEZIONE N° 00139PC08

LEGENDA:

TR30 H =5.70 m. s.l.m. \_\_\_\_\_

TR200 H =5.98 m. s.l.m. \_\_\_\_\_

TR500 H =6.26 m. s.l.m. - - - - -

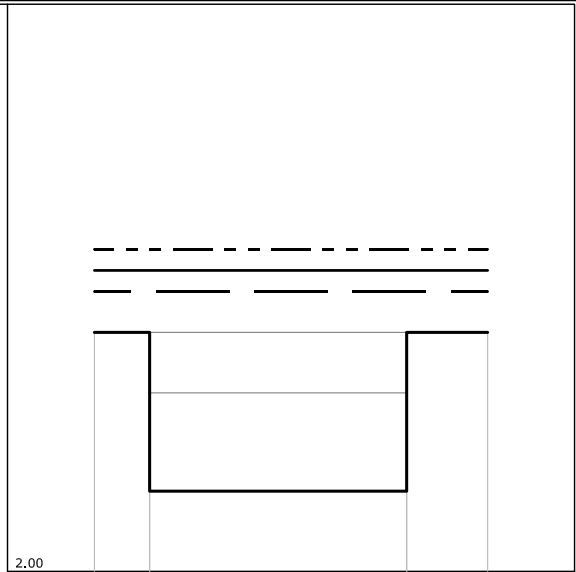

SCALA DISTANZE 1:100  
 SCALA QUOTE 1:100

PUNTI	1	2	4	6
QUOTE [m s.l.m.]	5.16	5.16	3.06	5.16
DISTANZE PROGRESSIVE [m]	0.00	0.73	4.13	5.20
DISTANZE PARZIALI [m]	0.73	3.40	1.07	

Fosso del Tre Canali  
 SEZIONE N° 00139PD08

LEGENDA:

TR30 H = 5.71 m. s.l.m. ———

TR200 H = 6.08 m. s.l.m. ———

TR500 H = 6.39 m. s.l.m. - - - - -

SCALA DISTANZE 1:100  
 SCALA QUOTE 1:100

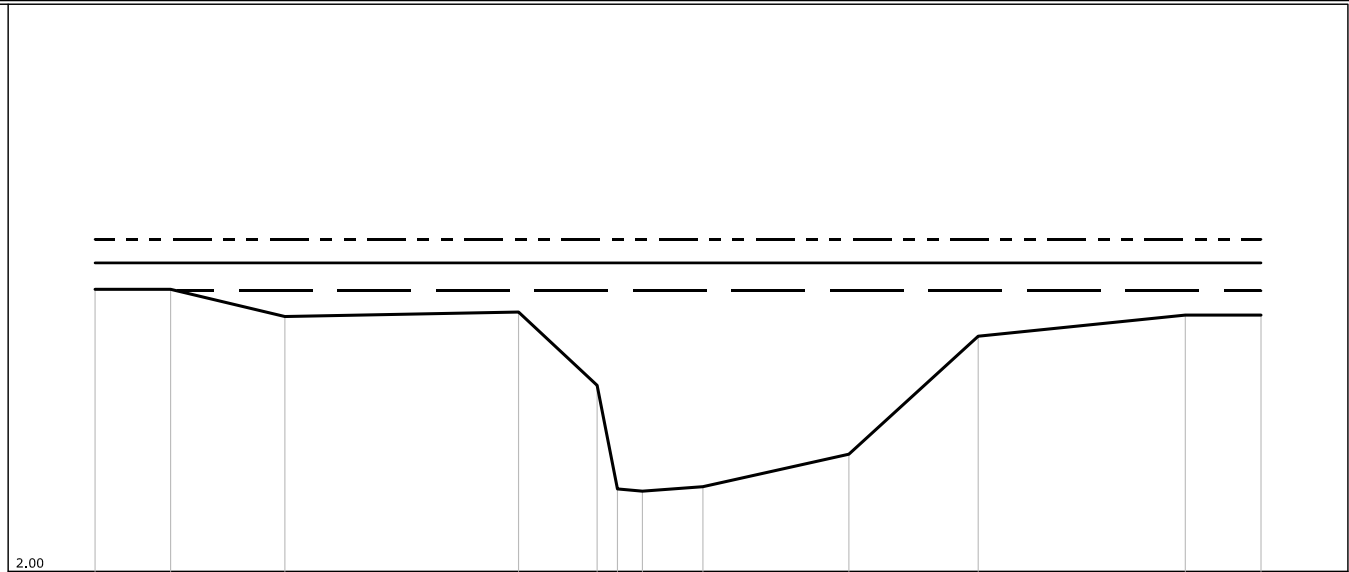

PUNTI	1	2	3	4	5	6	7	8	9	10	11	12
QUOTE [m s.l.m.]	5.73	5.73	5.37	5.43	4.46	3.09	3.06	3.12	3.55	5.11	5.39	5.39
DISTANZE PROGRESSIVE [m]	0.00	1.00	2.51	5.60	6.64	6.91	7.24	8.04	9.97	11.68	14.42	15.42
DISTANZE PARZIALI [m]		1.00	1.51	3.09	1.04		0.80	1.93	1.71	2.74	1.00	

Fosso del Tre Canali  
 SEZIONE N° 00137\_\_08

LEGENDA:

TR30 H = 5.83 m. s.l.m. 

TR200 H = 6.06 m. s.l.m. 

TR500 H = 6.38 m. s.l.m. 

SCALA DISTANZE 1:100  
 SCALA QUOTE 1:100

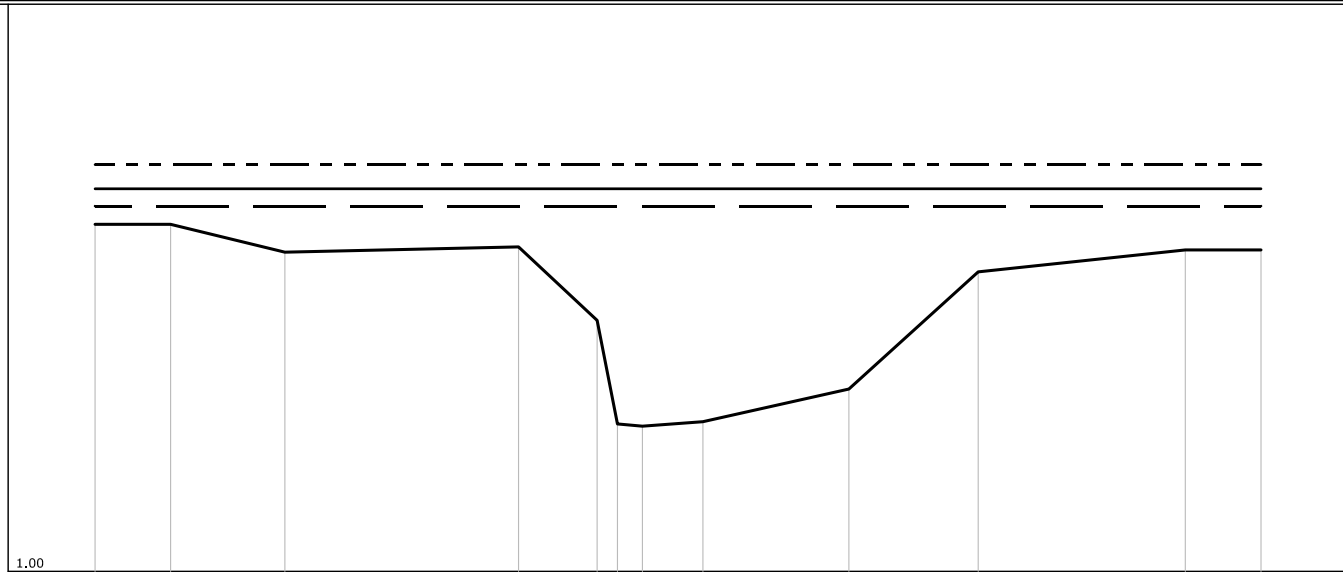

PUNTI	1	2	3	4	5	6	7	8	9	10	11	12
QUOTE [m s.l.m.]	5.59	5.59	5.22	5.29	4.32	2.95	2.92	2.98	3.41	4.96	5.25	5.25
DISTANZE PROGRESSIVE [m]	0.00	1.00	2.51	5.60	6.64	6.91	7.24	8.04	9.97	11.68	14.42	15.42
DISTANZE PARZIALI [m]	1.00	1.51	3.09	1.04			0.80	1.93	1.71	2.74	1.00	

Fosso del Tre Canali  
 SEZIONE N° 00136PA08

LEGENDA:

TR30 H = 5.91 m. s.l.m. 

TR200 H = 6.25 m. s.l.m. 

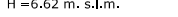
TR500 H = 6.62 m. s.l.m. 

SCALA DISTANZE 1:100  
 SCALA QUOTE 1:100

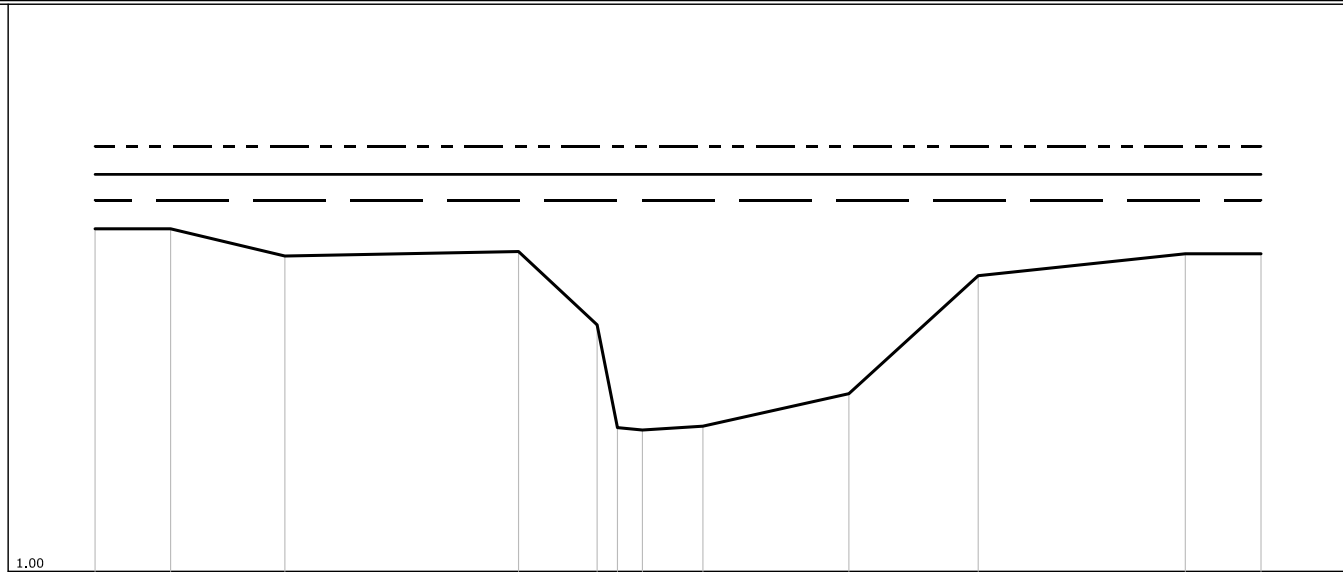

PUNTI	1	2	3	4	5	6	7	8	9	10	11	12
QUOTE [m s.l.m.]	5.53	5.53	5.17	5.23	4.26	2.90	2.87	2.92	3.35	4.91	5.20	5.20
DISTANZE PROGRESSIVE [m]	0.00	1.00	2.51	5.60	6.64	6.91	7.24	8.04	9.97	11.68	14.42	15.42
DISTANZE PARZIALI [m]		1.00	1.51	3.09	1.04		0.80	1.93	1.71	2.74	1.00	





Fosso del Tre Canali  
 SEZIONE N° 00136PD08

LEGENDA:

TR30 H = 6.31 m. s.l.m. ————

TR200 H = 6.70 m. s.l.m. ————

TR500 H = 7.01 m. s.l.m. - - - - -

SCALA DISTANZE 1:100  
 SCALA QUOTE 1:100

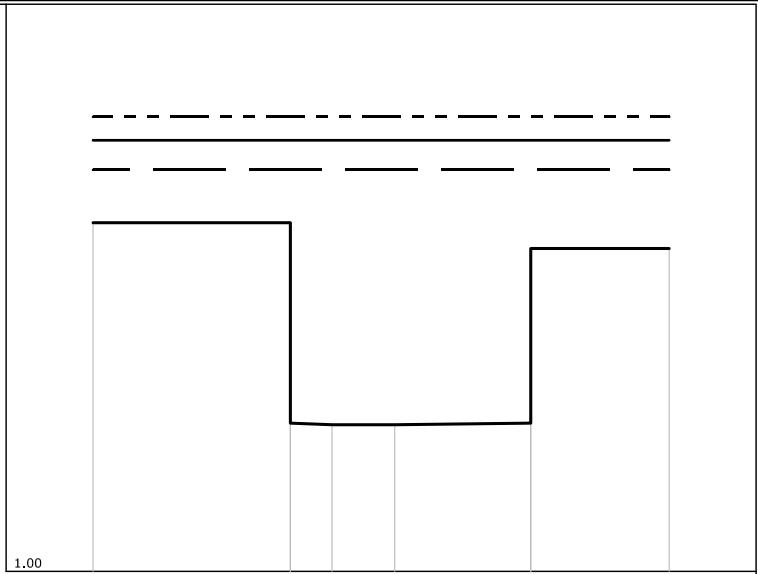

PUNTI	1	2	4	5	6	8
QUOTE [m s.l.m.]	5.61	5.61	2.94	2.94	2.96	5.27
DISTANZE PROGRESSIVE [m]	0.00	2.61	3.16	3.99	5.79	7.62
DISTANZE PARZIALI [m]		2.61	0.55	0.83	1.80	1.83









Fosso del Tre Canali  
 SEZIONE N° 00135\_\_08

LEGENDA:

TR30 H = 5.82 m. s.l.m. 

TR200 H = 5.98 m. s.l.m. 

TR500 H = 6.01 m. s.l.m. 

SCALA DISTANZE 1:100  
 SCALA QUOTE 1:100

2.00

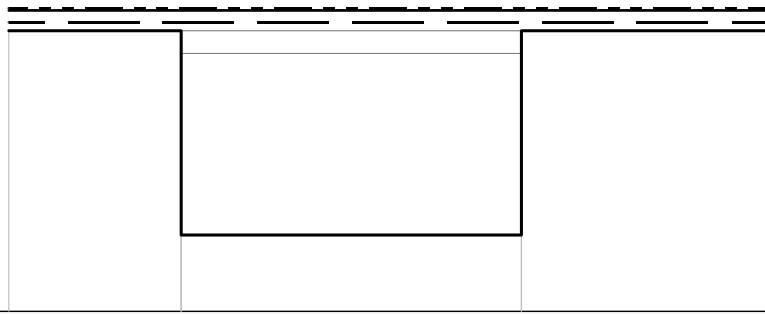

PUNTI	1	2	4	6
QUOTE [m s.l.m.]	5.71	5.71	3.01	5.71
DISTANZE PROGRESSIVE [m]	0.00	2.28	6.78	10.03
DISTANZE PARZIALI [m]		2.28	4.50	3.25

Fosso del Tre Canali  
 SEZIONE N° 00134\_\_08

LEGENDA:

TR30 H =5.82 m. s.l.m. ———

TR200 H =5.98 m. s.l.m. ———

TR500 H =6.01 m. s.l.m. - - - - -

SCALA DISTANZE 1:100  
 SCALA QUOTE 1:100

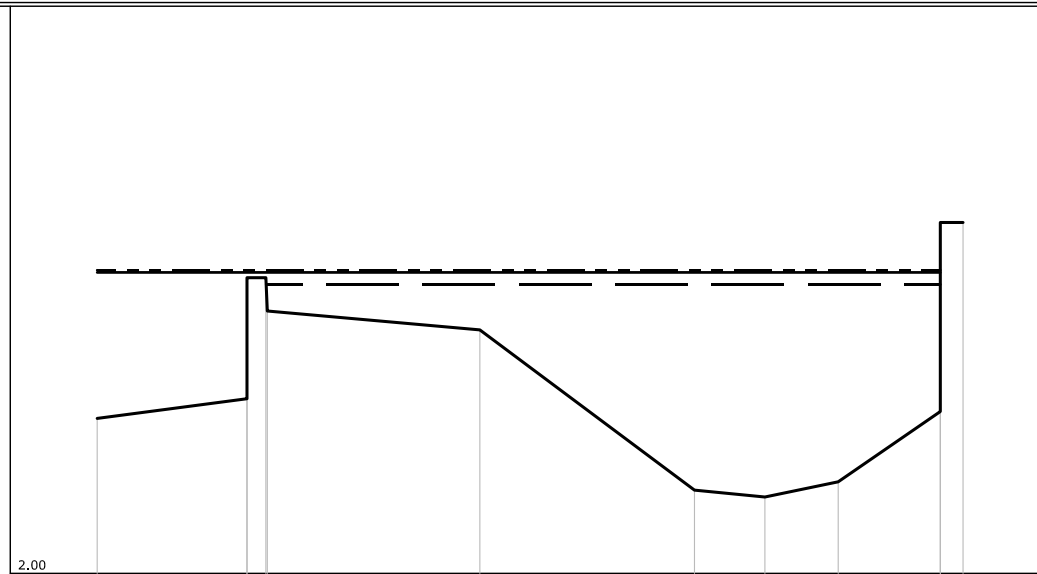

PUNTI	1	2	4	6	7	8	9	10	12
QUOTE [m s.l.m.]	4.05	4.31	5.91	5.22	3.10	3.01	3.21	4.14	6.64
DISTANZE PROGRESSIVE [m]	0.00	1.98	2.23	5.06	7.90	8.83	9.80	11.15	11.45
DISTANZE PARZIALI [m]		1.98		2.81	2.84	0.93	0.97	1.35	

Fosso del Tre Canali  
 SEZIONE N° 00120\_08

LEGENDA:  
 TR30 H =5.37 m. s.l.m. ———  
 TR200 H =5.44 m. s.l.m. ———  
 TR500 H =5.45 m. s.l.m. - - - - -

SCALA DISTANZE 1:100  
 SCALA QUOTE 1:100

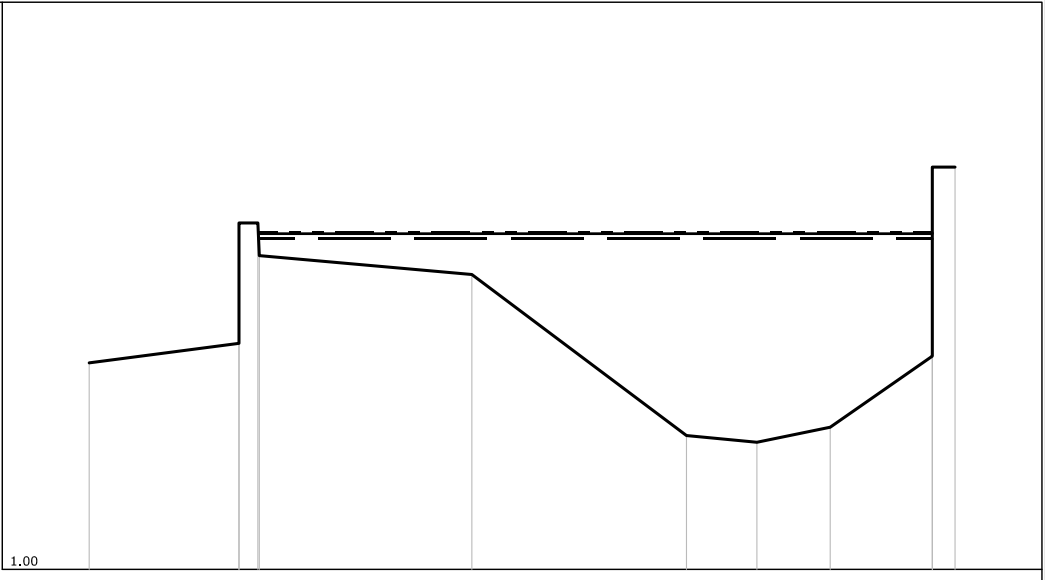

PUNTI	1	2	4	6	7	8	9	10	12
QUOTE [m s.l.m.]	3.73	3.99	5.58	4.90	2.77	2.68	2.88	3.82	6.32
DISTANZE PROGRESSIVE [m]	0.00	1.98	2.23	5.06	7.90	8.83	9.80	11.15	11.45
DISTANZE PARZIALI [m]		1.98		2.81	2.84	0.93	0.97	1.35	

Fosso del Tre Canali  
 SEZIONE N° 00118\_\_08

LEGENDA:

- TR30 H =5.27 m. s.l.m.
- TR200 H =5.32 m. s.l.m.
- TR500 H =5.33 m. s.l.m.

SCALA DISTANZE 1:100  
 SCALA QUOTE 1:100

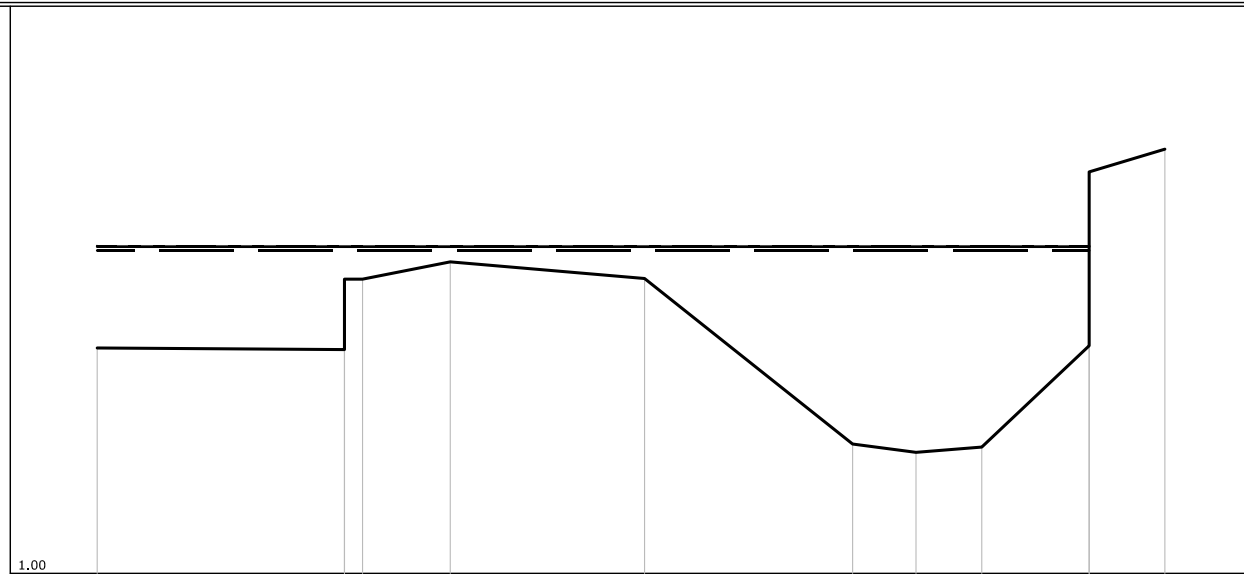

PUNTI	1	2	4	5	6	7	8	9	10	12	
QUOTE [m s.l.m.]	3.98	3.96	4.89	5.12	4.90	2.71	2.60	2.67	4.01	6.61	
DISTANZE PROGRESSIVE [m]	0.00	3.27	3.51	4.67	7.24	9.99	10.83	11.70	13.12	14.12	
DISTANZE PARZIALI [m]		3.27		1.16	2.57		2.75	0.84	0.87	1.42	1.00

Fosso del Tre Canali  
 SEZIONE N° 00113\_\_08

LEGENDA:

TR30 H = 5.03 m. s.l.m. ———

TR200 H = 5.04 m. s.l.m. ———

TR500 H = 5.04 m. s.l.m. - - - - -

SCALA DISTANZE 1:100  
 SCALA QUOTE 1:100

1.00

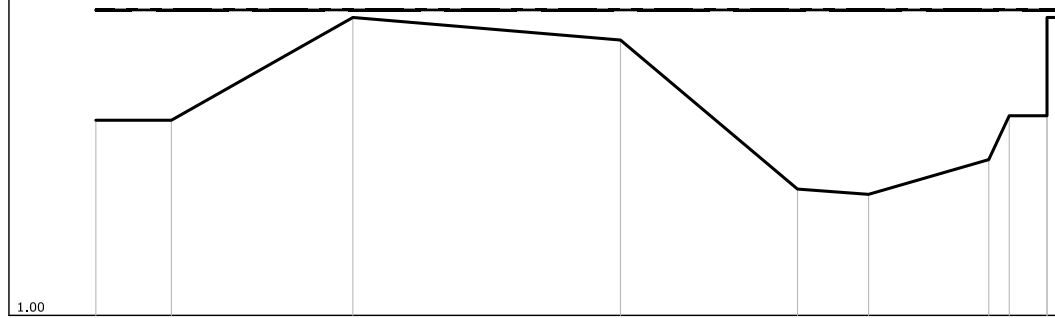

PUNTI	1	2	3	4	5	6	7	8	9	11
QUOTE [m s.l.m.]	3.58	3.58	4.94	4.64	2.67	2.60	3.06	3.64	3.64	4.94
DISTANZE PROGRESSIVE [m]	0.00	1.00	3.40	6.94	9.28	10.22	11.81	12.08	12.58	12.73
DISTANZE PARZIALI [m]		1.00	2.40	3.54	2.34	0.94	1.59		0.50	

Fosso del Tre Canali  
 SEZIONE N° 00109\_\_08

LEGENDA:

TR30 H = 5.00 m. s.l.m. ———

TR200 H = 5.01 m. s.l.m. ———

TR500 H = 5.01 m. s.l.m. - - - - -

SCALA DISTANZE 1:100  
 SCALA QUOTE 1:100

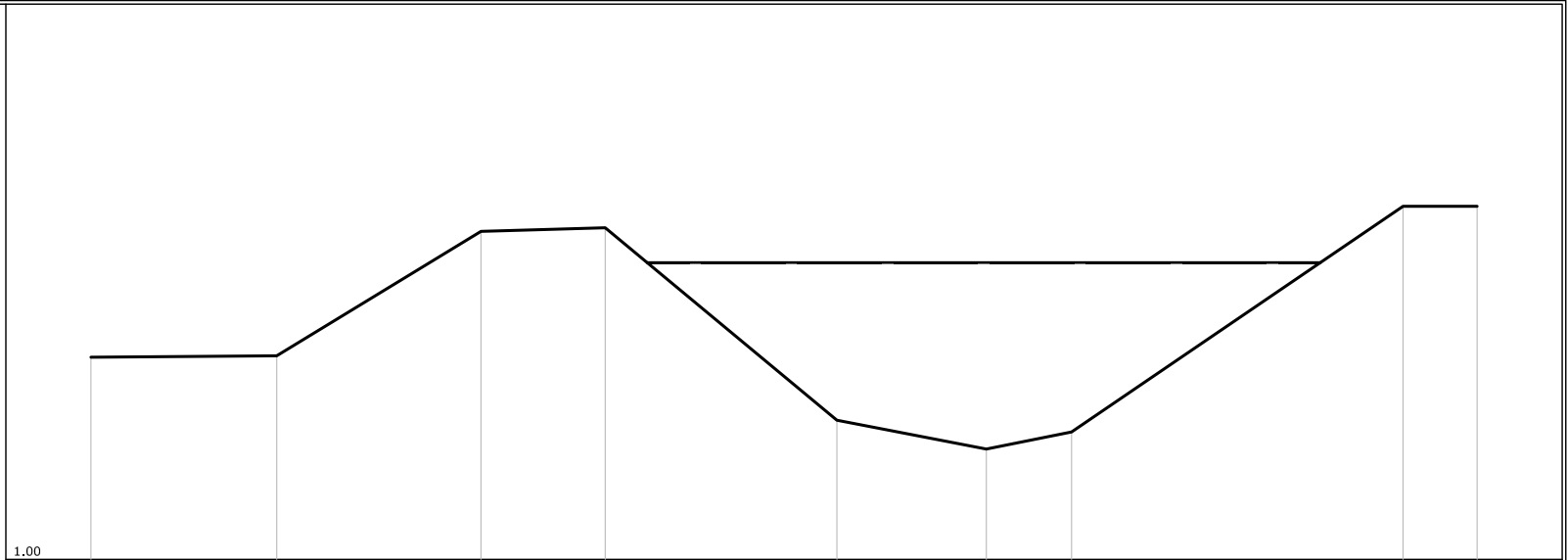

PUNTI	1	2	3	4	5	6	7	8	9
QUOTE [m s.l.m.]	3.73	3.75	5.43	5.48	2.88	2.49	2.72	5.77	5.77
DISTANZE PROGRESSIVE [m]	0.00	2.51	5.27	6.95	10.08	12.10	13.25	17.73	18.73
DISTANZE PARZIALI [m]		2.51	2.76	1.68	3.13	2.02	1.15	4.48	1.00



Fosso del Tre Canali  
 SEZIONE N° 00107\_\_08

LEGENDA:

TR30 H = 4.92 m. s.l.m. ———

TR200 H = 4.94 m. s.l.m. ———

TR500 H = 4.94 m. s.l.m. - - - - -

SCALA DISTANZE 1:100  
 SCALA QUOTE 1:100

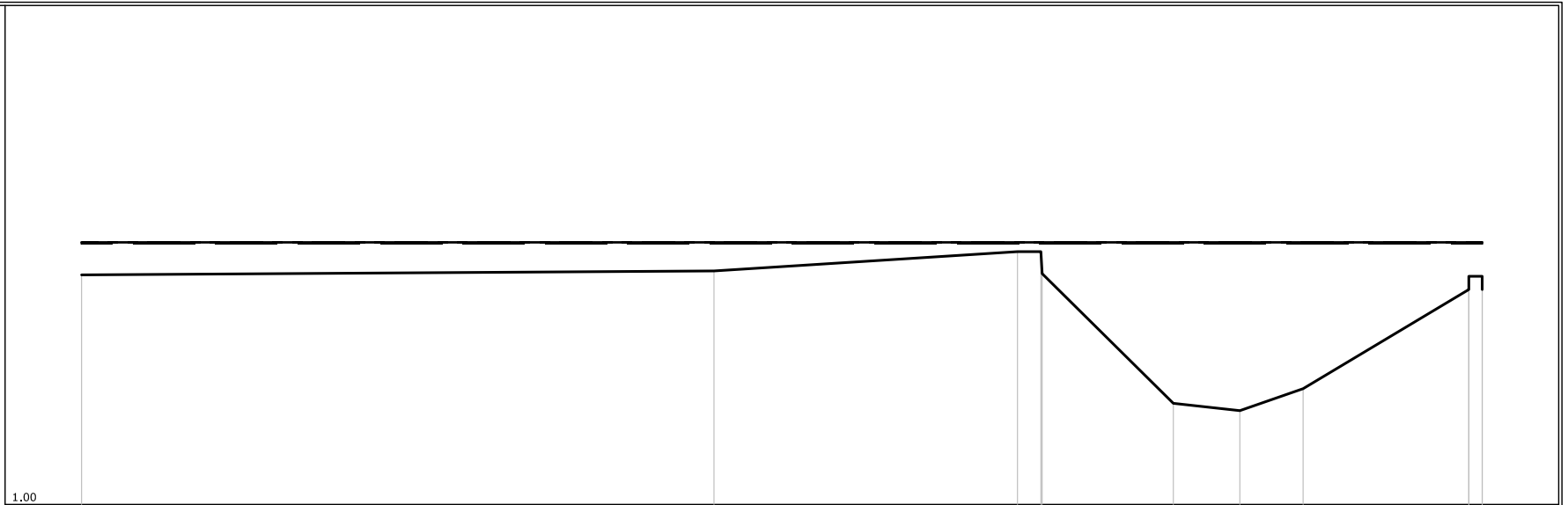

PUNTI	1	2	3	4	6	7	8	9	11
QUOTE [m s.l.m.]	4.45	4.51	4.80	4.80	2.52	2.41	2.74	4.23	4.43
DISTANZE PROGRESSIVE [m]	0.00	9.50	14.06	14.41	16.40	17.40	18.35	20.84	21.04
DISTANZE PARZIALI [m]		9.50		4.56		1.97	1.00	0.95	2.49

Fosso del Tre Canali  
 SEZIONE N° 00103\_\_08

LEGENDA:

- TR30 H =4,86 m. s.l.m.
- TR200 H =4,88 m. s.l.m.
- TR500 H =4,88 m. s.l.m.

SCALA DISTANZE 1:100  
 SCALA QUOTE 1:100

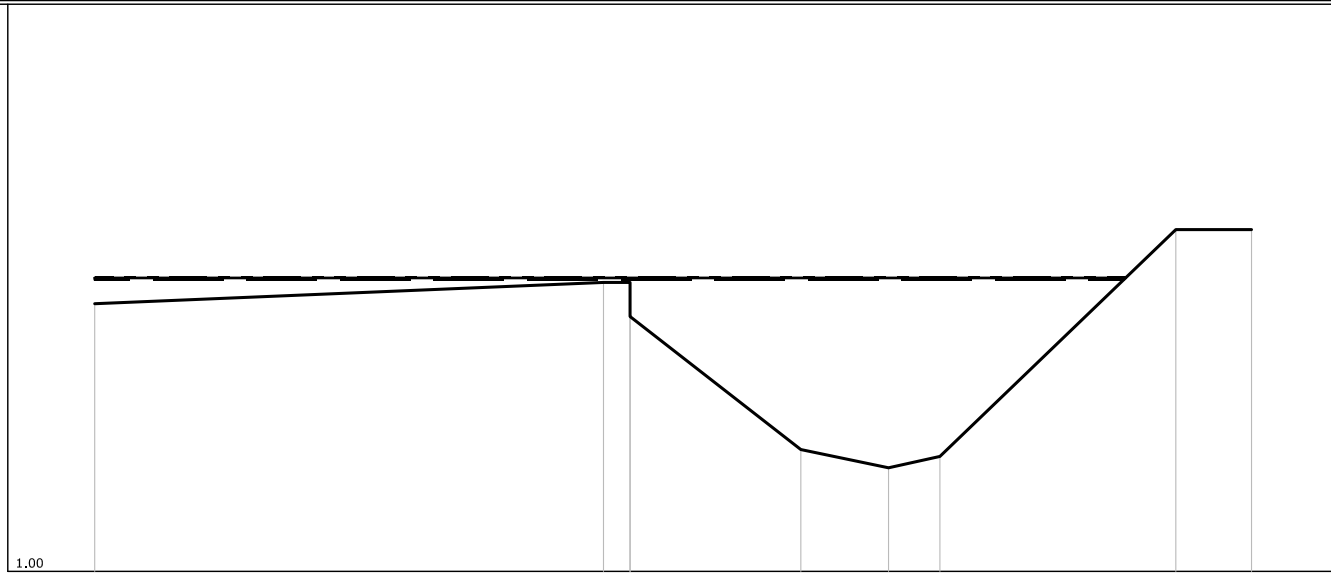

PUNTI	1	2	3	5	6	7	8	9
QUOTE [m s.l.m.]	4.54	4.82	4.82	2.61	2.37	2.52	5.52	5.52
DISTANZE PROGRESSIVE [m]	0.00	6.73	7.08	9.34	10.50	11.18	14.30	15.30
DISTANZE PARZIALI [m]		6.73		2.26	1.16	0.68	3.12	1.00

Fosso del Tre Canali  
 SEZIONE N° 00099\_\_08

LEGENDA:

TR30 H = 4.80 m. s.l.m. \_\_\_\_\_

TR200 H = 4.81 m. s.l.m. \_\_\_\_\_

TR500 H = 4.82 m. s.l.m. \_\_\_\_\_

SCALA DISTANZE 1:100  
 SCALA QUOTE 1:100

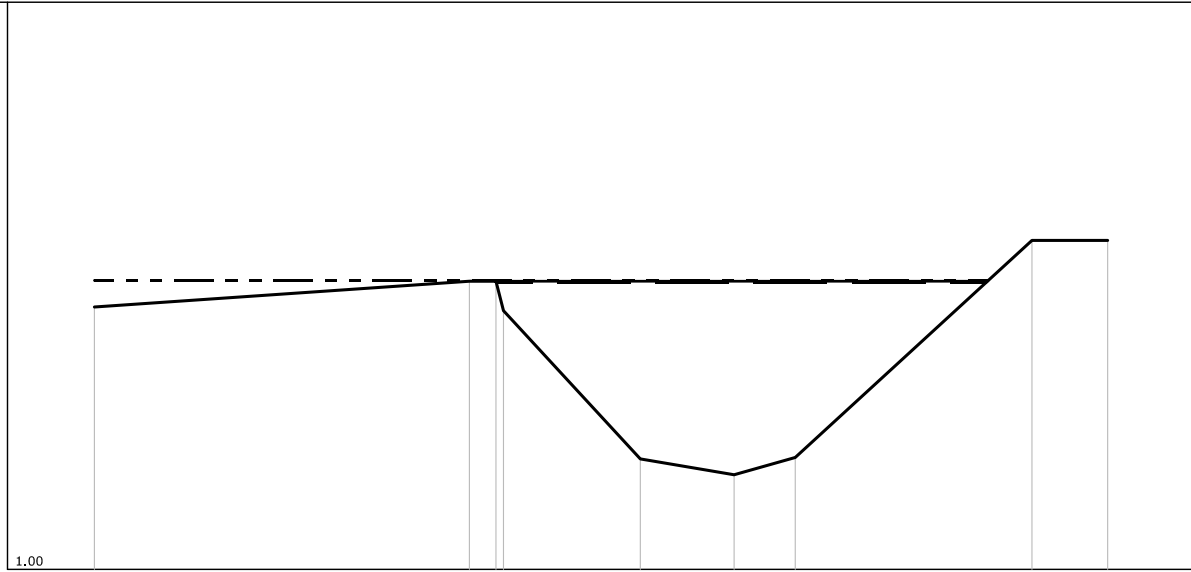

PUNTI	1	2	3	5	6	7	8	9
QUOTE [m s.l.m.]	4.47	4.81	4.81	2.46	2.25	2.48	5.35	5.35
DISTANZE PROGRESSIVE [m]	0.00	4.96	5.31	7.22	8.46	9.27	12.40	13.40
DISTANZE PARZIALI [m]		4.96		1.81	1.24	0.81	3.13	1.00

Fosso del Tre Canali  
 SEZIONE N° 00098\_\_08

LEGENDA:

TR30 H =4.80 m. s.l.m. ———

TR200 H =4.82 m. s.l.m. ———

TR500 H =4.82 m. s.l.m. - - - - -

SCALA DISTANZE 1:100  
 SCALA QUOTE 1:100

1.00

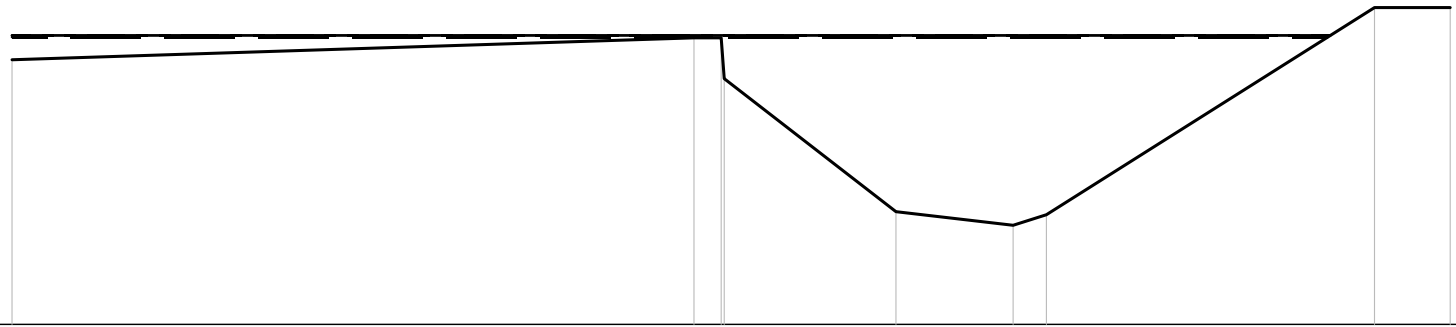

PUNTI	1	2	3	5	6	7	8	9
QUOTE [m s.l.m.]	4.50	4.79	4.79	2.49	2.31	2.45	5.19	5.19
DISTANZE PROGRESSIVE [m]	0.00	9.02	9.38	11.69	13.24	13.68	18.02	19.02
DISTANZE PARZIALI [m]		9.02		2.27	1.55		4.34	1.00

Fosso del Tre Canali  
 SEZIONE N° 00096\_\_06

LEGENDA:

TR30 H = 4.77 m. s.l.m. \_\_\_\_\_

TR200 H = 4.79 m. s.l.m. \_\_\_\_\_

TR500 H = 4.79 m. s.l.m. - - - - -

SCALA DISTANZE 1:100  
 SCALA QUOTE 1:100

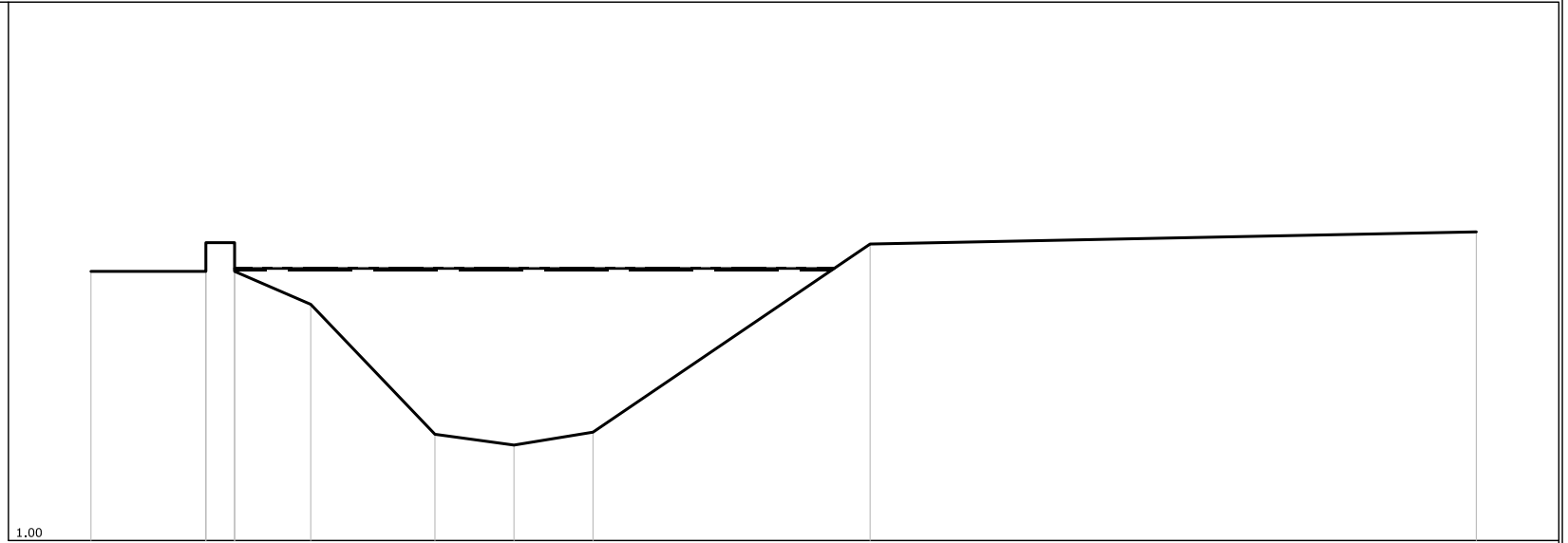

PUNTI	1	2	4	6	7	8	9	10	11
QUOTE [m s.l.m.]	4.75	4.75	5.15	4.29	2.48	2.33	2.51	5.13	5.30
DISTANZE PROGRESSIVE [m]	0.00	1.60	2.00	3.06	4.79	5.89	6.99	10.85	19.29
DISTANZE PARZIALI [m]		1.60		1.06	1.73	1.10	1.10	3.86	8.44

Fosso def Tre Canall  
 SEZIONE N° 00094\_\_08

LEGENDA:

TR30 H =4.71 m. s.l.m. ———

TR200 H =4.72 m. s.l.m. ———

TR500 H =4.73 m. s.l.m. - - - - -

SCALA DISTANZE 1:100  
 SCALA QUOTE 1:100

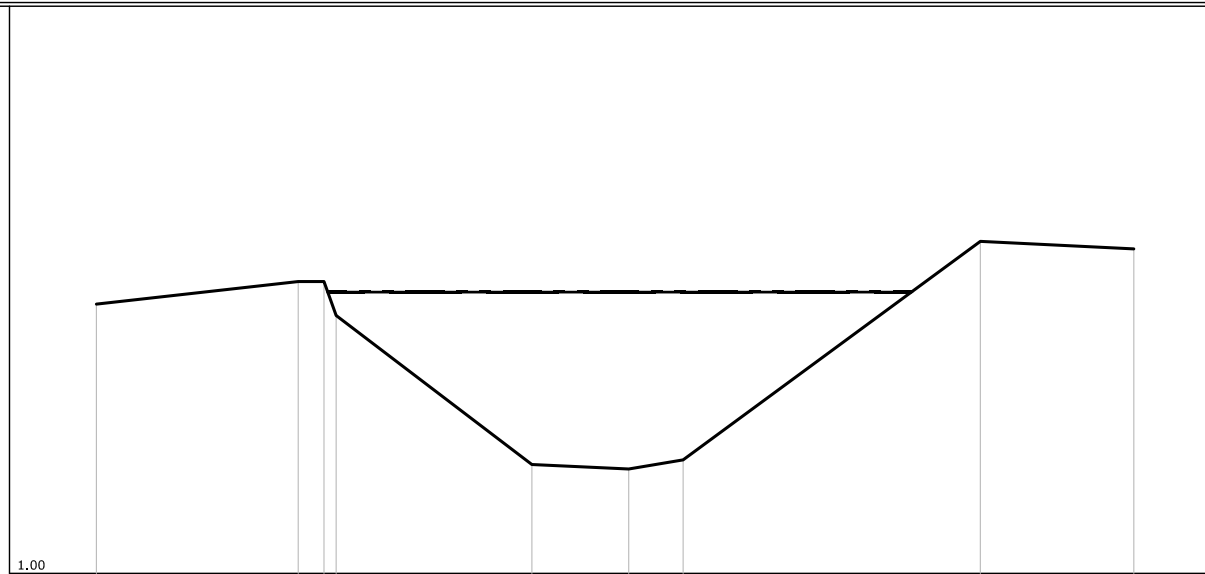

PUNTI	1	2	3	4	5	6	7	8	9
QUOTE [m s.l.m.]	4.56	4.86	4.86	4.41	2.44	2.38	2.50	5.39	5.29
DISTANZE PROGRESSIVE [m]	0.00	2.67	3.01	3.17	5.76	7.04	7.76	11.69	13.72
DISTANZE PARZIALI [m]		2.67			2.59	1.28	0.72	3.93	2.03

Fosso del Tre Canali  
 SEZIONE N° 00093\_\_06

LEGENDA:

TR30 H =4.66 m. s.l.m. ———

TR200 H =4.68 m. s.l.m. ———

TR500 H =4.68 m. s.l.m. - - - - -

SCALA DISTANZE 1:100  
 SCALA QUOTE 1:100

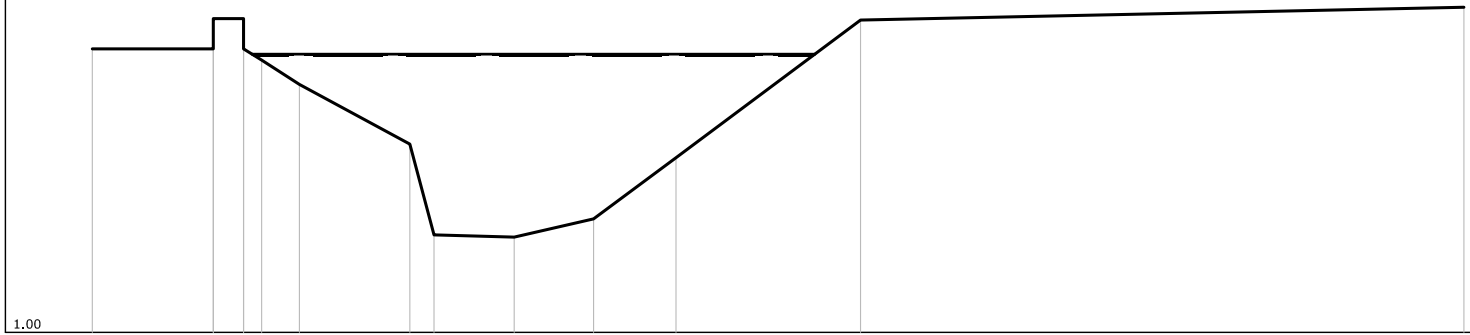

PUNTI	1	2	4	6	7	8	9	10	11	12	13	14
QUOTE [m s.l.m.]	4.75	4.75	5.15	4.60	4.28	3.49	2.29	2.26	2.50	3.31	5.13	5.30
DISTANZE PROGRESSIVE [m]	0.00	1.60	2.00	2.24	2.74	4.20	4.52	5.58	6.63	7.72	10.16	18.14
DISTANZE PARZIALI [m]		1.60		0.50	1.46		1.06	1.05	1.09	2.44	7.98	

Fosso del Tre Canali  
 SEZIONE N° 00092\_\_08

LEGENDA:

TR30 H=4.64 m. s.l.m. ————

TR200 H=4.66 m. s.l.m. ————

TR500 H=4.67 m. s.l.m. - - - - -

SCALA DISTANZE 1:100  
 SCALA QUOTE 1:100

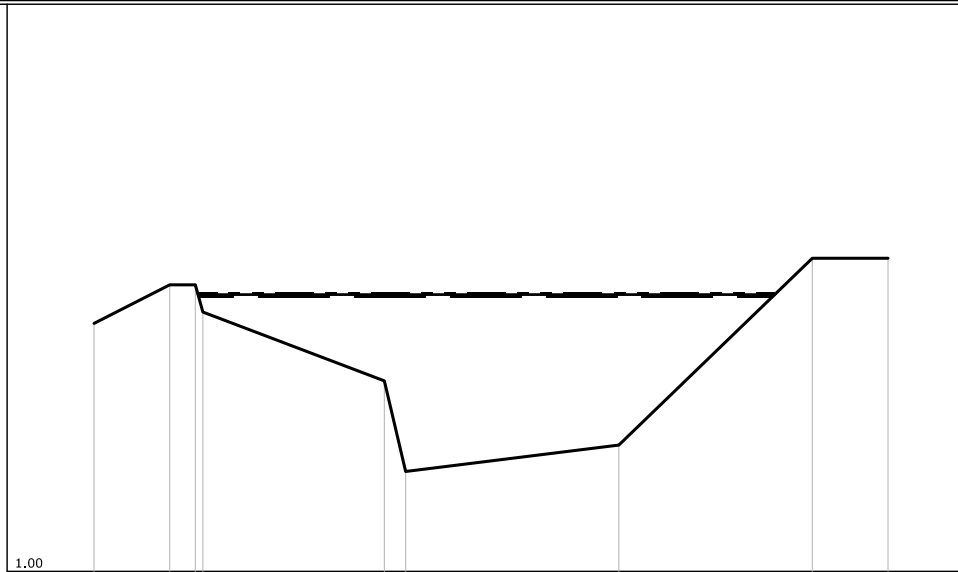

PUNTI	1	2	3	5	6	7	8	9
QUOTE [m s.l.m.]	4.28	4.79	4.79	3.52	2.32	2.67	5.14	5.14
DISTANZE PROGRESSIVE [m]	0.00	1.00	1.34	3.84	4.12	6.94	9.50	10.50
DISTANZE PARZIALI [m]	1.00			2.40		2.82	2.56	1.00



Fosso del Tre Canali  
 SEZIONE N° 00091PA06

LEGENDA:

- TR30 H = 4.63 m. s.l.m.
- TR200 H = 4.65 m. s.l.m.
- TR500 H = 4.65 m. s.l.m.

SCALA DISTANZE 1:100  
 SCALA QUOTE 1:100

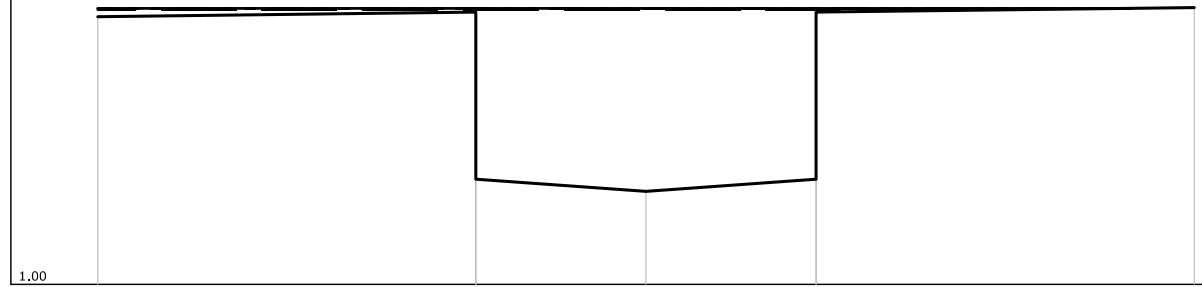

PUNTI	1	2	4	5	7
QUOTE [m s.l.m.]	4.54	4.60	2.23	2.39	4.66
DISTANZE PROGRESSIVE [m]	0.00	5.00	7.25	9.50	14.50
DISTANZE PARZIALI [m]		5.00	2.25	2.25	5.00

Fosso del Tre Canali  
 SEZIONE N° 00091PB06

LEGENDA:

- TR30 H = 4.63 m. s.l.m.
- TR200 H = 4.65 m. s.l.m.
- TR500 H = 4.65 m. s.l.m.

SCALA DISTANZE 1:100  
 SCALA QUOTE 1:100

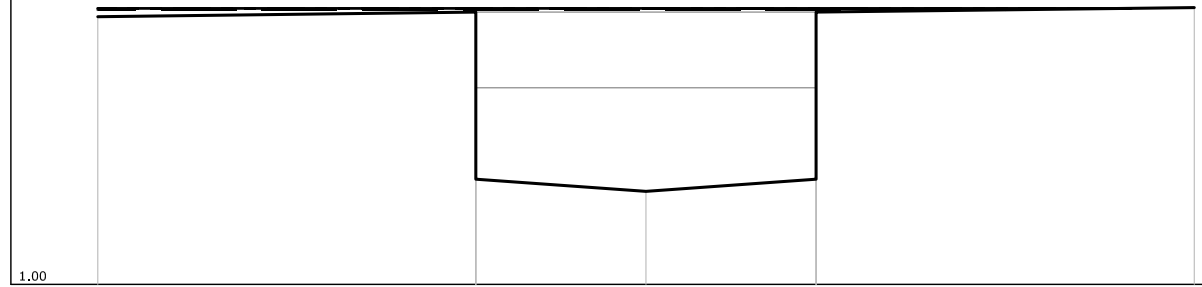

PUNTI	1	2	5	6	9
QUOTE [m s.l.m.]	4.54	4.60	2.23	2.39	4.66
DISTANZE PROGRESSIVE [m]	0.00	5.00	7.25	9.50	14.50
DISTANZE PARZIALI [m]		5.00	2.25	2.25	5.00

Fosso del Tre Canali  
 SEZIONE N° 00091PC06

LEGENDA:

- TR30 H = 4.38 m. s.l.m.
- TR200 H = 4.39 m. s.l.m.
- TR500 H = 4.39 m. s.l.m.

SCALA DISTANZE 1:100  
 SCALA QUOTE 1:100

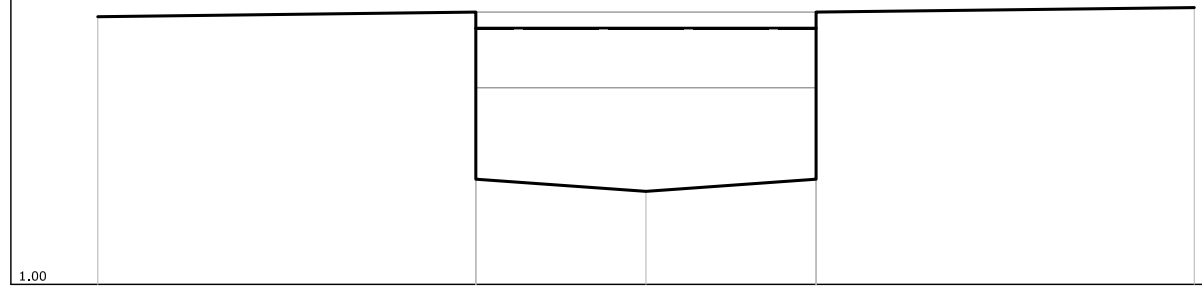

PUNTI	1	2	5	6	9
QUOTE [m s.l.m.]	4.54	4.60	2.23	2.39	4.66
DISTANZE PROGRESSIVE [m]	0.00	5.00	7.25	9.50	14.50
DISTANZE PARZIALI [m]		5.00	2.25	2.25	5.00

Fosso del Tre Canali  
 SEZIONE N° 00091PD06

LEGENDA:

- TR30 H = 4.38 m. s.l.m.
- TR200 H = 4.38 m. s.l.m.
- TR500 H = 4.39 m. s.l.m.

SCALA DISTANZE 1:100  
 SCALA QUOTE 1:100

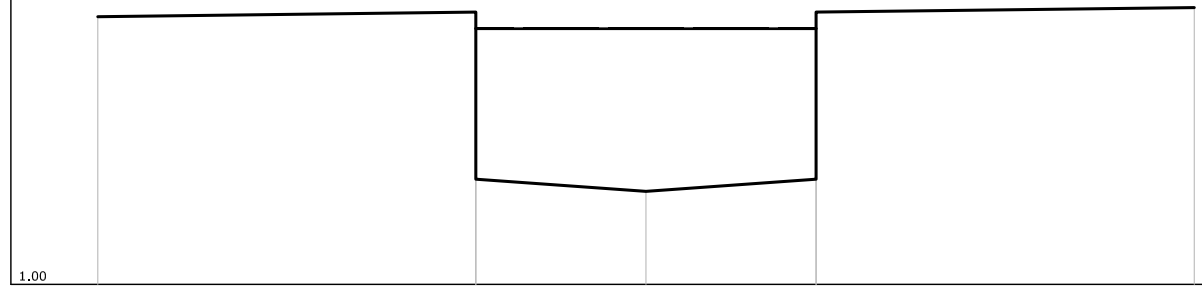

PUNTI	1	2	4	5	7
QUOTE [m s.l.m.]	4.54	4.60	2.23	2.39	4.66
DISTANZE PROGRESSIVE [m]	0.00	5.00	7.25	9.50	14.50
DISTANZE PARZIALI [m]		5.00	2.25	2.25	5.00

Fosso del Tre Canali  
 SEZIONE N° 00089\_\_06

LEGENDA:

TR30 H = 4.30 m. s.l.m. \_\_\_\_\_

TR200 H = 4.30 m. s.l.m. \_\_\_\_\_

TR500 H = 4.31 m. s.l.m. - - - - -

SCALA DISTANZE 1:100  
 SCALA QUOTE 1:100

1.00

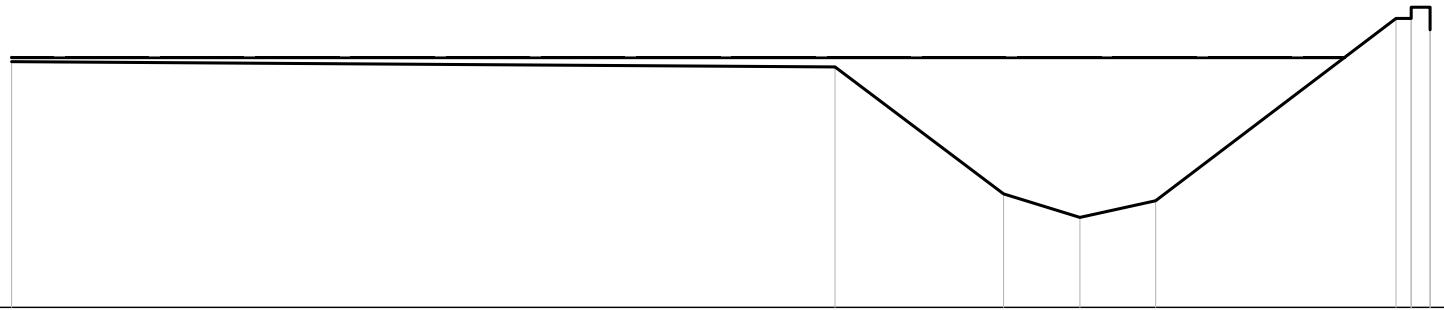

PUNTI	1		2	3	4	5		6	7	9
QUOTE [m s.l.m.]	4.25		4.18	2.50	2.19	2.41		4.82	4.82	4.97
DISTANZE PROGRESSIVE [m]	0.00		10.89	13.12	14.13	15.13		18.31	18.51	18.76
DISTANZE PARZIALI [m]		10.89		2.23	1.01	1.00	3.18			

Fosso del Tre Canali  
 SEZIONE N° 00084\_\_06

LEGENDA:

- TR30 H =4.10 m. s.l.m.
- TR200 H =4.10 m. s.l.m.
- TR500 H =4.10 m. s.l.m.

SCALA DISTANZE 1:100  
 SCALA QUOTE 1:100

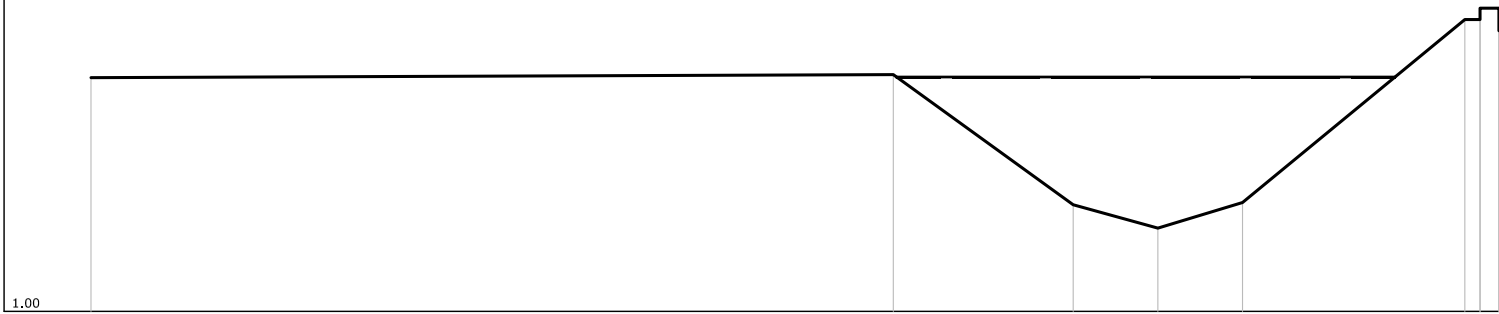

PUNTI	1	2	3	4	5	6	7	9
QUOTE [m s.l.m.]	4.09	4.13	2.41	2.10	2.44	4.86	4.86	5.01
DISTANZE PROGRESSIVE [m]	0.00	10.61	12.99	14.11	15.23	18.17	18.37	18.62
DISTANZE PARZIALI [m]		10.61	2.38	1.12	1.12	2.94		

Fosso del Tre Canali  
 SEZIONE N° 00078\_\_06

LEGENDA:

TR30 H = 3.91 m. s.l.m. ———

TR200 H = 3.91 m. s.l.m. ———

TR500 H = 3.92 m. s.l.m. - - - - -

SCALA DISTANZE 1:100  
 SCALA QUOTE 1:100

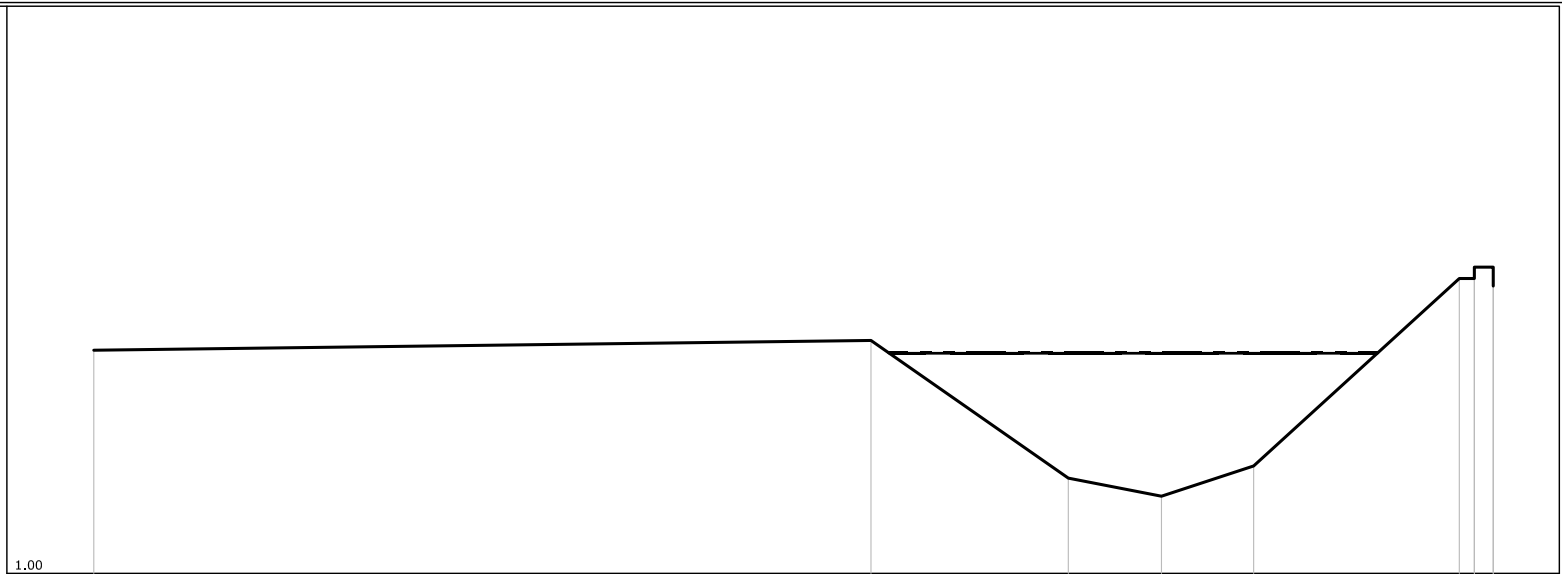

PUNTI	1	2	3	4	5	6	7	9
QUOTE [m s.l.m.]	3.95	4.08	2.26	2.02	2.42	4.90	4.90	5.05
DISTANZE PROGRESSIVE [m]	0.00	10.28	12.89	14.12	15.34	18.06	18.26	18.51
DISTANZE PARZIALI [m]		10.28	2.61	1.23	1.22	2.72		

Fosso del Tre Canal  
 SEZIONE N° 00073\_\_06

LEGENDA:

TR30 H = 3.73 m. s.l.m. ———

TR200 H = 3.73 m. s.l.m. ———

TR500 H = 3.73 m. s.l.m. - - - - -

SCALA DISTANZE 1:100  
 SCALA QUOTE 1:100

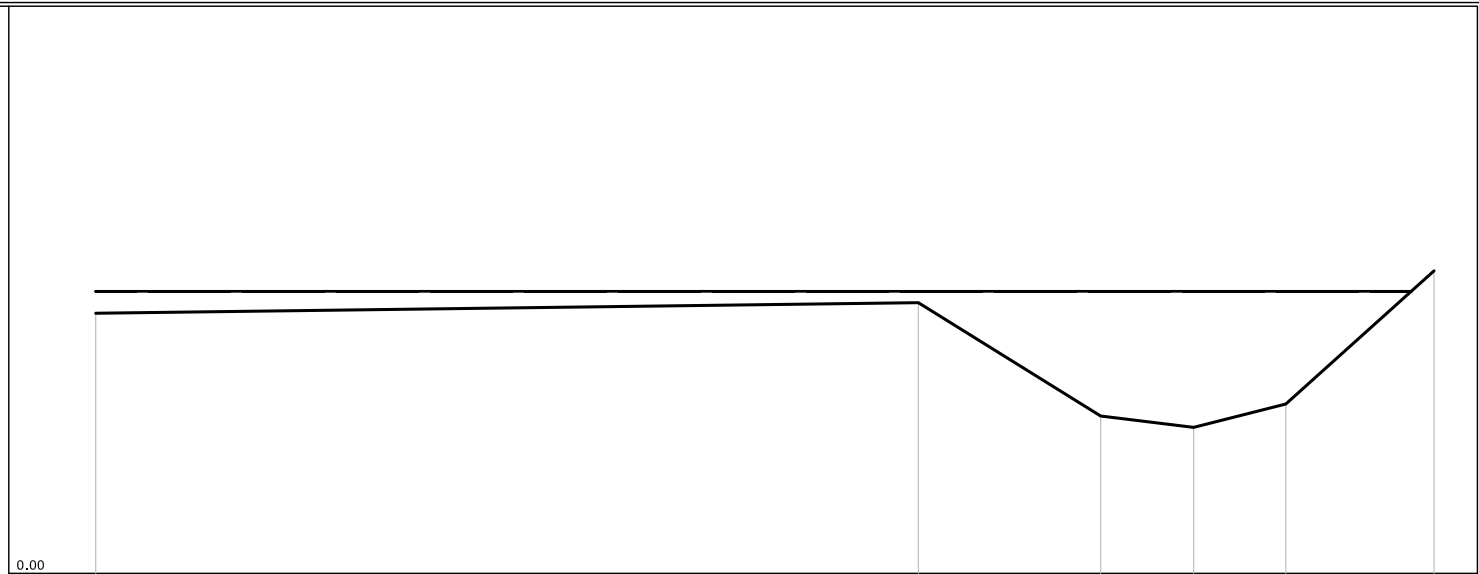

PUNTI	1	2	3	4	5	6
QUOTE [m s.l.m.]	3.44	3.58	2.08	1.93	2.24	4.00
DISTANZE PROGRESSIVE [m]	0.00	10.88	13.29	14.52	15.74	17.70
DISTANZE PARZIALI [m]		10.88	2.41	1.23	1.22	1.96



Fosso del Tre Canali  
 SEZIONE N° 00068\_\_06

LEGENDA:

- TR30 H = 3.62 m. s.l.m.
- TR200 H = 3.62 m. s.l.m.
- TR500 H = 3.62 m. s.l.m.

SCALA DISTANZE 1:100  
 SCALA QUOTE 1:100

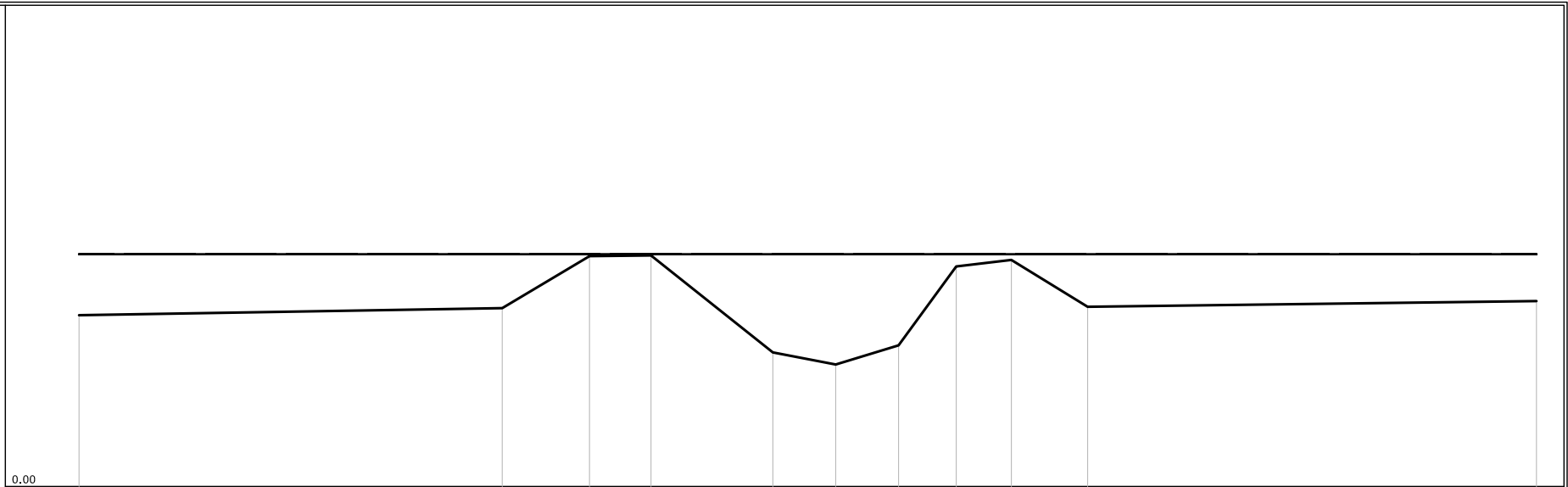

PUNTI	1	2	3	4	5	6	7	8	9	10	11
QUOTE [m s.l.m.]	2.67	2.78	3.59	3.60	2.09	1.90	2.20	3.43	3.53	2.80	2.89
DISTANZE PROGRESSIVE [m]	0.00	6.60	7.96	8.92	10.82	11.80	12.78	13.68	14.54	15.73	22.73
DISTANZE PARZIALI [m]		6.60	1.36	0.96	1.90	0.98	0.98	0.90	0.86	1.19	7.00

Fosso del Tre Canali  
 SEZIONE N° 00063\_\_06

LEGENDA:

TR30 H = 3.54 m. s.l.m. ———

TR200 H = 3.55 m. s.l.m. ———

TR500 H = 3.55 m. s.l.m. - - - - -

SCALA DISTANZE 1:100  
 SCALA QUOTE 1:100

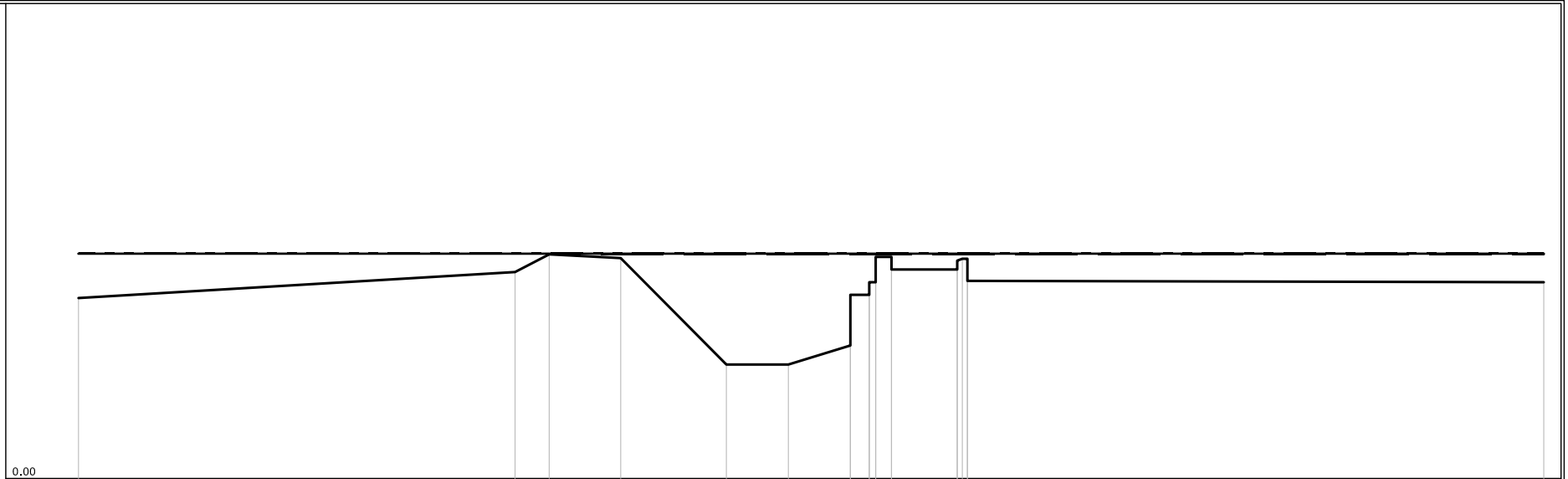

PUNTI	1	2	3	4	5	6	7	9	13	13.8	20	
QUOTE [m s.l.m.]	2.85	3.26	3.54	3.48	1.80	1.80	2.10	2.90	3.50	3.30	3.47	3.10
DISTANZE PROGRESSIVE [m]	0.00	6.90	7.44	8.57	10.24	11.22	12.20	12.50	12.85	13.89	14.05	23.16
DISTANZE PARZIALI [m]		6.90	0.54	1.13	1.67	0.98	0.98		1.04		9.11	

Fosso del Tre Canali  
 SEZIONE N° 00062PA06

LEGENDA:

TR30 H = 3.55 m. s.l.m. ———

TR200 H = 3.56 m. s.l.m. ———

TR500 H = 3.56 m. s.l.m. - - - - -

SCALA DISTANZE 1:100  
 SCALA QUOTE 1:100

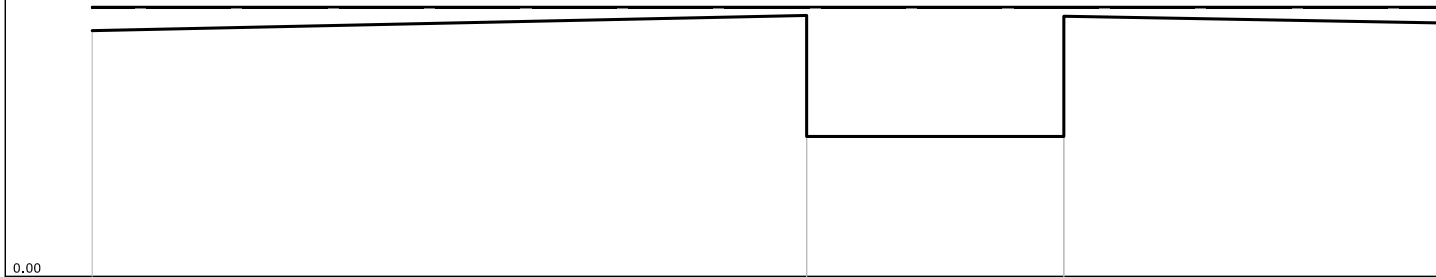

PUNTI	1	2	4	6
QUOTE [m s.l.m.]	3.25	3.45	1.85	3.35
DISTANZE PROGRESSIVE [m]	0.00	9.45	12.85	17.85
DISTANZE PARZIALI [m]		9.45	3.40	5.00

Fosso del Tre Canali  
 SEZIONE N° 00062PB06

LEGENDA:

TR30 H = 3.55 m. s.l.m. ———

TR200 H = 3.56 m. s.l.m. ———

TR500 H = 3.57 m. s.l.m. - - - - -

SCALA DISTANZE 1:100  
 SCALA QUOTE 1:100

0.00

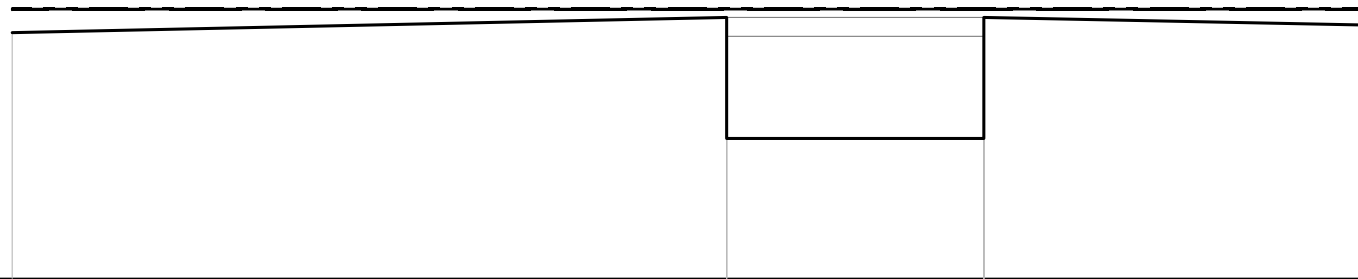

PUNTI	1	2	6	11
QUOTE [m s.l.m.]	3.25	3.45	1.85	3.35
DISTANZE PROGRESSIVE [m]	0.00	9.45	12.85	17.85
DISTANZE PARZIALI [m]		9.45	3.40	5.00

Fosso del Tre Canali  
 SEZIONE N° 00062PC06

LEGENDA:

TR30 H = 3.50 m. s.l.m. ———

TR200 H = 3.52 m. s.l.m. ———

TR500 H = 3.53 m. s.l.m. - - - - -

SCALA DISTANZE 1:100  
 SCALA QUOTE 1:100

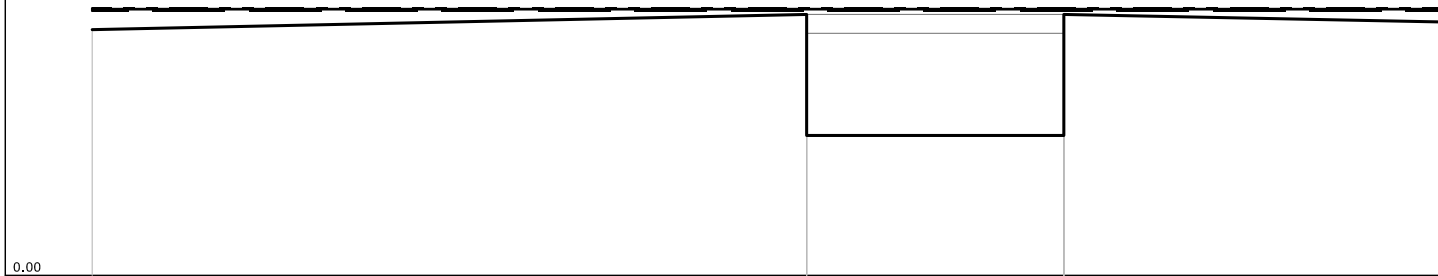

PUNTI	1	2	6	11
QUOTE [m s.l.m.]	3.25	3.45	1.85	3.35
DISTANZE PROGRESSIVE [m]	0.00	9.45	12.85	17.85
DISTANZE PARZIALI [m]		9.45	3.40	5.00

Fosso del Tre Canali  
 SEZIONE N° 00062PD06

LEGENDA:

TR30 H = 3.50 m. s.l.m. ———

TR200 H = 3.52 m. s.l.m. ———

TR500 H = 3.53 m. s.l.m. - - - - -

SCALA DISTANZE 1:100  
 SCALA QUOTE 1:100

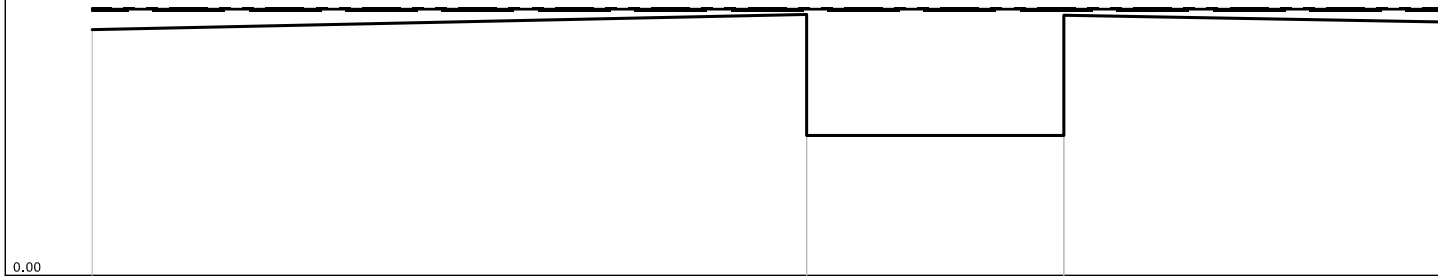

PUNTI	1	2	4	6
QUOTE [m s.l.m.]	3.25	3.45	1.85	3.35
DISTANZE PROGRESSIVE [m]	0.00	9.45	12.85	17.85
DISTANZE PARZIALI [m]		9.45	3.40	5.00

Fosso del Tre Canali  
 SEZIONE N° 00061\_\_06

LEGENDA:

TR30 H = 3.50 m. s.l.m. \_\_\_\_\_

TR200 H = 3.52 m. s.l.m. \_\_\_\_\_

TR500 H = 3.52 m. s.l.m. - - - - -

SCALA DISTANZE 1:100  
 SCALA QUOTE 1:100

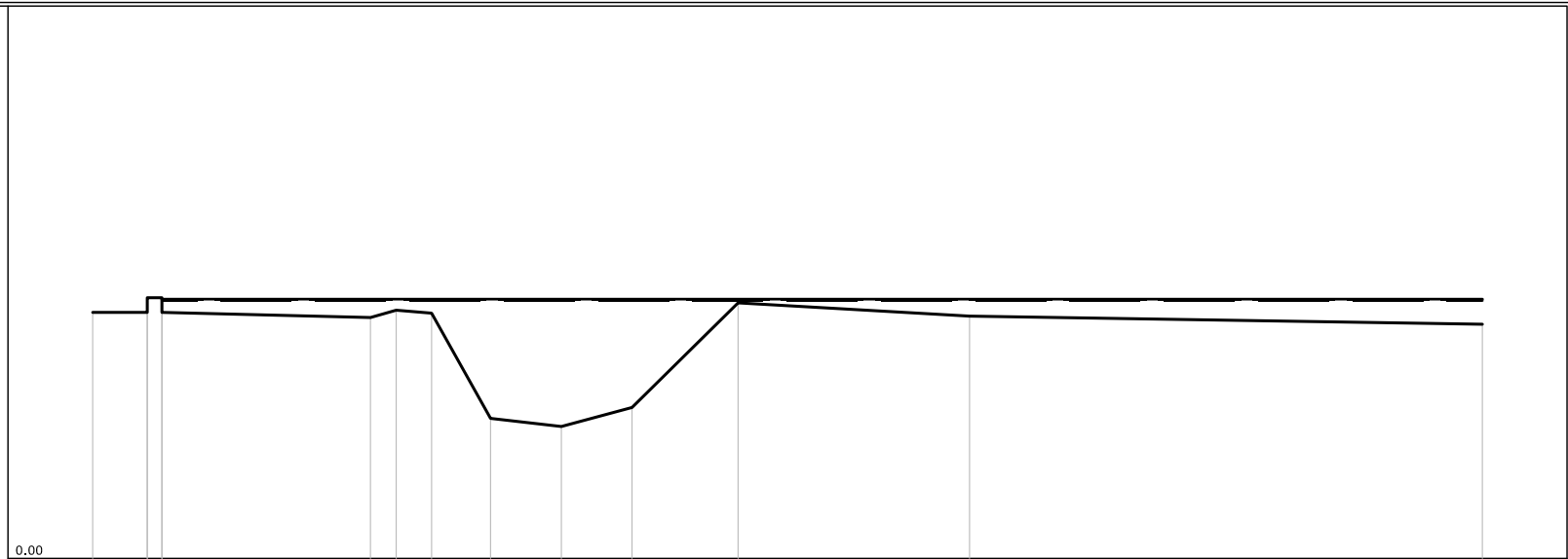



PUNTI	1	2	4	6	7	8	9	10	11	12	13	14
QUOTE [m s.l.m.]	3.34	3.34	3.54	3.27	3.37	3.33	1.90	1.79	2.05	3.47	3.29	3.18
DISTANZE PROGRESSIVE [m]	0.00	0.74	0.94	3.77	4.12	4.60	5.40	6.36	7.32	8.76	11.90	18.86
DISTANZE PARZIALI [m]	0.74		2.83		0.48	0.80	0.96	0.96	1.44	3.14		6.96

Fosso del Tre Canali  
 SEZIONE N° 00057\_\_06

LEGENDA:

TR30 H = 3.38 m. s.l.m. 

TR200 H = 3.44 m. s.l.m. 

TR500 H = 3.44 m. s.l.m. 

SCALA DISTANZE 1:100  
 SCALA QUOTE 1:100

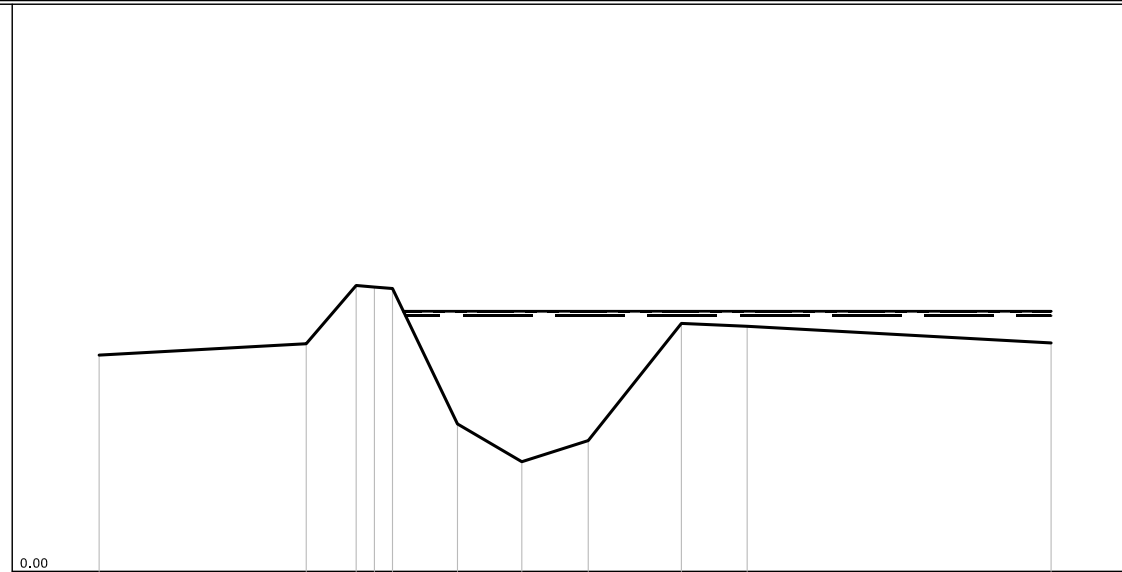

PUNTI	1	2	3	4	5	6	7	8	9	10	11
QUOTE [m s.l.m.]	2.86	3.01	3.78	3.76	3.74	1.95	1.45	1.73	3.28	3.24	3.02
DISTANZE PROGRESSIVE [m]	0.00	2.74	3.40	3.64	3.88	4.74	5.59	6.47	7.70	8.57	12.59
DISTANZE PARZIALI [m]		2.74	0.66			0.86	0.85	0.88	1.23	0.87	4.02



Fosso del Tre Canali  
 SEZIONE N° 00051\_\_06

LEGENDA:

TR30 H = 3.27 m. s.l.m. ———

TR200 H = 3.36 m. s.l.m. ———

TR500 H = 3.36 m. s.l.m. - - - - -

SCALA DISTANZE 1:100  
 SCALA QUOTE 1:100

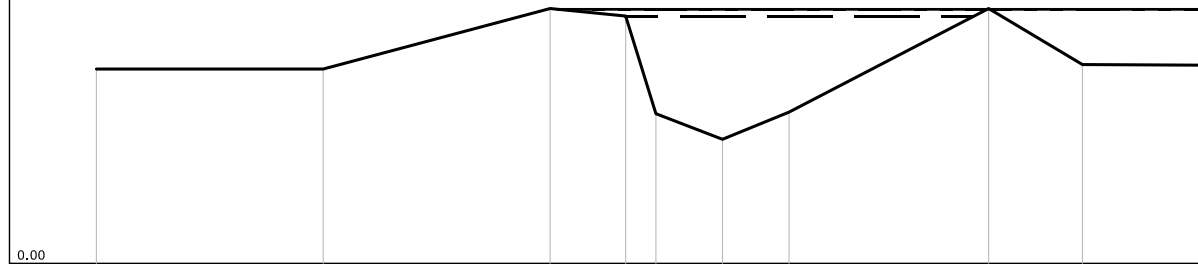

PUNTI	1	2	3	4	5	6	7	8	9	10
QUOTE [m s.l.m.]	2.57	2.57	3.37	3.27	1.98	1.64	2.00	3.37	2.63	2.62
DISTANZE PROGRESSIVE [m]	0.00	3.00	6.00	7.00	7.40	8.28	9.16	11.80	13.04	14.67
DISTANZE PARZIALI [m]		3.00	3.00	1.00	0.88	0.88	2.64	1.24	1.63	

Fosso del Tre Canali  
 SEZIONE N° 00043\_\_06

LEGENDA:

TR30 H = 3.16 m. s.l.m. \_\_\_\_\_

TR200 H = 3.25 m. s.l.m. \_\_\_\_\_

TR500 H = 3.26 m. s.l.m. \_\_\_\_\_

SCALA DISTANZE 1:100  
 SCALA QUOTE 1:100

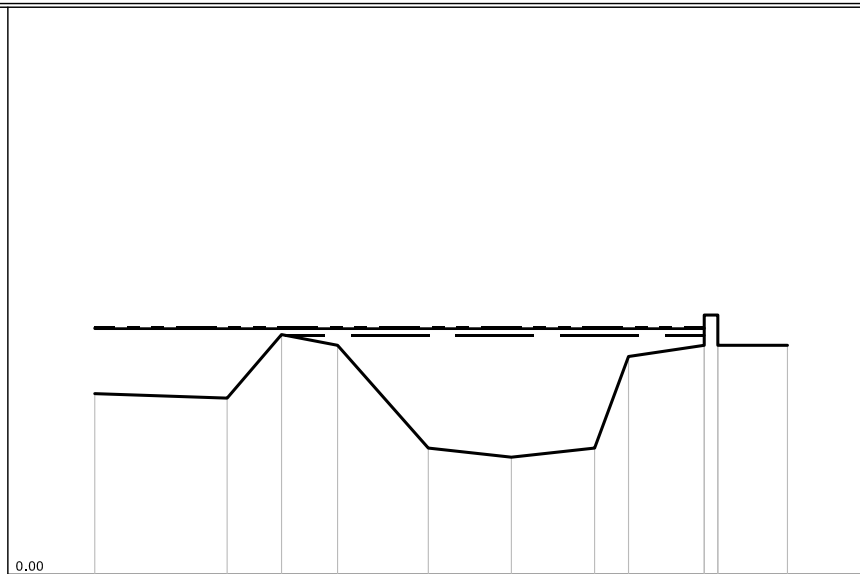

PUNTI	1	2	3	4	5	6	7	8	9	11	13
QUOTE [m s.l.m.]	2.39	2.33	3.17	3.03	1.67	1.55	1.67	2.88	3.03	3.43	3.03
DISTANZE PROGRESSIVE [m]	0.00	1.75	2.47	3.21	4.41	5.51	6.61	7.06	8.06	8.24	9.16
DISTANZE PARZIALI [m]		1.75	0.72	0.74	1.20	1.10	1.10		1.00		0.92

Fosso del Tre Canali  
 SEZIONE N° 00039\_\_06

LEGENDA:

- TR30 H =3.06 m. s.l.m.
- TR200 H =3.21 m. s.l.m.
- TR500 H =3.26 m. s.l.m.

SCALA DISTANZE 1:100  
 SCALA QUOTE 1:100

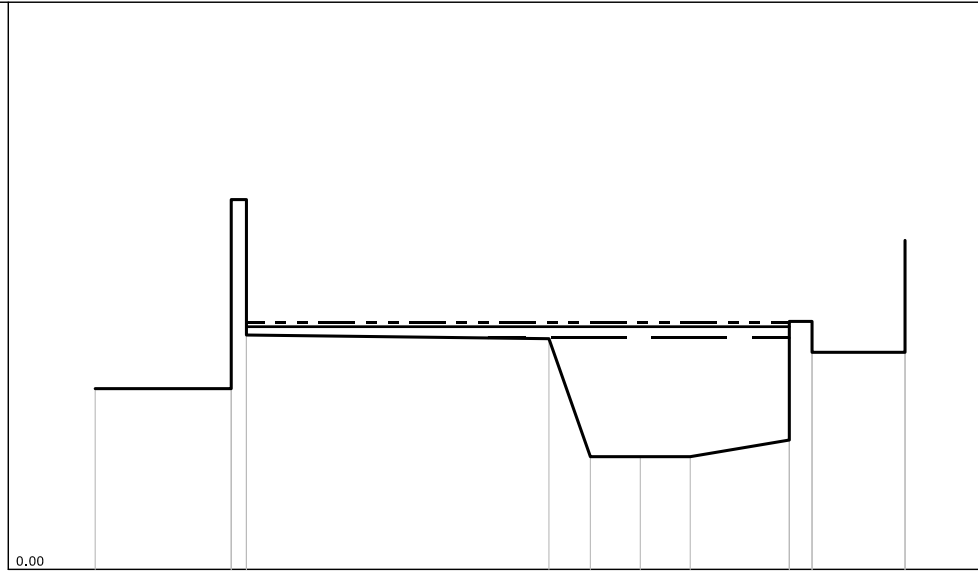

PUNTI	1	2	4	6	7	8	9	10	12	14
QUOTE [m s.l.m.]	2.39	2.39	4.89	3.05	1.49	1.49	1.49	1.71	3.28	2.87
DISTANZE PROGRESSIVE [m]	0.00	1.80	2.00	6.00	6.55	7.21	7.87	9.18	9.48	10.71
DISTANZE PARZIALI [m]		1.80		4.00	0.55	0.66	0.66	1.31		1.23

Fosso del Tre Canali  
 SEZIONE N° 00037PA06

LEGENDA:

TR30 H = 3.01 m. s.l.m. ———

TR200 H = 3.22 m. s.l.m. ———

TR500 H = 3.24 m. s.l.m. - - - - -

SCALA DISTANZE 1:100  
 SCALA QUOTE 1:100

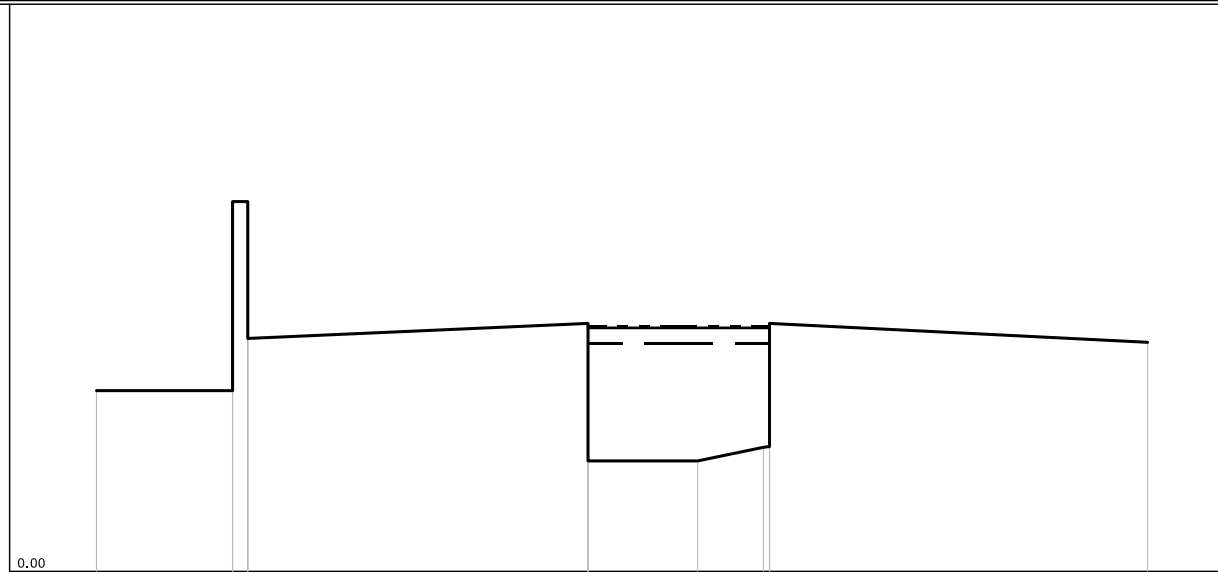

PUNTI	1	2	4	7	10	11	15
QUOTE [m s.l.m.]	2.39	2.39	4.89	3.28	1.46	1.64	3.03
DISTANZE PROGRESSIVE [m]	0.00	1.80	2.00	6.50	7.95	8.82	13.90
DISTANZE PARZIALI [m]		1.80		4.50	1.45	0.87	5.00

Fosso del Tre Canali  
 SEZIONE N° 00037PB06

LEGENDA:

TR30 H = 3.00 m. s.l.m. ———

TR200 H = 3.19 m. s.l.m. ———

TR500 H = 3.24 m. s.l.m. - - - - -

SCALA DISTANZE 1:100  
 SCALA QUOTE 1:100

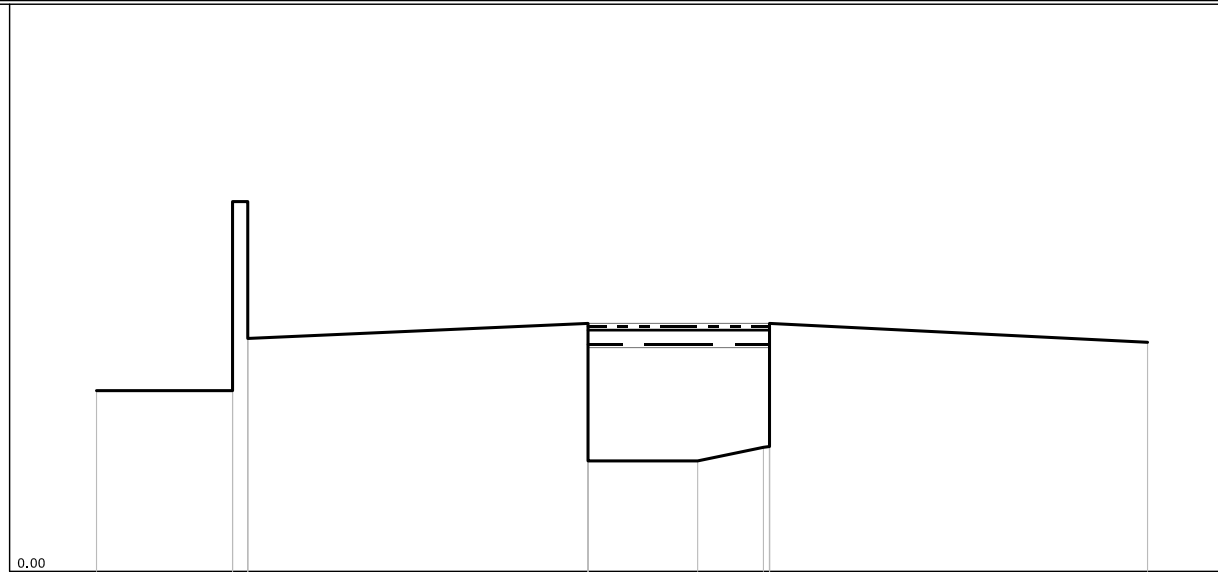

PUNTI	1	2	4	7	11	12	17
QUOTE [m s.l.m.]	2.39	2.39	4.89	3.28	1.46	1.64	3.03
DISTANZE PROGRESSIVE [m]	0.00	1.80	2.00	6.50	7.95	8.82	13.90
DISTANZE PARZIALI [m]		1.80		4.50	1.45	0.87	5.00

Fosso del Tre Canali  
 SEZIONE N° 00037PC06

LEGENDA:

TR30 H = 2,96 m. s.l.m. ———

TR200 H = 3,18 m. s.l.m. ———

TR500 H = 3,21 m. s.l.m. - - - - -

SCALA DISTANZE 1:100  
 SCALA QUOTE 1:100

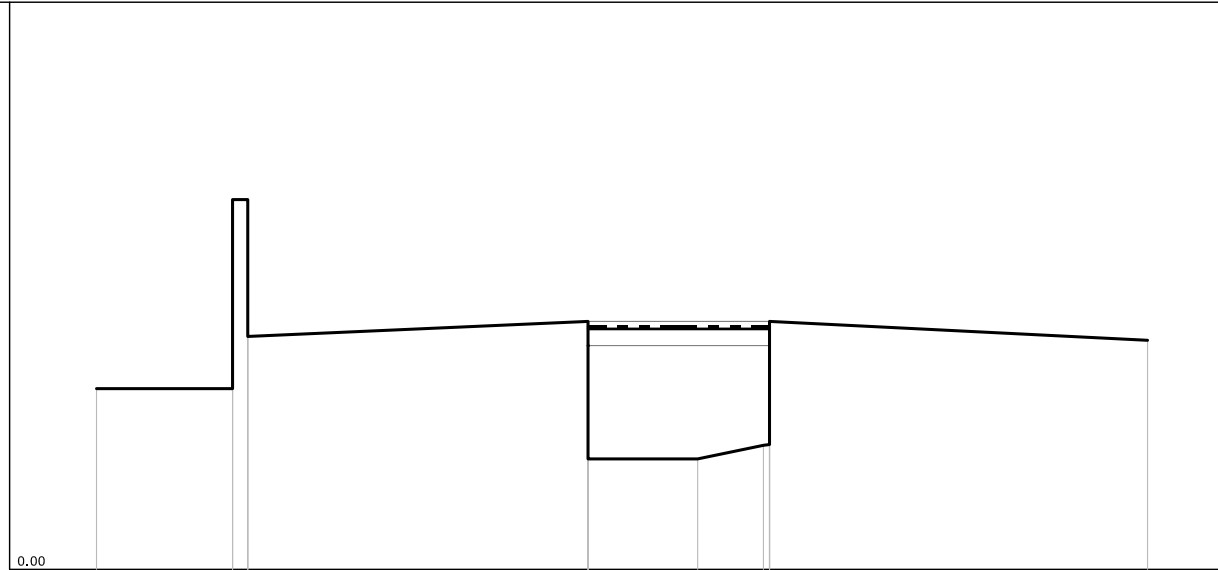

PUNTI	1	2	4	7	11	12	17
QUOTE [m s.l.m.]	2.39	2.39	4.89	3.28	1.46	1.64	3.03
DISTANZE PROGRESSIVE [m]	0.00	1.80	2.00	6.50	7.95	8.82	13.90
DISTANZE PARZIALI [m]		1.80		4.50	1.45	0.87	5.00

Fosso del Tre Canali  
 SEZIONE N° 00037PD06

LEGENDA:

TR30 H = 2,96 m. s.l.m. ———

TR200 H = 3,20 m. s.l.m. ———

TR500 H = 3,20 m. s.l.m. - - - - -

SCALA DISTANZE 1:100  
 SCALA QUOTE 1:100

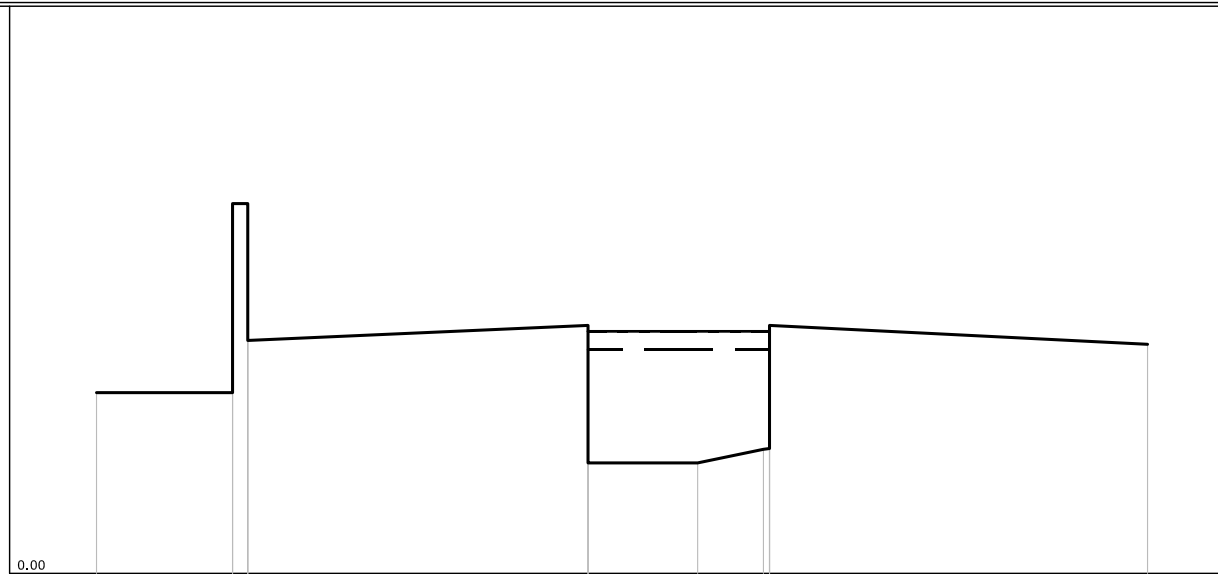

PUNTI	1	2	4	7	10	11	15
QUOTE [m s.l.m.]	2.39	2.39	4.89	3.28	1.46	1.64	3.03
DISTANZE PROGRESSIVE [m]	0.00	1.80	2.00	6.50	7.95	8.82	13.90
DISTANZE PARZIALI [m]		1.80		4.50	1.45	0.87	5.00

Fosso del Tre Canali  
 SEZIONE N° 00035\_\_06

LEGENDA:

- TR30 H = 3.00 m. s.l.m.
- TR200 H = 3.17 m. s.l.m.
- TR500 H = 3.20 m. s.l.m.

SCALA DISTANZE 1:100  
 SCALA QUOTE 1:100

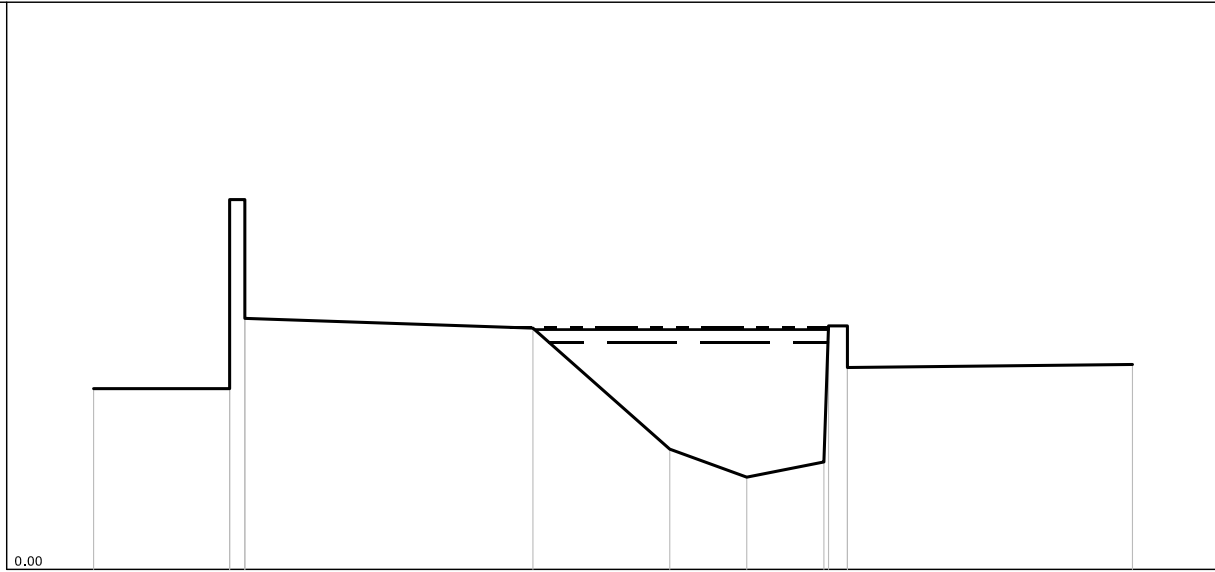



PUNTI	1	2	4	6	7	8	9	11	13
QUOTE [m s.l.m.]	2.39	2.39	4.89	3.19	1.59	1.22	1.42	3.22	2.71
DISTANZE PROGRESSIVE [m]	0.00	1.80	2.00	5.81	7.62	8.64	9.66	9.97	13.74
DISTANZE PARZIALI [m]		1.80		3.81	1.81	1.02	1.02		3.77



Fosso del Tre Canali  
 SEZIONE N° 00034\_\_06

LEGENDA:

TR30 H = 2,98 m. s.l.m. 

TR200 H = 3,09 m. s.l.m. 

TR500 H = 3,17 m. s.l.m. 

SCALA DISTANZE 1:100  
 SCALA QUOTE 1:100

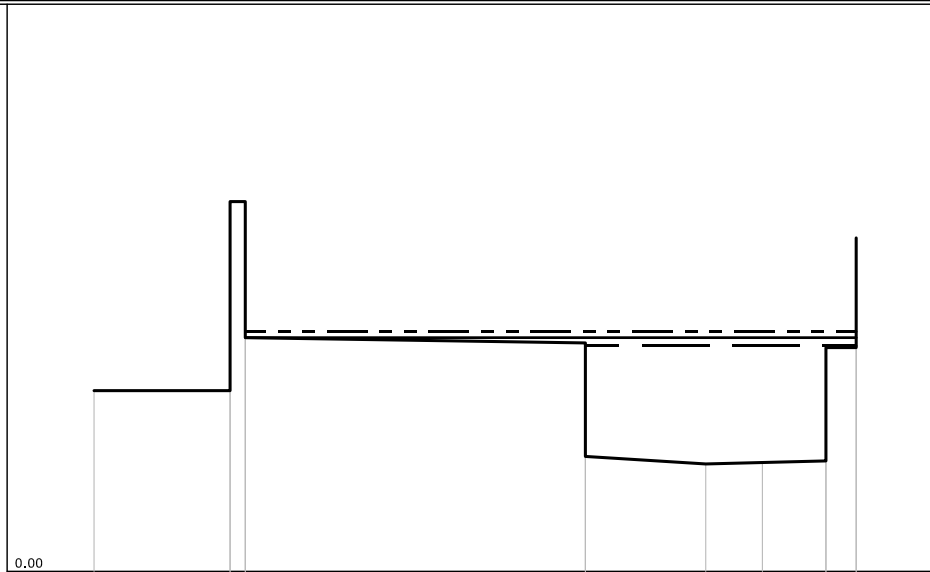



PUNTI	1	2	4	6	8	9	10	12
QUOTE [m s.l.m.]	2.39	2.39	4.89	3.02	1.42	1.44	1.46	2.96
DISTANZE PROGRESSIVE [m]	0.00	1.80	2.00	6.50	8.09	8.84	9.68	10.08
DISTANZE PARZIALI [m]		1.80		4.50	1.59	0.75	0.84	

Fosso del Tre Canali  
 SEZIONE N° 00033PA06

LEGENDA:

TR30 H = 3.11 m. s.l.m. 

TR200 H = 3.11 m. s.l.m. 

TR500 H = 3.13 m. s.l.m. 

SCALA DISTANZE 1:100  
 SCALA QUOTE 1:100

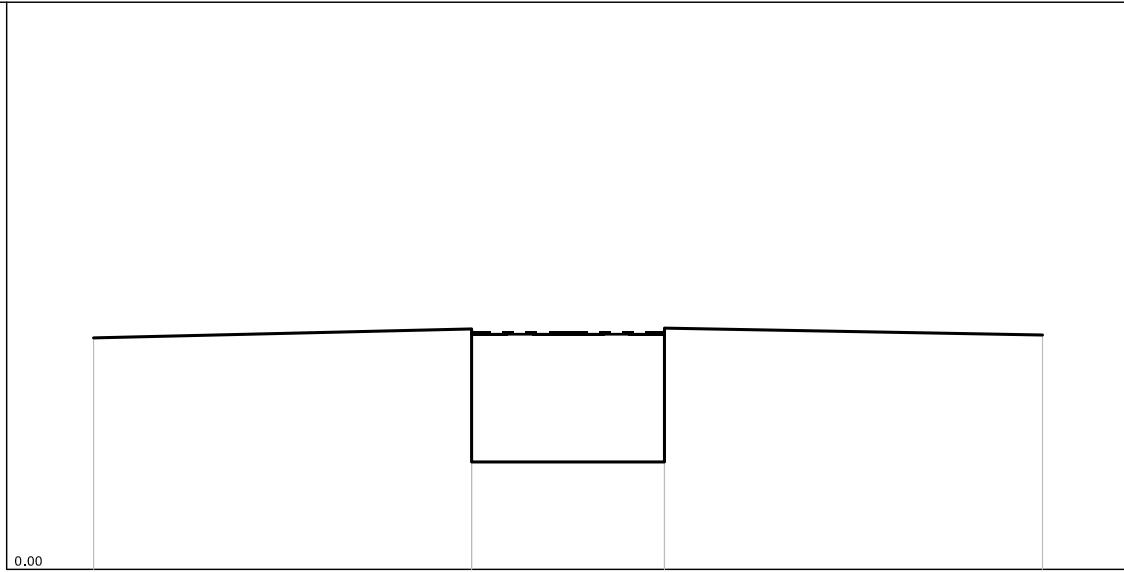



PUNTI	1	2	4	6
QUOTE [m s.l.m.]	3.06	3.18	1.42	3.10
DISTANZE PROGRESSIVE [m]	0.00	5.00	7.55	12.55
DISTANZE PARZIALI [m]		5.00	2.55	5.00

Fosso del Tre Canali  
 SEZIONE N° 00033PB06

LEGENDA:

TR30 H = 3.04 m. s.l.m. 

TR200 H = 3.06 m. s.l.m. 

TR500 H = 3.13 m. s.l.m. 

SCALA DISTANZE 1:100  
 SCALA QUOTE 1:100

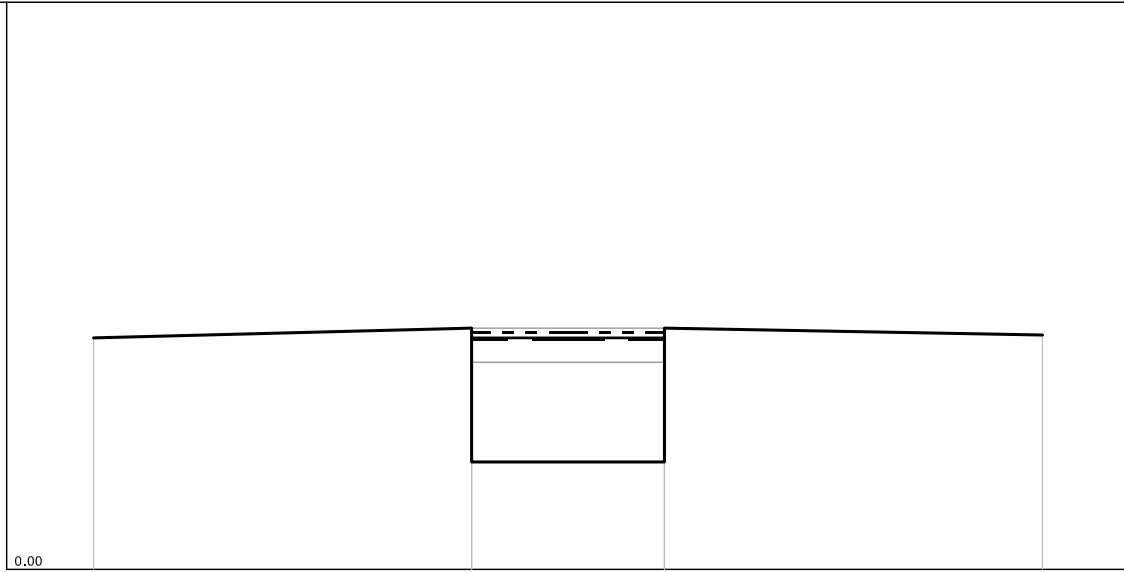



PUNTI	1	2	5	8
QUOTE [m s.l.m.]	3.06	3.19	1.42	3.10
DISTANZE PROGRESSIVE [m]	0.00	5.00	7.55	12.55
DISTANZE PARZIALI [m]		5.00	2.55	5.00

Fosso del Tre Canali  
 SEZIONE N° 00033PC06

LEGENDA:

TR30 H = 3.06 m. s.l.m. 

TR200 H = 3.06 m. s.l.m. 

TR500 H = 3.10 m. s.l.m. 

SCALA DISTANZE 1:100  
 SCALA QUOTE 1:100

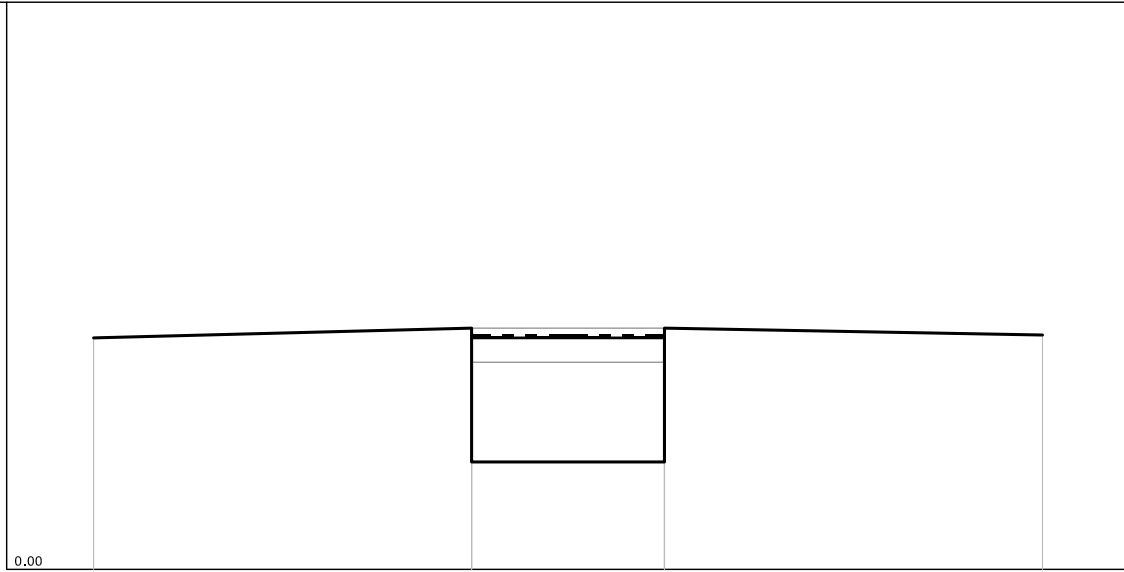

PUNTI	1	2	5	8
QUOTE [m s.l.m.]	3.06	3.19	1.42	3.10
DISTANZE PROGRESSIVE [m]	0.00	5.00	7.55	12.55
DISTANZE PARZIALI [m]		5.00	2.55	5.00

Fosso del Tre Canali  
 SEZIONE N° 00033PD06

LEGENDA:

TR30 H = 3.04 m. s.l.m. \_\_\_\_\_

TR200 H = 3.04 m. s.l.m. \_\_\_\_\_

TR500 H = 3.09 m. s.l.m. - - - - -

SCALA DISTANZE 1:100  
 SCALA QUOTE 1:100

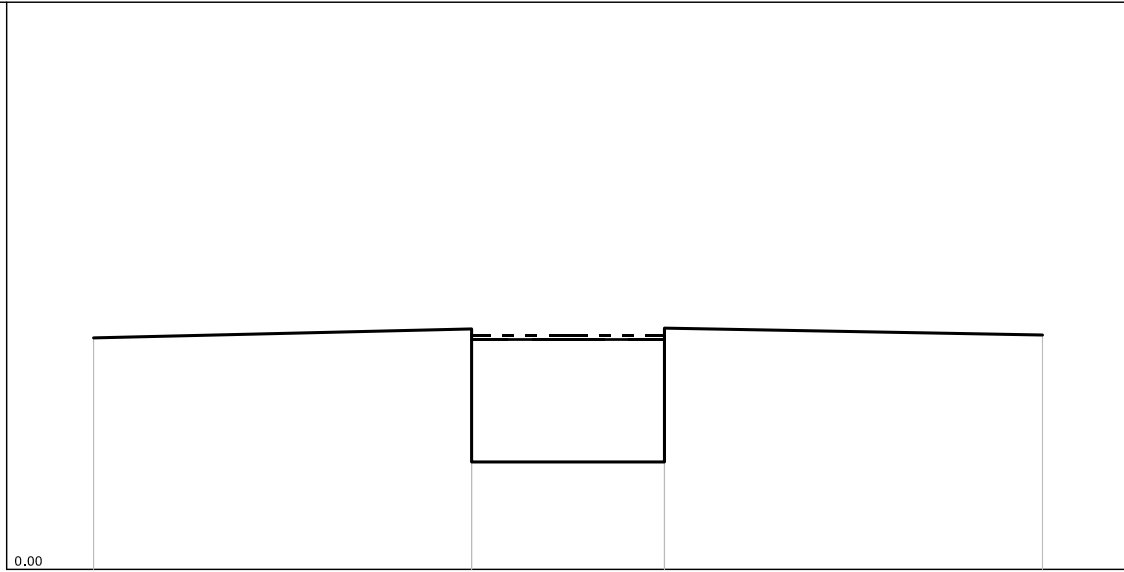

PUNTI	1	2	4	6
QUOTE [m s.l.m.]	3.06	3.18	1.42	3.10
DISTANZE PROGRESSIVE [m]	0.00	5.00	7.55	12.55
DISTANZE PARZIALI [m]		5.00	2.55	5.00

Fosso del Tre Canali  
 SEZIONE N° 00031\_06

LEGENDA:

- TR30 H = 2.88 m. s.l.m.
- TR200 H = 2.99 m. s.l.m.
- TR500 H = 3.10 m. s.l.m.

SCALA DISTANZE 1:100  
 SCALA QUOTE 1:100

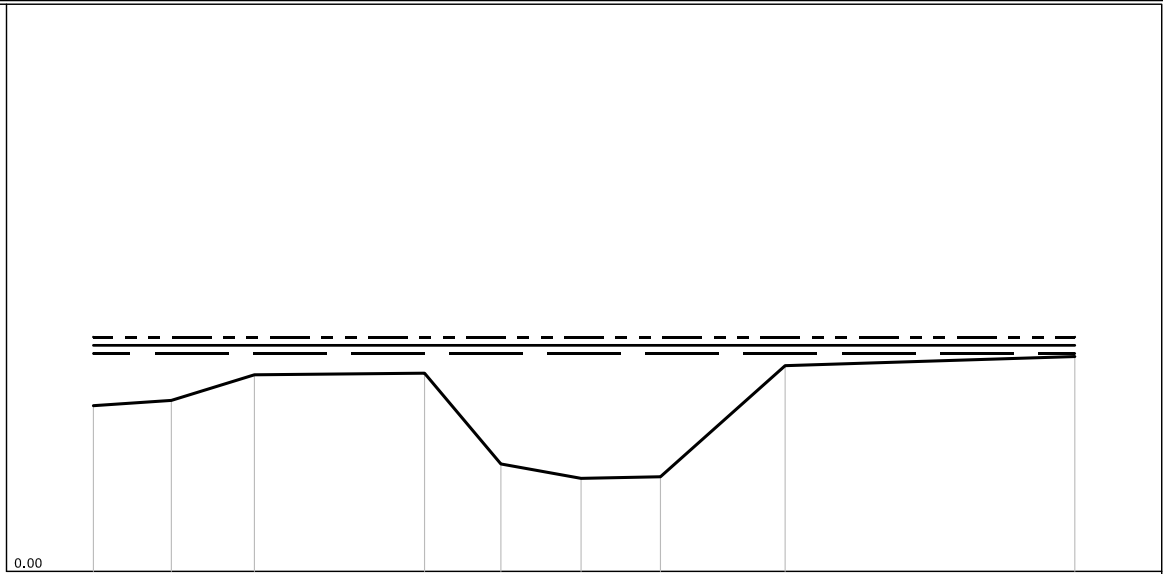

PUNTI	1	2	3	4	5	6	7	8	9
QUOTE [m s.l.m.]	2.19	2.26	2.60	2.62	1.42	1.23	1.25	2.72	2.84
DISTANZE PROGRESSIVE [m]	0.00	1.03	2.13	4.38	5.39	6.45	7.50	9.15	12.98
DISTANZE PARZIALI [m]		1.03	1.10	2.25	1.01	1.06	1.05	1.65	3.83

Fosso del Tre Canali  
 SEZIONE N° 00027PA06

LEGENDA:

- TR30 H = 2.85 m. s.l.m.
- TR200 H = 3.01 m. s.l.m.
- TR500 H = 3.10 m. s.l.m.

SCALA DISTANZE 1:100  
 SCALA QUOTE 1:100

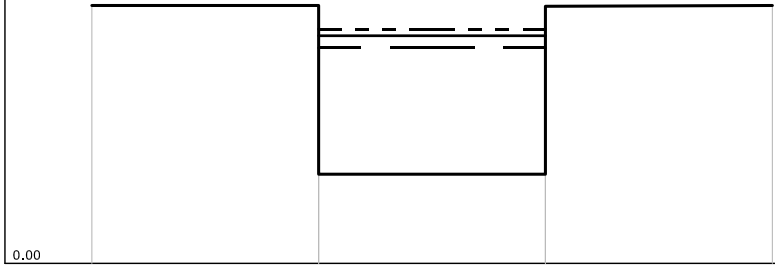

PUNTI	1	2	4	6
QUOTE [m s.l.m.]	3.41	3.41	1.18	3.41
DISTANZE PROGRESSIVE [m]	0.00	3.00	6.00	9.00
DISTANZE PARZIALI [m]		3.00	3.00	3.00

Fosso del Tre Canali  
 SEZIONE N° 00027PB06

LEGENDA:

TR30 H = 2.86 m. s.l.m. ————

TR200 H = 3.02 m. s.l.m. ————

TR500 H = 3.10 m. s.l.m. - - - - -

SCALA DISTANZE 1:100  
 SCALA QUOTE 1:100

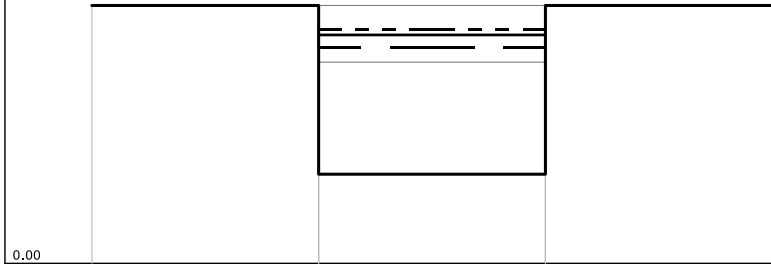

PUNTI	1	2	5	8
QUOTE [m s.l.m.]	3.41	3.41	1.18	3.41
DISTANZE PROGRESSIVE [m]	0.00	3.00	6.00	9.00
DISTANZE PARZIALI [m]		3.00	3.00	3.00



Fosso del Tre Canali  
 SEZIONE N° 00027PC06

LEGENDA:

TR30 H = 2.83 m. s.l.m. ————

TR200 H = 2.99 m. s.l.m. ————

TR500 H = 3.07 m. s.l.m. - - - - -

SCALA DISTANZE 1:100  
 SCALA QUOTE 1:100



PUNTI	1	2	5	8
QUOTE [m s.l.m.]	3.41	3.41	1.18	3.41
DISTANZE PROGRESSIVE [m]	0.00	3.00	6.00	9.00
DISTANZE PARZIALI [m]		3.00	3.00	3.00

Fosso del Tre Canali  
 SEZIONE N° 00027PD06

LEGENDA:

TR30 H = 2.83 m. s.l.m. ————

TR200 H = 3.00 m. s.l.m. ————

TR500 H = 3.07 m. s.l.m. - - - - -

SCALA DISTANZE 1:100  
 SCALA QUOTE 1:100

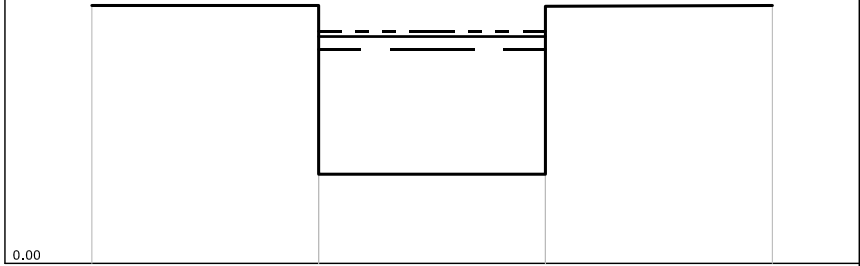

PUNTI	1	2	4	6
QUOTE [m s.l.m.]	3.41	3.41	1.18	3.41
DISTANZE PROGRESSIVE [m]	0.00	3.00	6.00	9.00
DISTANZE PARZIALI [m]		3.00	3.00	3.00

Fosso del Tre Canali  
 SEZIONE N° 00025\_06

LEGENDA:

- TR30 H = 2.82 m. s.l.m.
- TR200 H = 3.01 m. s.l.m.
- TR500 H = 3.07 m. s.l.m.

SCALA DISTANZE 1:100  
 SCALA QUOTE 1:100

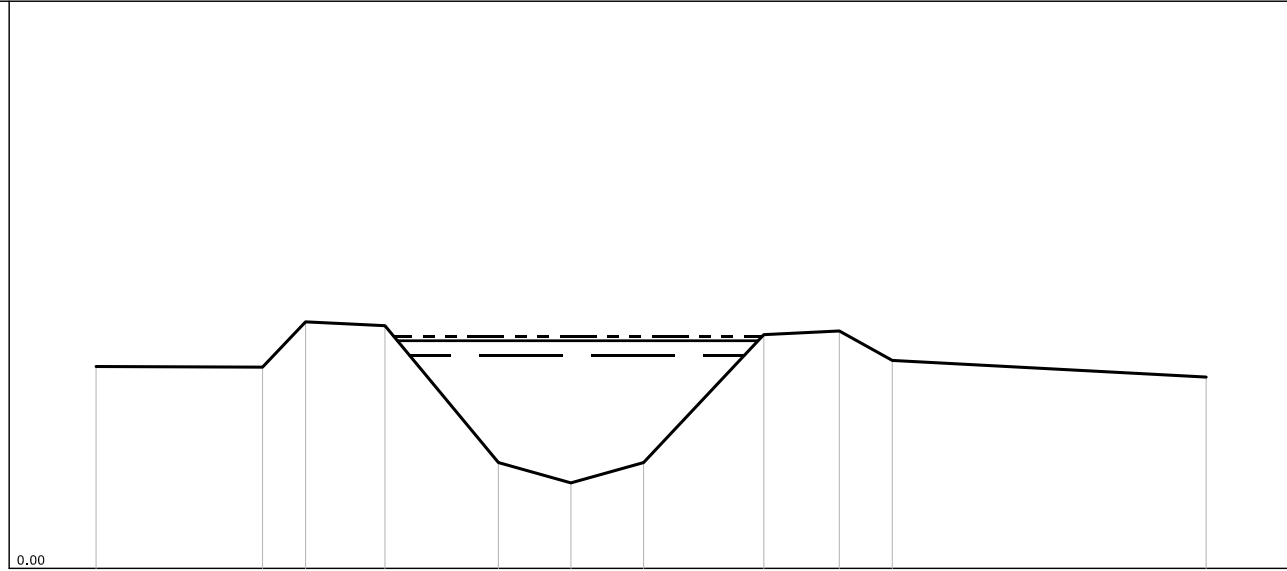

PUNTI	1	2	3	4	5	6	7	8	9	10	11
QUOTE [m s.l.m.]	2.67	2.66	3.26	3.21	1.40	1.13	1.40	3.09	3.14	2.75	2.53
DISTANZE PROGRESSIVE [m]	0.00	2.20	2.77	3.82	5.32	6.28	7.24	8.83	9.83	10.53	14.68
DISTANZE PARZIALI [m]		2.20	0.57	1.05	1.50	0.96	0.96	1.59	1.00	0.70	4.15

Fosso del Tre Canali  
 SEZIONE N° 00021\_\_06

LEGENDA:

TR30 H =2.77 m. s.l.m. \_\_\_\_\_

TR200 H =2.97 m. s.l.m. \_\_\_\_\_

TR500 H =3.07 m. s.l.m. \_\_\_\_\_

SCALA DISTANZE 1:100  
 SCALA QUOTE 1:100

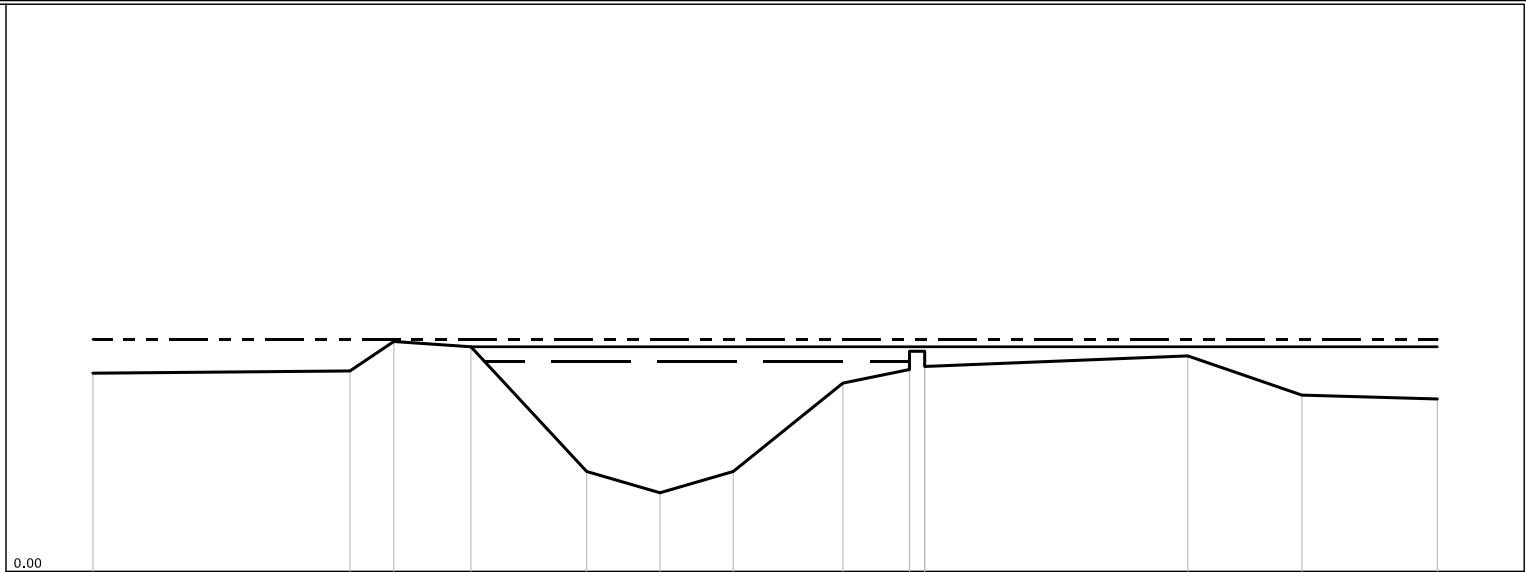

PUNTI	1	2	3	4	5	6	7	8	9	11	13	14	15
QUOTE [m s.l.m.]	2.62	2.65	3.04	2.97	1.32	1.04	1.32	2.49	2.67	2.91	2.85	2.33	2.28
DISTANZE PROGRESSIVE [m]	0.00	3.40	3.98	5.00	6.53	7.50	8.47	9.92	10.80	11.00	14.48	15.99	17.78
DISTANZE PARZIALI [m]		3.40	0.58	1.02	1.53	0.97	0.97	1.45	0.88		3.48	1.51	1.79

Fosso del Tre Canall  
 SEZIONE N° 00020PA06

LEGENDA:

TR30 H =2.77 m. s.l.m. ————

TR200 H =2.97 m. s.l.m. ————

TR500 H =3.07 m. s.l.m. - - - - -

SCALA DISTANZE 1:100  
 SCALA QUOTE 1:100

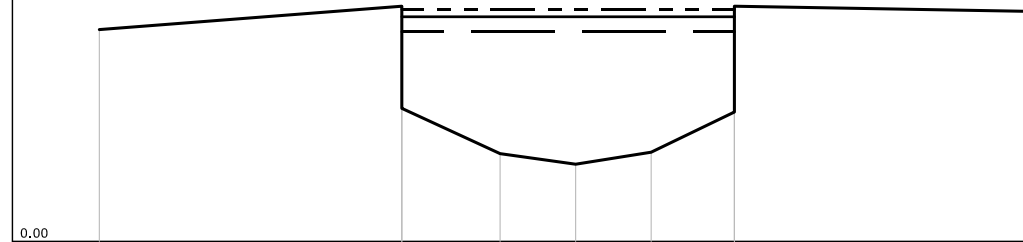

PUNTI	1	2	4	5	6	7	9
QUOTE [m s.l.m.]	2.80	3.11	1.16	1.02	1.18	1.71	3.04
DISTANZE PROGRESSIVE [m]	0.00	4.00	5.30	6.30	7.30	8.40	12.40
DISTANZE PARZIALI [m]		4.00	1.30	1.00	1.00	1.10	4.00

Fosso del Tre Canali  
 SEZIONE N° 00020PB06

LEGENDA:

TR30 H = 2.77 m. s.l.m. ———

TR200 H = 2.97 m. s.l.m. ———

TR500 H = 3.07 m. s.l.m. - - - - -

SCALA DISTANZE 1:100  
 SCALA QUOTE 1:100

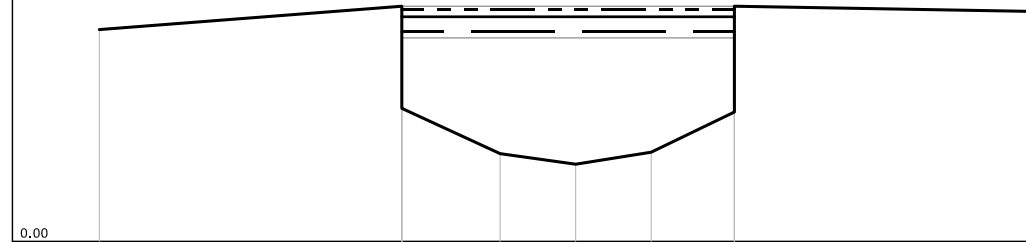

PUNTI	1	2	5	6	7	8	11
QUOTE [m s.l.m.]	2.80	3.11	1.16	1.02	1.18	1.71	3.04
DISTANZE PROGRESSIVE [m]	0.00	4.00	5.30	6.30	7.30	8.40	12.40
DISTANZE PARZIALI [m]		4.00	1.30	1.00	1.00	1.10	4.00

Fosso del Tre Canali  
 SEZIONE N° 00020PC06

LEGENDA:

- TR30 H = 2.74 m. s.l.m.
- TR200 H = 2.94 m. s.l.m.
- TR500 H = 3.04 m. s.l.m.

SCALA DISTANZE 1:100  
 SCALA QUOTE 1:100

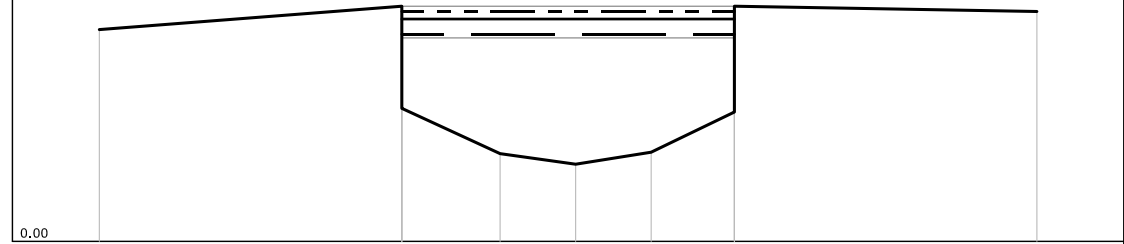

PUNTI	1	2	5	6	7	8	11
QUOTE [m s.l.m.]	2.80	3.11	1.16	1.02	1.18	1.71	3.04
DISTANZE PROGRESSIVE [m]	0.00	4.00	5.30	6.30	7.30	8.40	12.40
DISTANZE PARZIALI [m]		4.00	1.30	1.00	1.00	1.10	4.00

Fosso del Tre Canall  
 SEZIONE N° 00020PD06

LEGENDA:

TR30 H =2.74 m. s.l.m. ————

TR200 H =2.94 m. s.l.m. ————

TR500 H =3.04 m. s.l.m. - - - - -

SCALA DISTANZE 1:100  
 SCALA QUOTE 1:100

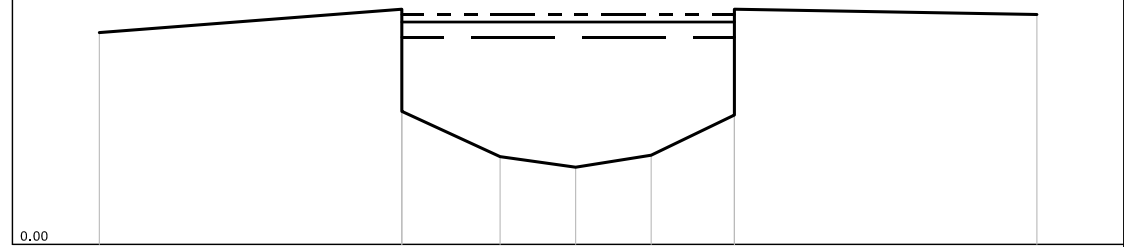



PUNTI	1	2	4	5	6	7	9
QUOTE [m s.l.m.]	2.80	3.11	1.16	1.02	1.18	1.71	3.04
DISTANZE PROGRESSIVE [m]	0.00	4.00	5.30	6.30	7.30	8.40	12.40
DISTANZE PARZIALI [m]		4.00	1.30	1.00	1.00	1.10	4.00



Fosso del Tre Canali  
SEZIONE N° 00019\_\_06

LEGENDA:

TR30 H = 2.73 m. s.l.m. 

TR200 H = 2.94 m. s.l.m. 

TR500 H = 3.04 m. s.l.m. 

SCALA DISTANZE 1:100  
SCALA QUOTE 1:100

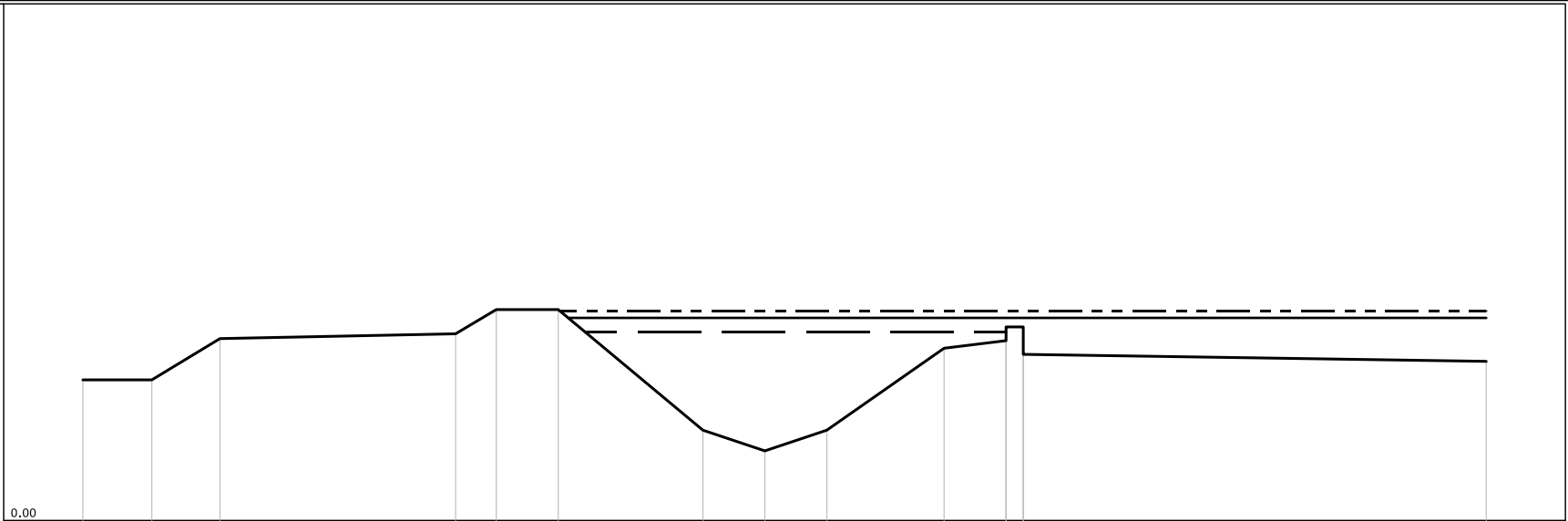

PUNTI	1	2	3	4	5	6	7	8	9	10	11	13	15
QUOTE [m s.l.m.]	2.04	2.04	2.64	2.71	3.06	3.06	1.31	1.01	1.31	2.50	2.61	2.81	2.31
DISTANZE PROGRESSIVE [m]	0.00	1.00	1.99	5.41	6.00	6.90	9.00	9.90	10.80	12.50	13.40	13.65	20.37
DISTANZE PARZIALI [m]		1.00	0.99	3.42	0.59	0.90	2.10	0.90	0.90	1.70	0.90	6.72	

Fosso del Tre Canali  
 SEZIONE N° 00015\_\_06

LEGENDA:

- TR30 H = 2.69 m. s.l.m.
- TR200 H = 2.92 m. s.l.m.
- TR500 H = 3.03 m. s.l.m.

SCALA DISTANZE 1:100  
 SCALA QUOTE 1:100

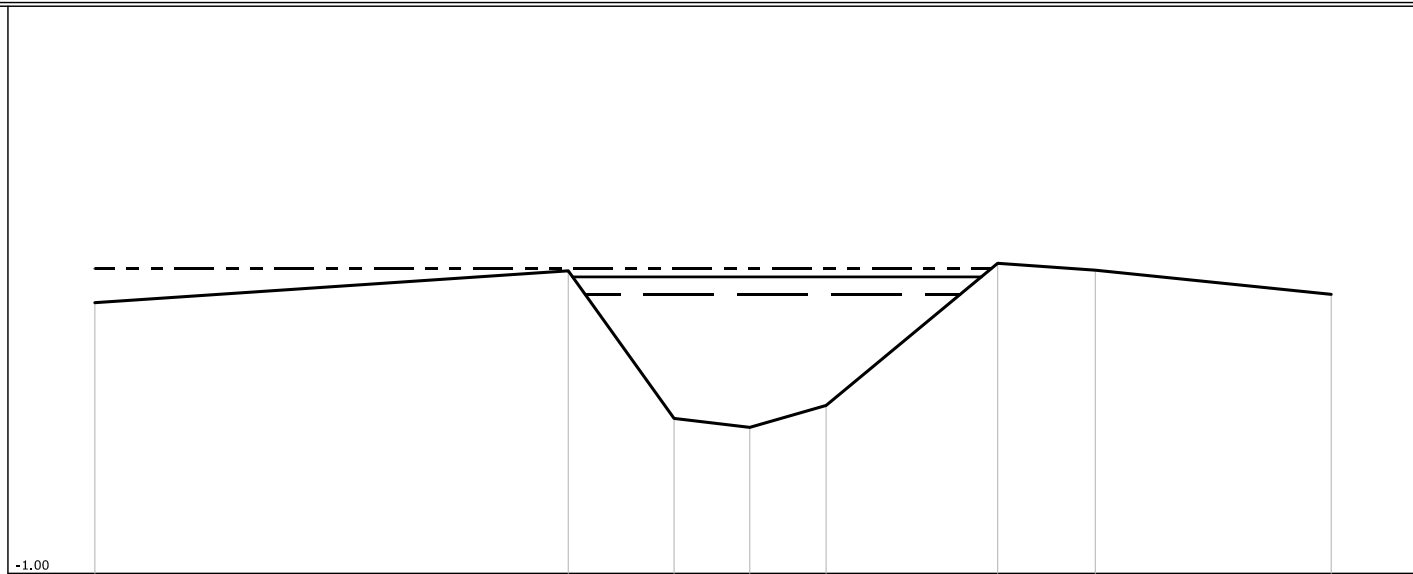

PUNTI	1	2	3	4	5	6	7	8
QUOTE [m s.l.m.]	2.58	3.00	1.05	0.93	1.22	3.10	3.01	2.69
DISTANZE PROGRESSIVE [m]	0.00	6.26	7.56	8.66	9.67	11.94	13.23	16.35
DISTANZE PARZIALI [m]		6.26	1.40	1.00	1.01	2.27	1.29	3.12

Fosso del Tre Canali  
 SEZIONE N° 00014PA06

LEGENDA:

TR30 H = 2.69 m. s.l.m. ———

TR200 H = 2.92 m. s.l.m. ———

TR500 H = 3.03 m. s.l.m. - - - - -

SCALA DISTANZE 1:100  
 SCALA QUOTE 1:100

-1.00

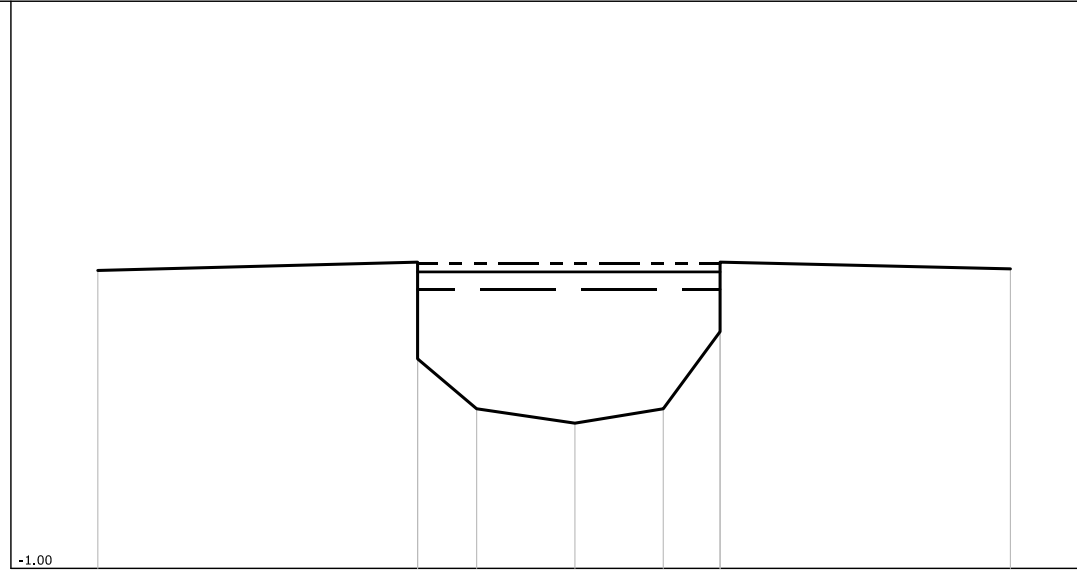



PUNTI	1	2	4	5	6	7	9
QUOTE [m s.l.m.]	2.94	3.05	1.11	0.92	1.11	2.13	2.96
DISTANZE PROGRESSIVE [m]	0.00	4.23	5.01	6.31	7.48	8.23	12.07
DISTANZE PARZIALI [m]		4.23	0.78	1.30	1.17	0.75	3.84

Fosso del Tre Canali  
 SEZIONE N° 00014PB06

LEGENDA:

TR30 H = 2.69 m. s.l.m. 

TR200 H = 2.92 m. s.l.m. 

TR500 H = 3.03 m. s.l.m. 

SCALA DISTANZE 1:100  
 SCALA QUOTE 1:100

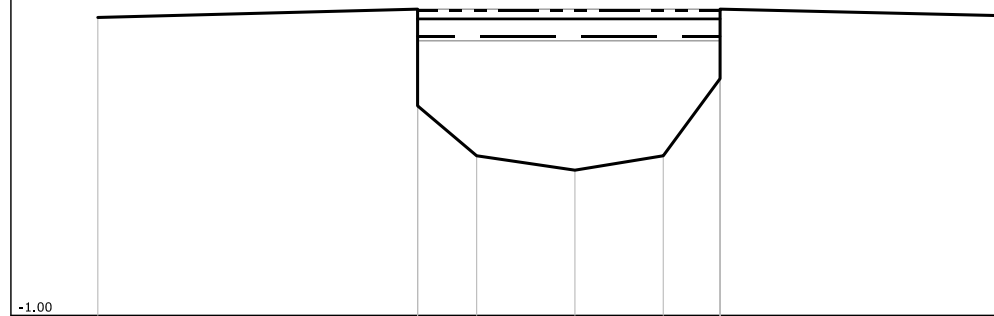

PUNTI	1	2	5	6	7	8	12
QUOTE [m s.l.m.]	2.94	3.05	1.11	0.92	1.11	2.13	2.96
DISTANZE PROGRESSIVE [m]	0.00	4.23	5.01	6.31	7.48	8.23	12.07
DISTANZE PARZIALI [m]		4.23	0.78	1.30	1.17	0.75	3.84

Fosso del Tre Canali  
 SEZIONE N° 00014PC06

LEGENDA:

TR30 H = 2.66 m. s.l.m. ———

TR200 H = 2.89 m. s.l.m. ———

TR500 H = 3.00 m. s.l.m. - - - - -

SCALA DISTANZE 1:100  
 SCALA QUOTE 1:100

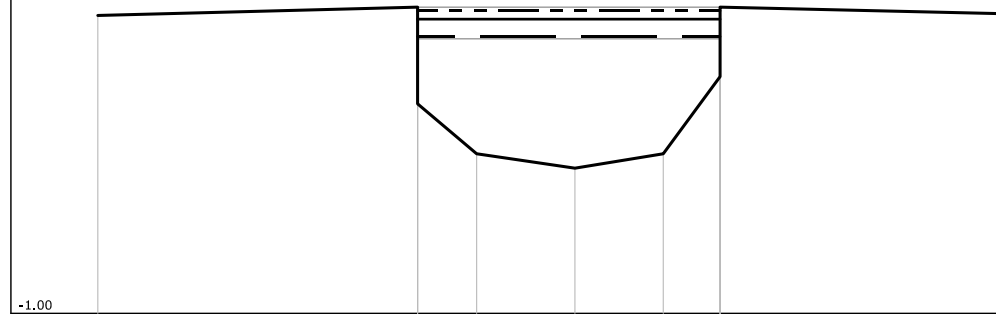

PUNTI	1	2	5	6	7	8	12
QUOTE [m s.l.m.]	2.94	3.05	1.11	0.92	1.11	2.13	2.96
DISTANZE PROGRESSIVE [m]	0.00	4.23	5.01	6.31	7.48	8.23	12.07
DISTANZE PARZIALI [m]		4.23	0.78	1.30	1.17	0.75	3.84

Fosso del Tre Canali  
 SEZIONE N° 00014PD06

LEGENDA:

TR30 H = 2.66 m. s.l.m. ———

TR200 H = 2.89 m. s.l.m. ———

TR500 H = 3.00 m. s.l.m. - - - - -

SCALA DISTANZE 1:100  
 SCALA QUOTE 1:100

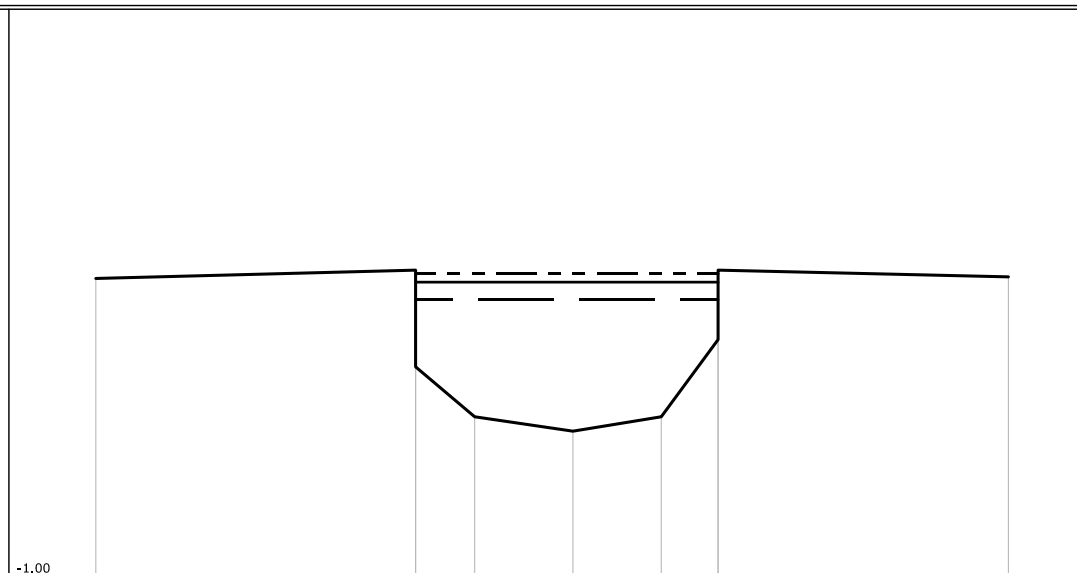

PUNTI	1	2	4	5	6	7	9
QUOTE [m s.l.m.]	2.94	3.05	1.11	0.92	1.11	2.13	2.96
DISTANZE PROGRESSIVE [m]	0.00	4.23	5.01	6.31	7.48	8.23	12.07
DISTANZE PARZIALI [m]		4.23	0.78	1.30	1.17	0.75	3.84

Fosso del Tre Canali  
 SEZIONE N° 00012\_\_06

LEGENDA:

TR30 H = 2.68 m. s.l.m. 

TR200 H = 2.90 m. s.l.m. 

TR500 H = 3.00 m. s.l.m. 

SCALA DISTANZE 1:100  
 SCALA QUOTE 1:100

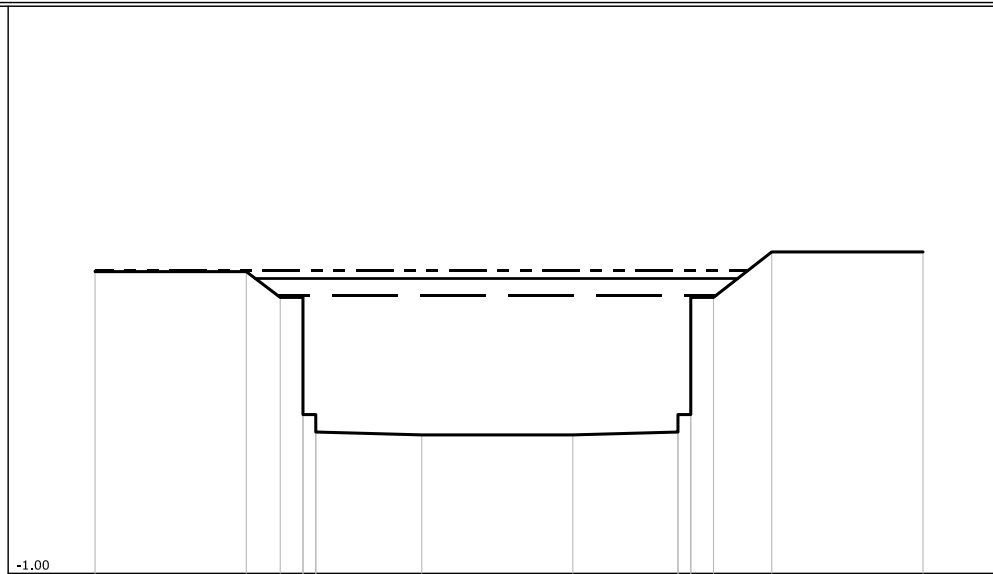

PUNTI	1	2	3	4	6	8	9	10	12	14	15	16
QUOTE [m s.l.m.]	2.99	2.99	2.65	2.65	1.10	0.83	0.83	0.87	1.10	2.65	3.25	3.25
DISTANZE PROGRESSIVE [m]	0.00	2.00	2.45	2.75	2.92	4.32	6.32	7.71	7.88	8.18	8.95	10.95
DISTANZE PARZIALI [m]		2.00				1.40	2.00	1.39			0.77	2.00

Fosso del Tre Canali  
 SEZIONE N° 00010PB06

LEGENDA:

- TR30 H = 2.68 m. s.l.m.
- TR200 H = 2.90 m. s.l.m.
- TR500 H = 3.00 m. s.l.m.

SCALA DISTANZE 1:100  
 SCALA QUOTE 1:100

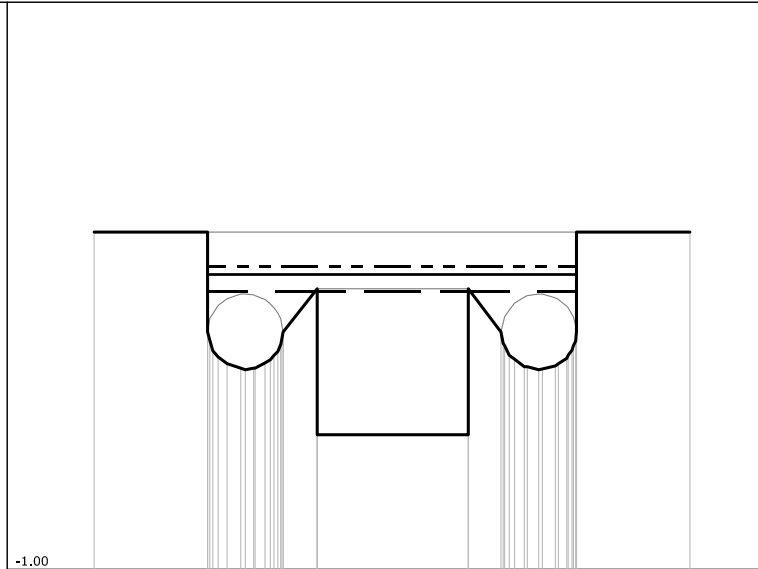

PUNTI	1	2	6	8	10	21	25	20	23	25	29	30	32	34	40	43
QUOTE [m s.l.m.]	3.46	3.46	1.81	1.66	1.66	1.73	1.88	2.71	0.78	2.14	1.68	1.64	1.69	1.70	3.46	
DISTANZE PROGRESSIVE [m]	0.00	1.50	1.64	1.94	2.11	2.36	2.43	2.95	4.95	5.38	5.78	5.88	6.10	6.37	7.88	
DISTANZE PARZIALI [m]		1.50						2.00							1.50	



Fosso del Tre Canali  
 SEZIONE N° 00010PC06

LEGENDA:

- TR30 H = 2.39 m. s.l.m.
- TR200 H = 2.73 m. s.l.m.
- TR500 H = 2.85 m. s.l.m.

SCALA DISTANZE 1:100  
 SCALA QUOTE 1:100

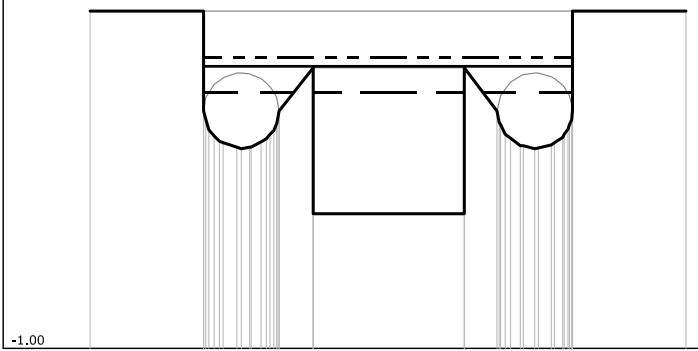

PUNTI	1	2	6	8	9	11	13	16	21	24	26	30	133	33	35	37	42	44
QUOTE [m s.l.m.]	3.46	3.46	1.81	1.72	1.66	1.73	1.88	2.71	0.78	2.14	1.68	1.64	1.69	1.75	3.46			
DISTANZE PROGRESSIVE [m]	0.00	1.50	1.64	1.76	2.11	2.36	2.43	2.95	4.95	5.38	5.70	5.88	6.10	6.33	7.88			
DISTANZE PARZIALI [m]		1.50						2.00							1.50			

Fosso del Tre Canali  
 SEZIONE N° 00007\_\_06

LEGENDA:

TR30 H = 2.39 m. s.l.m. ———

TR200 H = 2.72 m. s.l.m. ———

TR500 H = 2.85 m. s.l.m. - - - - -

SCALA DISTANZE 1:100  
 SCALA QUOTE 1:100

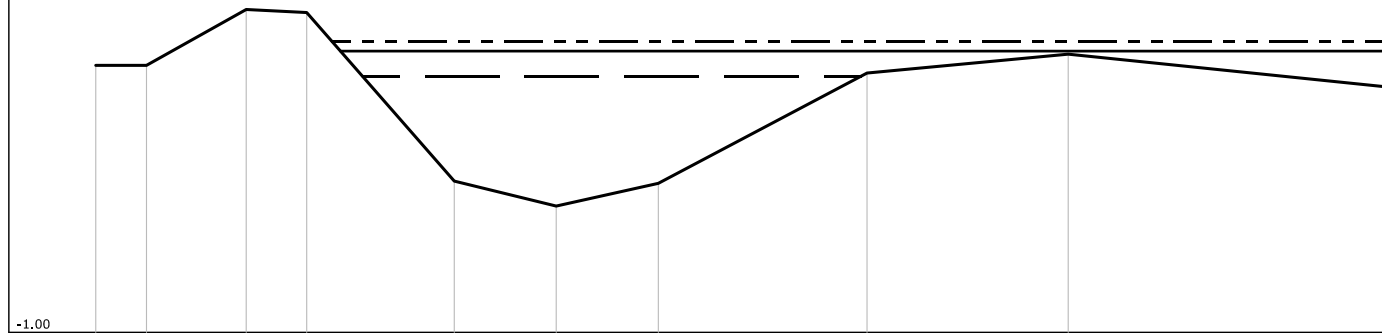

PUNTI	1	2	3	4	5	6	7	8	9	10
QUOTE [m s.l.m.]	2.53	2.53	3.27	3.23	1.00	0.67	0.97	2.43	2.68	2.25
DISTANZE PROGRESSIVE [m]	0.00	0.67	1.99	2.79	4.74	6.09	7.44	10.20	12.86	17.04
DISTANZE PARZIALI [m]		0.67	1.32	0.80	1.95	1.35	1.35	2.76	2.66	4.18

Canale di Bolfano

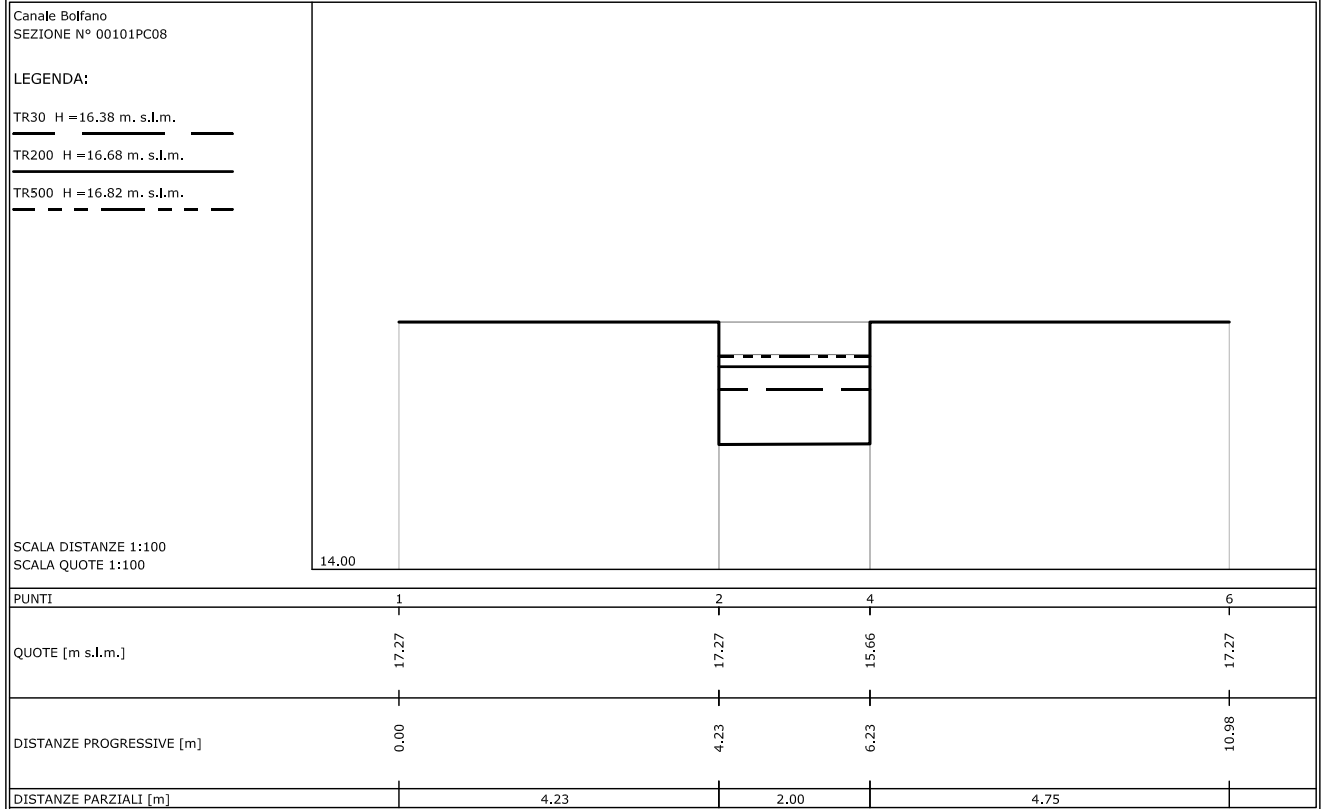

Canale Bolfano  
 SEZIONE N° 00101PD08

LEGENDA:

- TR30 H =16.27 m. s.l.m.
- TR200 H =16.57 m. s.l.m.
- TR500 H =16.71 m. s.l.m.

SCALA DISTANZE 1:100  
 SCALA QUOTE 1:100

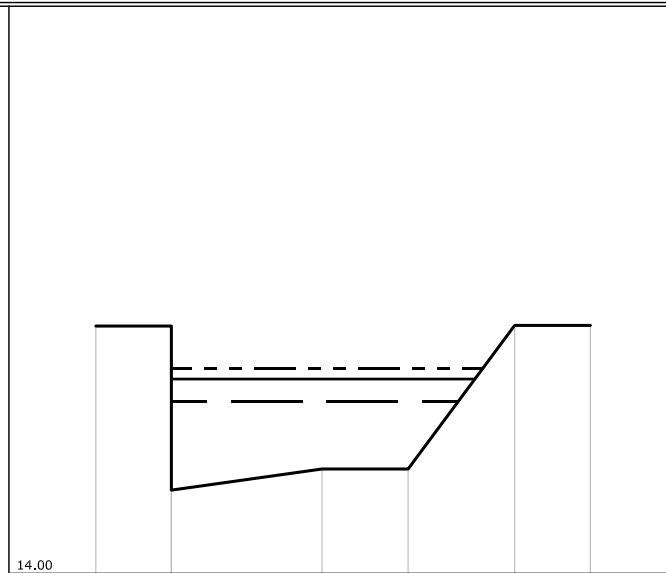

PUNTI	1	2	4	5	6	7
QUOTE [m s.l.m.]	17.27	17.27	15.38	15.38	17.28	17.28
DISTANZE PROGRESSIVE [m]	0.00	1.00	2.99	4.13	5.54	6.54
DISTANZE PARZIALI [m]		1.00	1.99	1.14	1.41	1.00

Canale Bolfano  
 SEZIONE N° 00080\_\_08

LEGENDA:

TR30 H = 13.52 m. s.l.m. \_\_\_\_\_

TR200 H = 13.66 m. s.l.m. \_\_\_\_\_

TR500 H = 13.73 m. s.l.m. - - - - -

SCALA DISTANZE 1:100  
 SCALA QUOTE 1:100

11.00

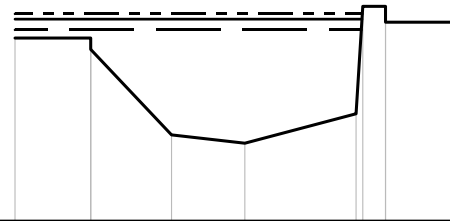



PUNTI	1	2	4	5	6	8	10
QUOTE [m s.l.m.]	13.41	13.41	12.13	12.02	12.41	13.83	13.62
DISTANZE PROGRESSIVE [m]	0.00	1.00	2.07	3.04	4.51	4.90	5.90
DISTANZE PARZIALI [m]		1.00	1.07	0.97	1.47		1.00

Canale Bolfano  
 SEZIONE N° 00079PA08

LEGENDA:

TR30 H = 13.54 m. s.l.m. 

TR200 H = 13.69 m. s.l.m. 

TR500 H = 13.74 m. s.l.m. 

SCALA DISTANZE 1:100  
 SCALA QUOTE 1:100

10.00

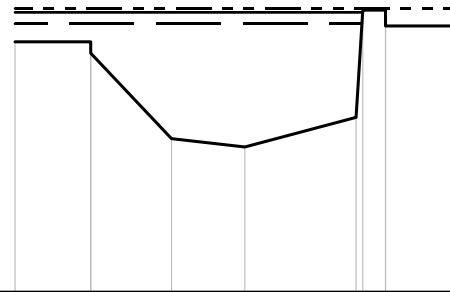



PUNTI	1	2	4	5	6	8	10
QUOTE [m s.l.m.]	13.30	13.30	12.02	11.91	12.30	13.72	13.51
DISTANZE PROGRESSIVE [m]	0.00	1.00	2.07	3.04	4.51	4.90	5.90
DISTANZE PARZIALI [m]		1.00	1.07	0.97	1.47		1.00

Canale Bolfano  
 SEZIONE N° 00079PB08

LEGENDA:

TR30 H = 13.51 m. s.l.m. 

TR200 H = 13.65 m. s.l.m. 

TR500 H = 13.71 m. s.l.m. 

SCALA DISTANZE 1:100  
 SCALA QUOTE 1:100

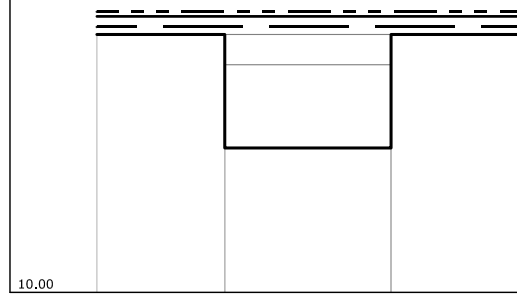

PUNTI	1	2	4	6
QUOTE [m s.l.m.]	13.41	13.41	11.91	13.41
DISTANZE PROGRESSIVE [m]	0.00	1.69	3.89	5.61
DISTANZE PARZIALI [m]		1.69	2.20	1.72



Canale Bolfano  
 SEZIONE N° 00079PC08

LEGENDA:

TR30 H = 13.37 m. s.l.m. \_\_\_\_\_

TR200 H = 13.47 m. s.l.m. \_\_\_\_\_

TR500 H = 13.50 m. s.l.m. - - - - -

SCALA DISTANZE 1:100  
 SCALA QUOTE 1:100

10.00

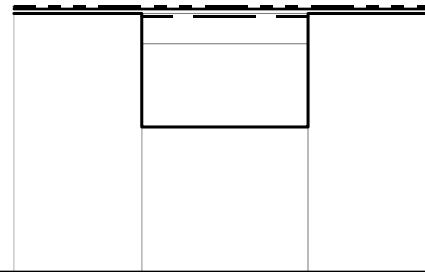



PUNTI	1	2	4	6
QUOTE [m s.l.m.]	13.41	13.41	11.91	13.41
DISTANZE PROGRESSIVE [m]	0.00	1.69	3.89	5.61
DISTANZE PARZIALI [m]		1.69	2.20	1.72

Canale Bolfano  
SEZIONE N° 00079PD08

LEGENDA:

TR30 H =13.35 m. s.l.m. 

TR200 H =13.47 m. s.l.m. 

TR500 H =13.51 m. s.l.m. 

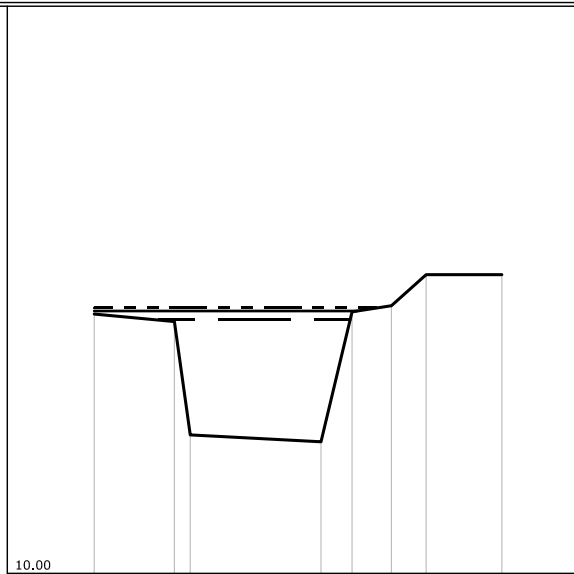

SCALA DISTANZE 1:100  
SCALA QUOTE 1:100

PUNTI	1	2	3	4	5	6	7	8
QUOTE [m s.l.m.]	13.43	13.33	11.83	11.74	13.46	13.54	13.95	13.95
DISTANZE PROGRESSIVE [m]	0.00	1.06	1.27	3.00	3.41	3.93	4.39	5.39
DISTANZE PARZIALI [m]		1.06		1.73		0.52		1.00

Canale Bolfano  
SEZIONE N° 00077PA08

LEGENDA:

TR30 H = 13.30 m. s.l.m. 

TR200 H = 13.42 m. s.l.m. 

TR500 H = 13.46 m. s.l.m. 

SCALA DISTANZE 1:100  
SCALA QUOTE 1:100

10.00

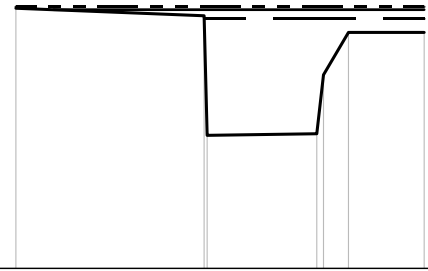

PUNTI	1	2	4	6	7
QUOTE [m s.l.m.]	13.44	13.34	11.78	13.12	13.12
DISTANZE PROGRESSIVE [m]	0.00	2.49	3.98	4.40	5.40
DISTANZE PARZIALI [m]		2.49	1.45	1.00	

Canale Bolfano  
 SEZIONE N° 00077PB08

LEGENDA:

TR30 H = 13.29 m. s.l.m. \_\_\_\_\_

TR200 H = 13.43 m. s.l.m. \_\_\_\_\_

TR500 H = 13.47 m. s.l.m. \_\_\_\_\_

SCALA DISTANZE 1:100  
 SCALA QUOTE 1:100

10.00

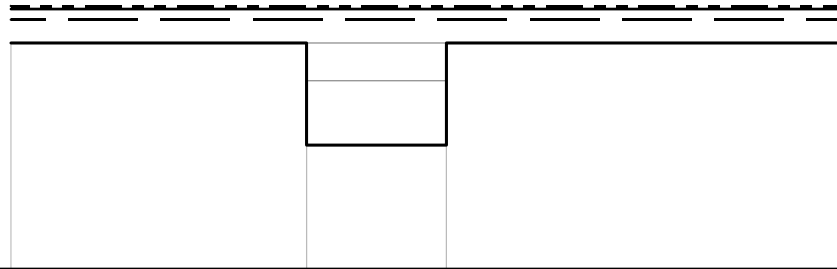



PUNTI	1	2	4	6
QUOTE [m s.l.m.]	12.98	12.98	11.63	12.98
DISTANZE PROGRESSIVE [m]	0.00	3.91	5.76	10.98
DISTANZE PARZIALI [m]		3.91	1.85	5.22

Canale Bolfano  
 SEZIONE N° 00077PC08

LEGENDA:

TR30 H = 13.09 m. s.l.m. 

TR200 H = 13.22 m. s.l.m. 

TR500 H = 13.27 m. s.l.m. 

SCALA DISTANZE 1:100  
 SCALA QUOTE 1:100

10.00

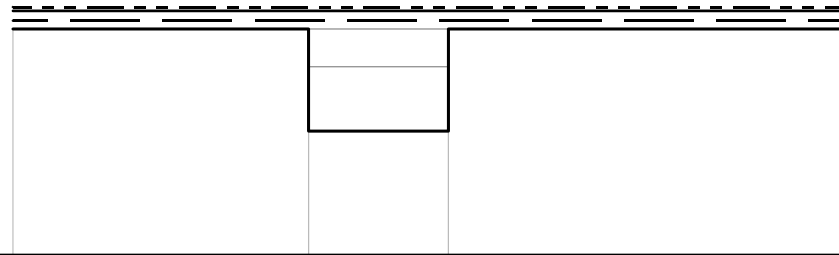

PUNTI	1	2	4	6
QUOTE [m s.l.m.]	12.98	12.98	11.63	12.98
DISTANZE PROGRESSIVE [m]	0.00	3.91	5.76	10.98
DISTANZE PARZIALI [m]		3.91	1.85	5.22

Canale Bolfano  
 SEZIONE N° 00077PD08

LEGENDA:

TR30 H =13.03 m. s.l.m. \_\_\_\_\_

TR200 H =13.17 m. s.l.m. \_\_\_\_\_

TR500 H =13.22 m. s.l.m. \_\_\_\_\_

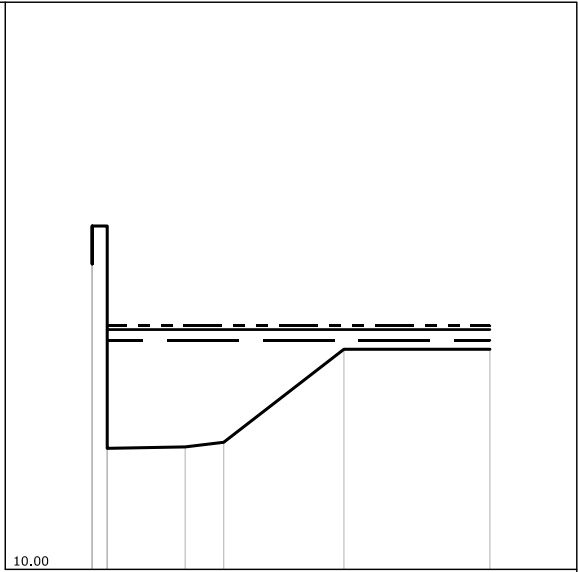



SCALA DISTANZE 1:100  
 SCALA QUOTE 1:100

PUNTI	1	4	6	7	8	9
QUOTE [m s.l.m.]	14.54	14.54	11.62	11.68	12.91	12.91
DISTANZE PROGRESSIVE [m]	0.00	0.20	1.23	1.74	3.33	5.26
DISTANZE PARZIALI [m]		1.03	0.51	1.59	1.93	

Canale Bolfano  
 SEZIONE N° 00075PA08

LEGENDA:

TR30 H = 12.89 m. s.l.m. 

TR200 H = 13.05 m. s.l.m. 

TR500 H = 13.09 m. s.l.m. 

SCALA DISTANZE 1:100  
 SCALA QUOTE 1:100

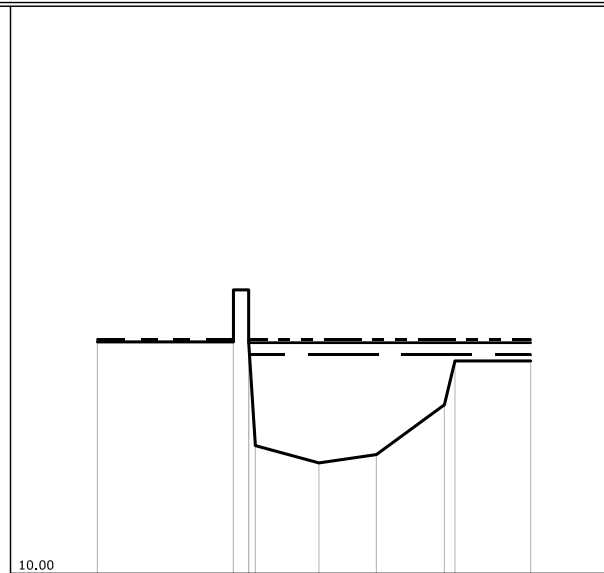



PUNTI	1	2	4	7	8	9	10	11
QUOTE [m s.l.m.]	13.06	13.06	13.75	11.46	11.57	12.23	12.81	12.81
DISTANZE PROGRESSIVE [m]	0.00	1.80	2.00	2.93	3.69	4.99	4.73	5.73
DISTANZE PARZIALI [m]		1.80	0.84	0.76	0.90	1.00		

Canale Bolfano  
 SEZIONE N° 00075PB08

LEGENDA:

TR30 H = 12.90 m. s.l.m. 

TR200 H = 13.07 m. s.l.m. 

TR500 H = 13.11 m. s.l.m. 

SCALA DISTANZE 1:100  
 SCALA QUOTE 1:100

10.00

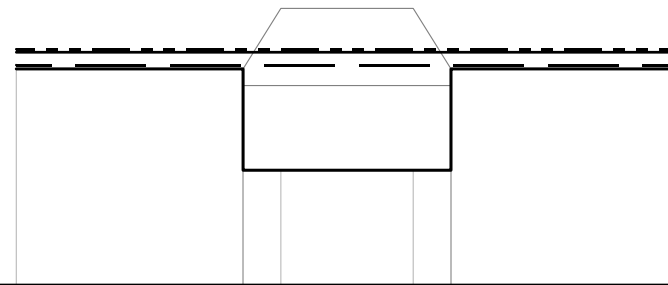



PUNTI	1	2	4	5	6	8
QUOTE [m s.l.m.]	12.85	12.85	11.51	11.51	11.51	12.85
DISTANZE PROGRESSIVE [m]	0.00	3.00	3.50	5.25	5.75	8.75
DISTANZE PARZIALI [m]		3.00	0.50	1.75	0.50	3.00



Canale Bolfano  
 SEZIONE N° 00075PC08

LEGENDA:

TR30 H =12.91 m. s.l.m. 

TR200 H =12.92 m. s.l.m. 

TR500 H =12.94 m. s.l.m. 

SCALA DISTANZE 1:100  
 SCALA QUOTE 1:100

10.00

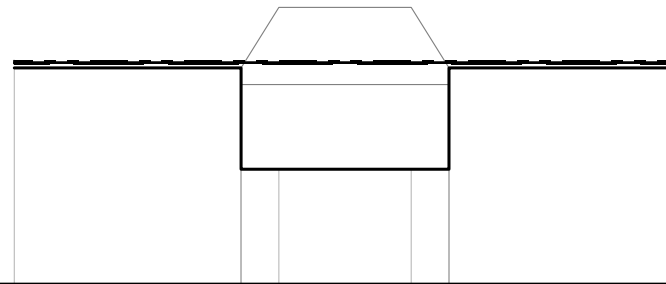



PUNTI	1	2	4	5	6	8
QUOTE [m s.l.m.]	12.85	12.85	11.51	11.51	11.51	12.85
DISTANZE PROGRESSIVE [m]	0.00	3.00	3.50	5.25	5.75	8.75
DISTANZE PARZIALI [m]		3.00	0.50	1.75	0.50	3.00

Canale Bolfano  
SEZIONE N° 00075PD08

LEGENDA:

TR30 H =12.84 m. s.l.m. 

TR200 H =12.91 m. s.l.m. 

TR500 H =12.93 m. s.l.m. 

SCALA DISTANZE 1:100  
SCALA QUOTE 1:100

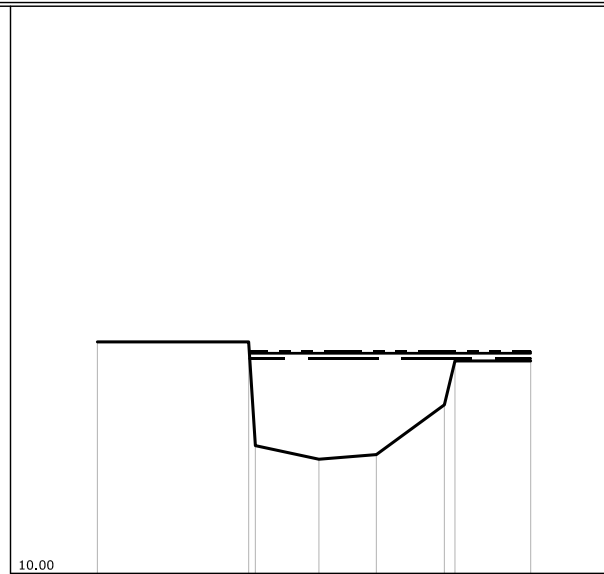

PUNTI	1	2	4	5	6	7	8
QUOTE [m s.l.m.]	13.06	13.06	11.51	11.57	12.23	12.81	12.81
DISTANZE PROGRESSIVE [m]	0.00	2.00	2.93	3.69	4.99	4.73	5.73
DISTANZE PARZIALI [m]		2.00	0.84	0.76	0.90	1.00	

Canale Boffano  
 SEZIONE N° 00064\_\_08

LEGENDA:

TR30 H =11.78 m. s.l.m. ———

TR200 H =11.83 m. s.l.m. ———

TR500 H =11.85 m. s.l.m. - - - - -

SCALA DISTANZE 1:100  
 SCALA QUOTE 1:100

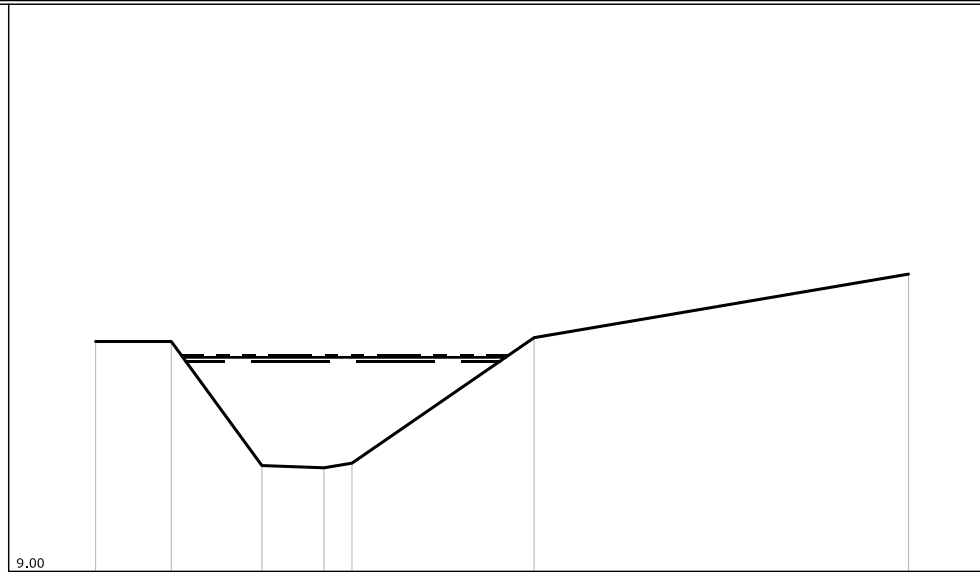

PUNTI	1	2	3	4	5	6	7
QUOTE [m s.l.m.]	12.04	12.04	10.40	10.37	10.43	12.09	12.93
DISTANZE PROGRESSIVE [m]	0.00	1.00	2.20	3.02	3.39	5.80	10.75
DISTANZE PARZIALI [m]		1.00	1.20	0.82		2.41	4.95

Canale Bolfano  
 SEZIONE N° 00059PA08

LEGENDA:

TR30 H = 11.46 m. s.l.m. ———

TR200 H = 11.52 m. s.l.m. ———

TR500 H = 11.54 m. s.l.m. - - - - -

SCALA DISTANZE 1:100  
 SCALA QUOTE 1:100

8.00

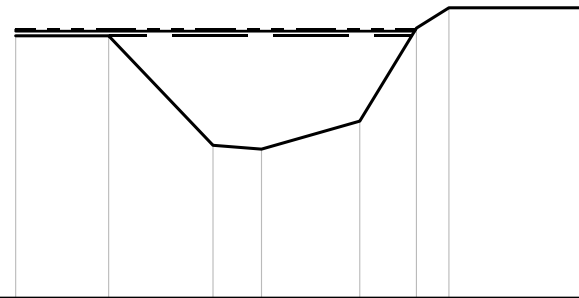

PUNTI	1	2	3	4	5	6	7	8
QUOTE [m s.l.m.]	11.46	11.46	10.01	9.96	10.33	11.56	11.83	11.83
DISTANZE PROGRESSIVE [m]	0.00	1.23	2.61	3.25	4.55	5.30	5.73	7.60
DISTANZE PARZIALI [m]		1.23	1.38	0.64	1.30	0.75		1.87

Canale Bolfano  
 SEZIONE N° 00059PB08

LEGENDA:

TR30 H = 11.45 m. s.l.m. ———

TR200 H = 11.50 m. s.l.m. ———

TR500 H = 11.52 m. s.l.m. - - - - -

SCALA DISTANZE 1:100  
 SCALA QUOTE 1:100

8.00

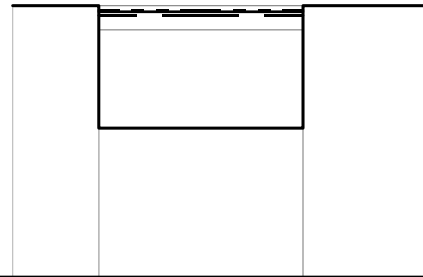

PUNTI	1	2	4	6
QUOTE [m s.l.m.]	11.58	11.58	9.96	11.58
DISTANZE PROGRESSIVE [m]	0.00	1.14	3.84	5.59
DISTANZE PARZIALI [m]		1.14	2.70	1.75

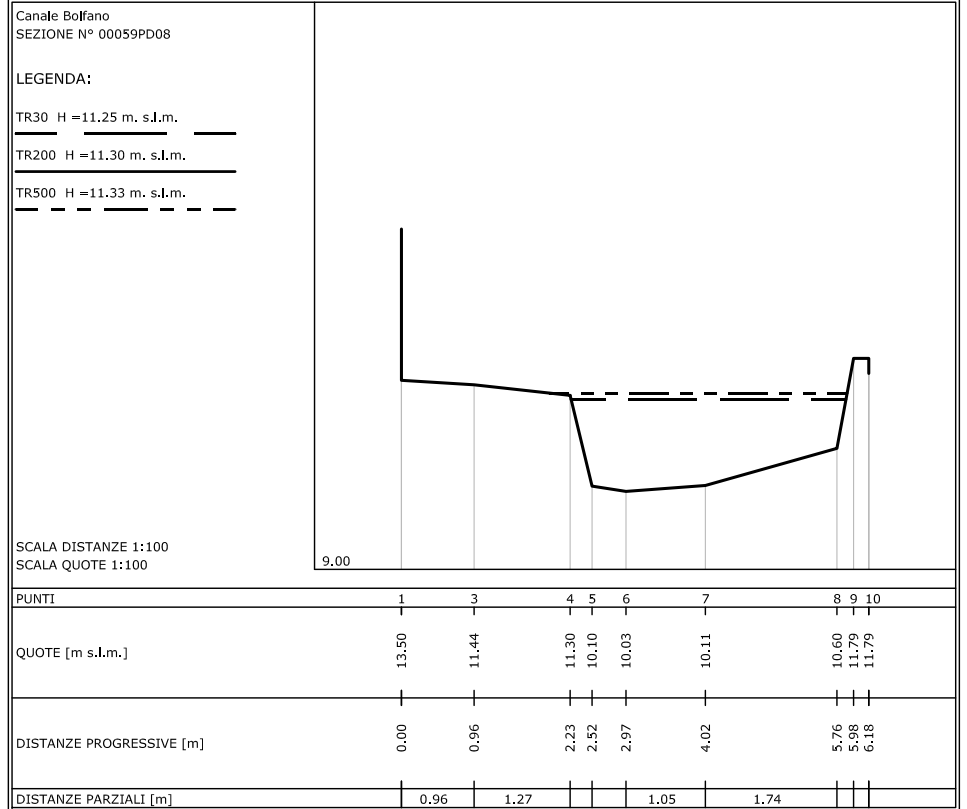

Canale Bolfano  
 SEZIONE N° 00059PC08

LEGENDA:

TR30 H = 11.24 m. s.l.m. \_\_\_\_\_

TR200 H = 11.29 m. s.l.m. \_\_\_\_\_

TR500 H = 11.31 m. s.l.m. - - - - -

SCALA DISTANZE 1:100  
 SCALA QUOTE 1:100

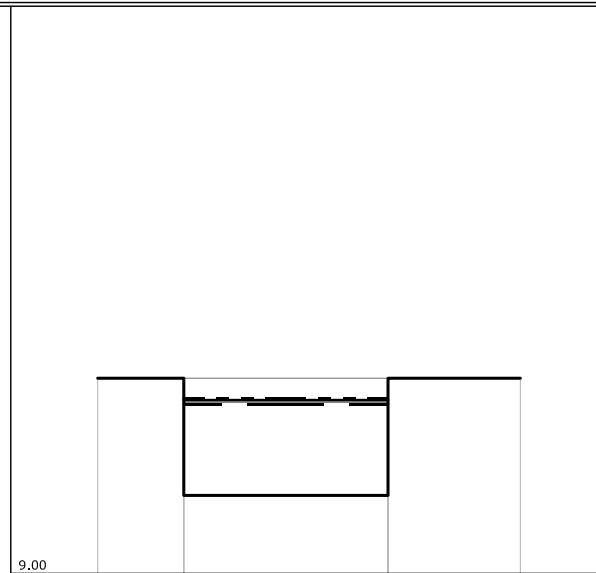



PUNTI	1	2	4	6
QUOTE [m s.l.m.]	11.58	11.58	10.03	11.58
DISTANZE PROGRESSIVE [m]	0.00	1.14	3.84	5.59
DISTANZE PARZIALI [m]		1.14	2.70	1.75

Canale Bolfano  
 SEZIONE N° 00056PA08

LEGENDA:

TR30 H = 11.04 m. s.l.m. 

TR200 H = 11.08 m. s.l.m. 

TR500 H = 11.10 m. s.l.m. 

SCALA DISTANZE 1:100  
 SCALA QUOTE 1:100

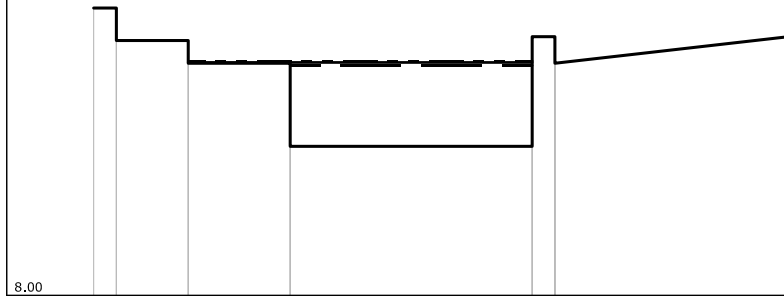



PUNTI	1	2	4	6	8	10	12
QUOTE [m s.l.m.]	11.80	11.80	11.37	11.07	9.97	11.42	11.42
DISTANZE PROGRESSIVE [m]	0.00	0.30	1.25	2.60	5.80	6.10	9.19
DISTANZE PARZIALI [m]		0.95	1.35	3.20		3.09	



Canale Bolfano  
 SEZIONE N° 00056PB08

LEGENDA:

TR30 H = 11.03 m. s.l.m. 

TR200 H = 11.07 m. s.l.m. 

TR500 H = 11.09 m. s.l.m. 

SCALA DISTANZE 1:100  
 SCALA QUOTE 1:100

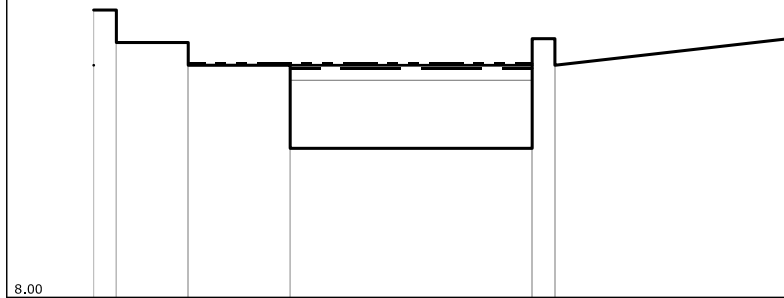

PUNTI	1	2	5	8	10	13	17
QUOTE [m s.l.m.]	11.80	11.80	11.37	11.07	9.97	11.42	11.42
DISTANZE PROGRESSIVE [m]	0.00	0.30	1.25	2.60	5.80	6.10	9.19
DISTANZE PARZIALI [m]		0.95	1.35	3.20		3.09	

Canale Bolfano  
 SEZIONE N° 00056PC08

LEGENDA:

TR30 H = 10.98 m. s.l.m. \_\_\_\_\_

TR200 H = 11.02 m. s.l.m. \_\_\_\_\_

TR500 H = 11.04 m. s.l.m. - - - - -

SCALA DISTANZE 1:100  
 SCALA QUOTE 1:100

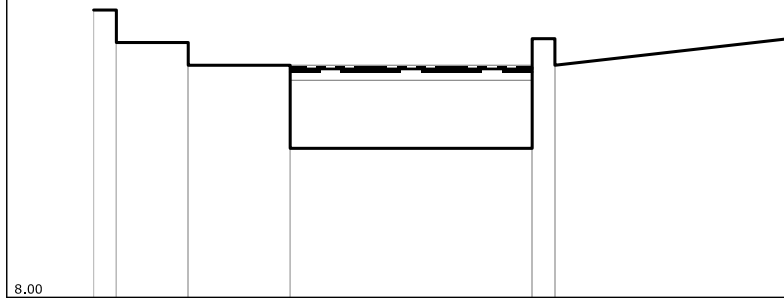

PUNTI	1	2	5	8	10	13	17
QUOTE [m s.l.m.]	11.80	11.80	11.37	11.07	9.97	11.42	11.42
DISTANZE PROGRESSIVE [m]	0.00	0.30	1.25	2.60	5.80	6.10	9.19
DISTANZE PARZIALI [m]			0.95	1.35	3.20		3.09

Canale Bolfano  
 SEZIONE N° 00056PD08

LEGENDA:

TR30 H = 10.97 m. s.l.m. \_\_\_\_\_

TR200 H = 11.01 m. s.l.m. \_\_\_\_\_

TR500 H = 11.03 m. s.l.m. - - - - -

SCALA DISTANZE 1:100  
 SCALA QUOTE 1:100

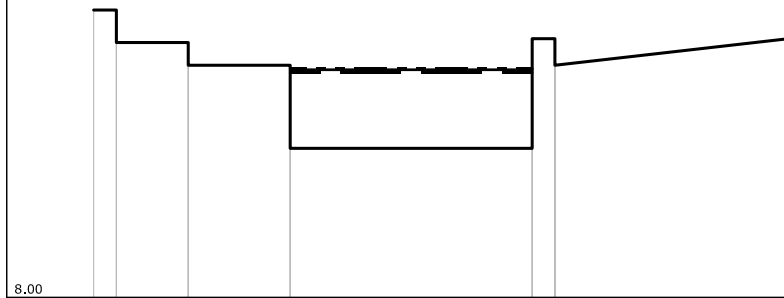

PUNTI	1	2	4	6	8	10	12
QUOTE [m s.l.m.]	11.80	11.80	11.37	11.07	9.97	11.42	11.42
DISTANZE PROGRESSIVE [m]	0.00	0.30	1.25	2.60	5.80	6.10	9.19
DISTANZE PARZIALI [m]		0.95	1.35	3.20		3.09	

Canale Bolfano  
 SEZIONE N° 00055\_\_08

LEGENDA:

TR30 H = 10.93 m. s.l.m. \_\_\_\_\_

TR200 H = 10.97 m. s.l.m. \_\_\_\_\_

TR500 H = 10.98 m. s.l.m. - - - - -

SCALA DISTANZE 1:100  
 SCALA QUOTE 1:100

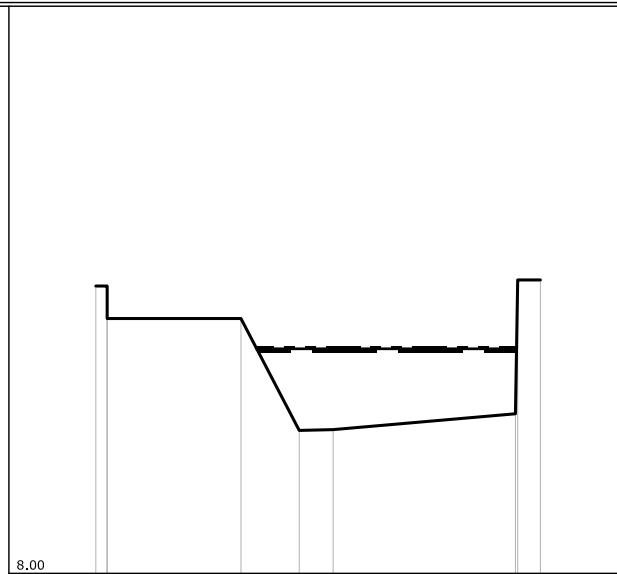

PUNTI	1	2	4	5	6	7	9
QUOTE [m s.l.m.]	11.80	11.80	11.37	9.89	9.90	10.11	11.88
DISTANZE PROGRESSIVE [m]	0.00	0.15	1.92	2.69	3.14	5.55	5.88
DISTANZE PARZIALI [m]			1.77	0.77		2.41	

Canale Bolfano  
 SEZIONE N° 00054PA08

LEGENDA:

TR30 H =10.82 m. s.l.m. ———

TR200 H =10.86 m. s.l.m. ———

TR500 H =10.87 m. s.l.m. - - - - -

SCALA DISTANZE 1:100  
 SCALA QUOTE 1:100

8.00

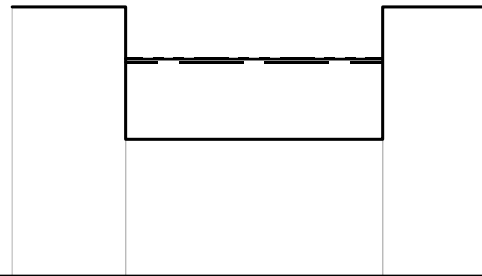



PUNTI	1	2	4	6
QUOTE [m s.l.m.]	11.55	11.55	9.80	11.55
DISTANZE PROGRESSIVE [m]	0.00	1.50	4.90	6.32
DISTANZE PARZIALI [m]		1.50	3.40	1.42

Canale Bolfano  
 SEZIONE N° 00054PB08

LEGENDA:

TR30 H =10.81 m. s.l.m. 

TR200 H =10.85 m. s.l.m. 

TR500 H =10.86 m. s.l.m. 

SCALA DISTANZE 1:100  
 SCALA QUOTE 1:100

8.00

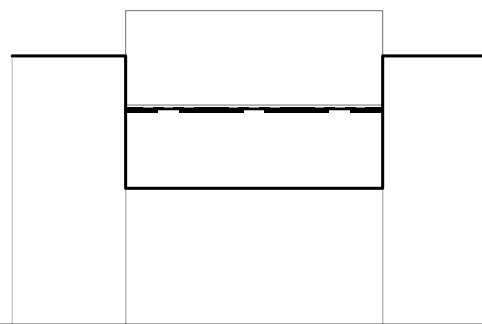

PUNTI	1	2	5	7
QUOTE [m s.l.m.]	11.55	11.55	9.80	11.55
DISTANZE PROGRESSIVE [m]	0.00	1.50	4.90	6.32
DISTANZE PARZIALI [m]		1.50	3.40	1.42

Canale Bolfano  
 SEZIONE N° 00054PC08

LEGENDA:

TR30 H =10.64 m. s.l.m. ———

TR200 H =10.68 m. s.l.m. ———

TR500 H =10.69 m. s.l.m. - - - - -

SCALA DISTANZE 1:100  
 SCALA QUOTE 1:100

8.00

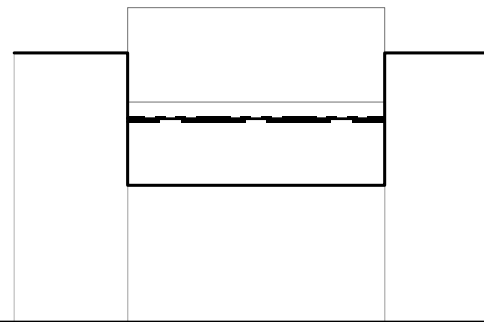

PUNTI	1	2	4	6
QUOTE [m s.l.m.]	11.55	11.55	9.80	11.55
DISTANZE PROGRESSIVE [m]	0.00	1.50	4.90	6.32
DISTANZE PARZIALI [m]		1.50	3.40	1.42

Canale Bolfano  
 SEZIONE N° 00054PD08

LEGENDA:

TR30 H =10.62 m. s.l.m. ———

TR200 H =10.66 m. s.l.m. ———

TR500 H =10.68 m. s.l.m. - - - - -

SCALA DISTANZE 1:100  
 SCALA QUOTE 1:100

8.00

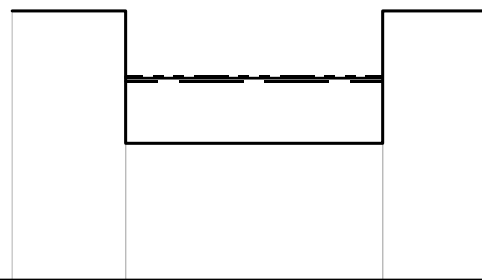



PUNTI	1	2	4	6
QUOTE [m s.l.m.]	11.55	11.55	9.80	11.55
DISTANZE PROGRESSIVE [m]	0.00	1.50	4.90	6.32
DISTANZE PARZIALI [m]		1.50	3.40	1.42



Canale Boffano  
 SEZIONE N° 00053BB08

**LEGENDA:**

TR30 H =10.51 m. s.l.m. 

TR200 H =10.55 m. s.l.m. 

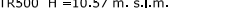
TR500 H =10.57 m. s.l.m. 

SCALA DISTANZE 1:100  
 SCALA QUOTE 1:100

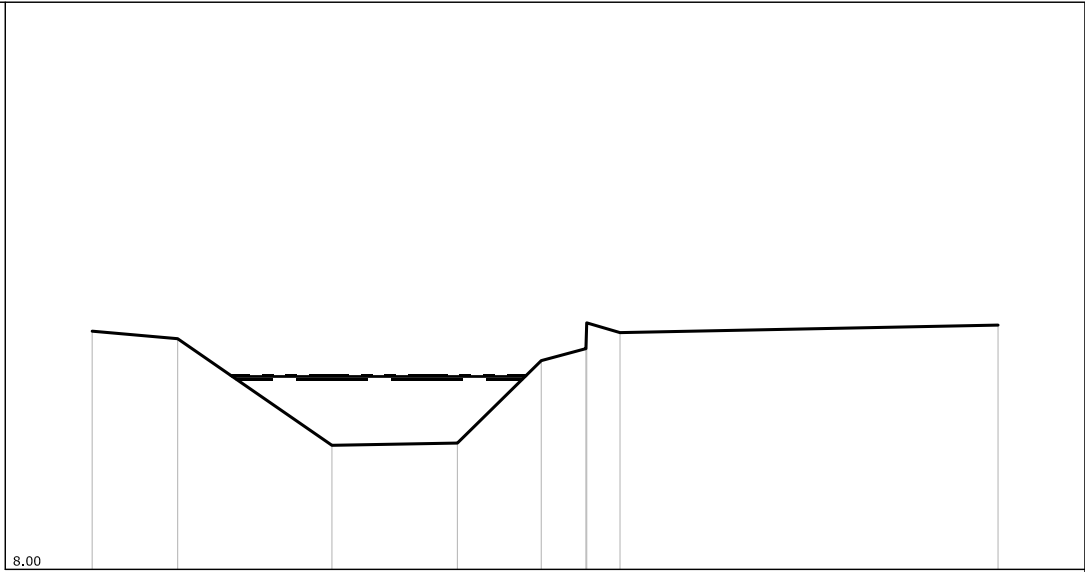

PUNTI	1	2	3	4	5	6	8	9
QUOTE [m s.l.m.]	11.15	11.05	9.64	9.67	10.76	10.92	11.13	11.23
DISTANZE PROGRESSIVE [m]	0.00	1.13	3.17	4.83	5.94	6.53	6.98	11.98
DISTANZE PARZIALI [m]		1.13	2.04	1.66	1.11	0.59		5.00

Canale Boffano  
 SEZIONE N° 00053BC08

LEGENDA:  
 TR30 H =10.50 m. s.l.m. \_\_\_\_\_  
 TR200 H =10.54 m. s.l.m. \_\_\_\_\_  
 TR500 H =10.56 m. s.l.m. - - - - -

SCALA DISTANZE 1:100  
 SCALA QUOTE 1:100

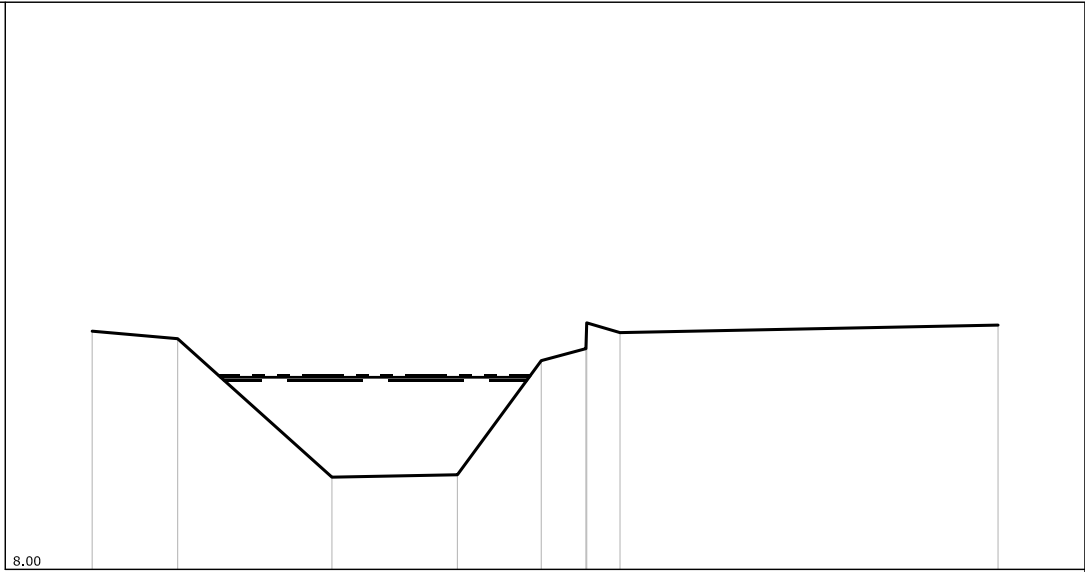

PUNTI	1	2	3	4	5	6	8	9
QUOTE [m s.l.m.]	11.15	11.05	9.22	9.25	10.76	10.92	11.13	11.23
DISTANZE PROGRESSIVE [m]	0.00	1.13	3.17	4.83	5.94	6.53	6.98	11.98
DISTANZE PARZIALI [m]		1.13	2.04	1.66	1.11	0.59		5.00

Canale Boffano  
 SEZIONE N° 00052\_\_08

**LEGENDA:**

TR30 H =10.42 m. s.l.m. \_\_\_\_\_

TR200 H =10.46 m. s.l.m. \_\_\_\_\_

TR500 H =10.47 m. s.l.m. - - - - -

SCALA DISTANZE 1:100  
 SCALA QUOTE 1:100

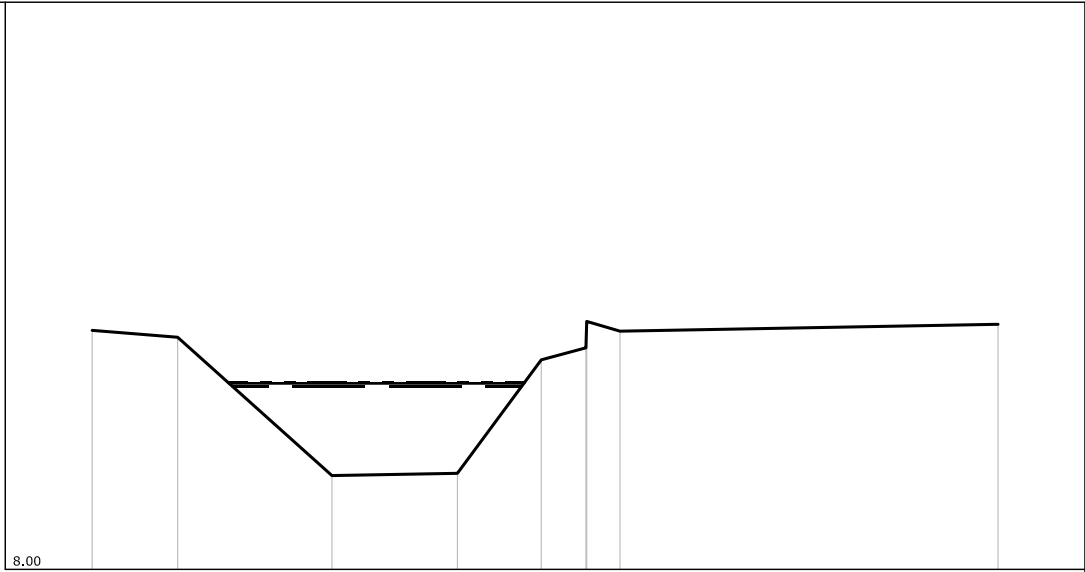

PUNTI	1	2	3	4	5	6	8	9
QUOTE [m s.l.m.]	11.16	11.07	9.24	9.27	10.77	10.93	11.15	11.24
DISTANZE PROGRESSIVE [m]	0.00	1.13	3.17	4.83	5.94	6.53	6.98	11.98
DISTANZE PARZIALI [m]		1.13	2.04	1.66	1.11	0.59		5.00

Canale Bolfano  
 SEZIONE N° 00044\_\_08

LEGENDA:

- TR30 H =9.76 m. s.l.m.
- TR200 H =9.80 m. s.l.m.
- TR500 H =9.81 m. s.l.m.

SCALA DISTANZE 1:100  
 SCALA QUOTE 1:100

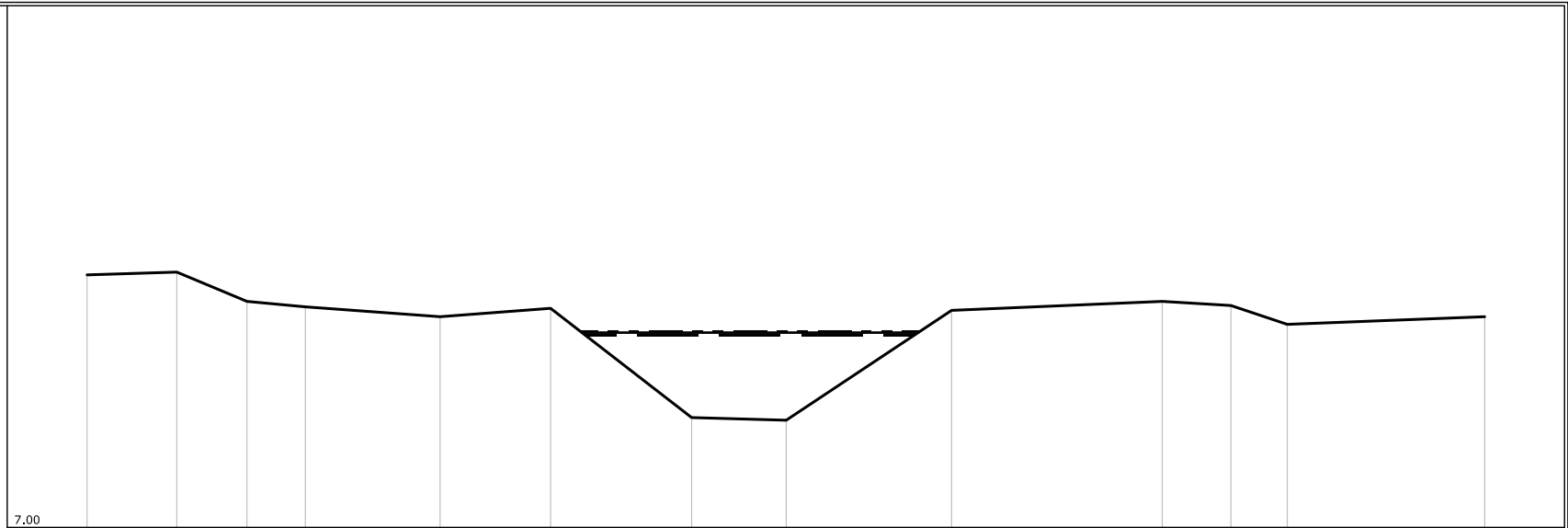

PUNTI	1	2	3	4	5	6	7	8	9	10	11	12	13
QUOTE [m s.l.m.]	10.63	10.67	10.25	10.17	10.03	10.15	8.58	8.54	10.12	10.25	10.19	9.92	10.03
DISTANZE PROGRESSIVE [m]	0.00	1.29	2.30	3.14	5.08	6.67	8.70	10.06	12.44	15.47	16.46	17.27	20.11
DISTANZE PARZIALI [m]		1.29	1.01	0.84	1.94	1.59	2.03	1.36	2.38	3.03	0.99	0.81	2.84

Canale Bolfano  
SEZIONE N° 00037\_\_08

LEGENDA:

TR30 H = 9.33 m. s.l.m. ———

TR200 H = 9.35 m. s.l.m. ———

TR500 H = 9.36 m. s.l.m. - - - - -

SCALA DISTANZE 1:100  
SCALA QUOTE 1:100

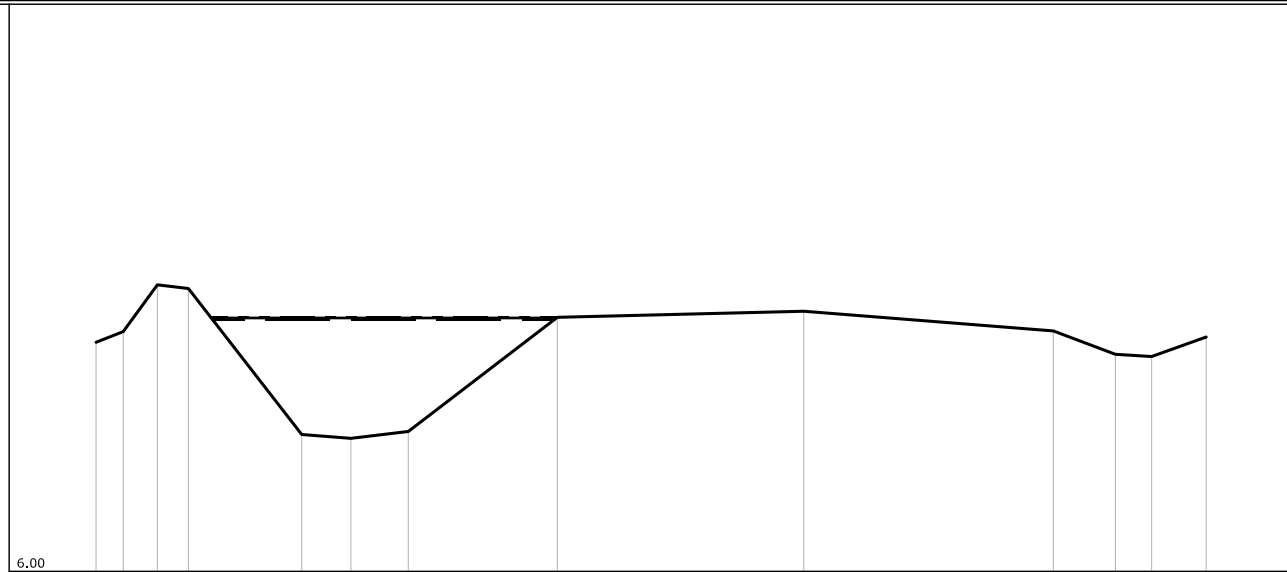

PUNTI	1	2	3	4	5	6	7	8	9	10	11	12	13	
QUOTE [m s.l.m.]	9.03	9.17	9.79	9.74	7.81	7.76	7.85	9.36	9.44	9.18	8.87	8.84	9.10	
DISTANZE PROGRESSIVE [m]	0.00	0.36	0.81	1.22	2.72	3.37	4.13	6.10	9.36	12.66	13.48	13.96	14.68	
DISTANZE PARZIALI [m]					1.50	0.65	0.76	1.97		3.26		3.30	0.82	0.72

Canale Bolfano  
SEZIONE N° 00032\_\_08

LEGENDA:

TR30 H =9.20 m. s.l.m. ———

TR200 H =9.21 m. s.l.m. ———

TR500 H =9.21 m. s.l.m. - - - - -

SCALA DISTANZE 1:100  
SCALA QUOTE 1:100

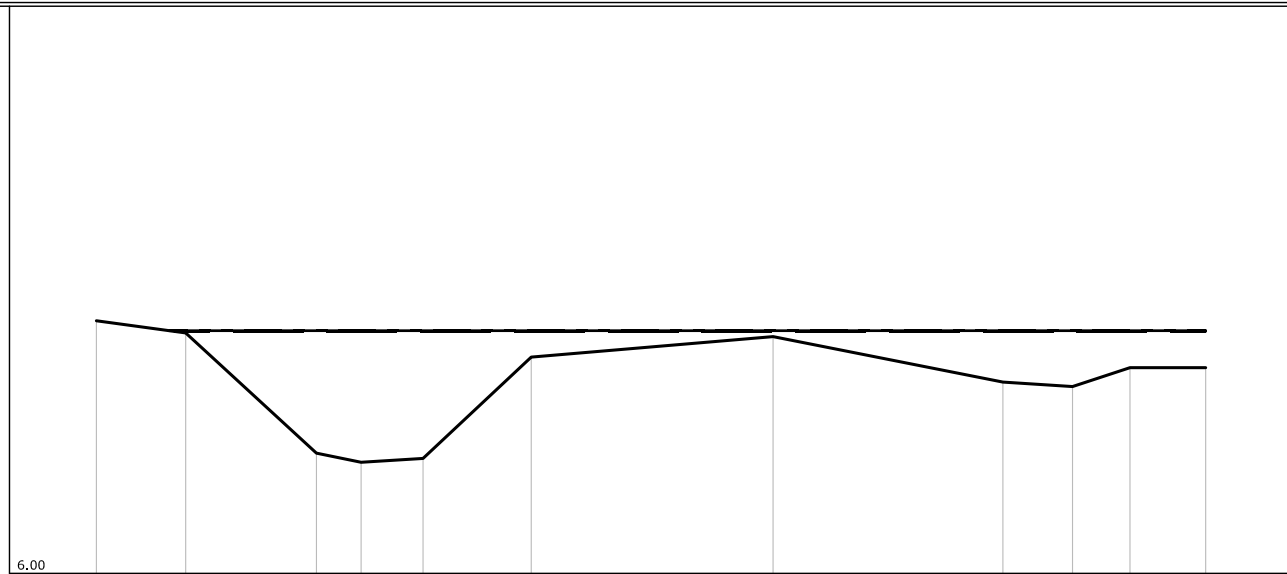

PUNTI	1	2	3	4	5	6	7	8	9	10	11
QUOTE [m s.l.m.]	9.34	9.18	7.59	7.47	7.52	8.86	9.13	8.53	8.47	8.72	8.72
DISTANZE PROGRESSIVE [m]	0.00	1.18	2.91	3.50	4.32	5.75	8.95	11.99	12.91	13.67	14.67
DISTANZE PARZIALI [m]		1.18	1.73	0.59	0.82	1.43	3.20	3.04	0.92	0.76	1.00

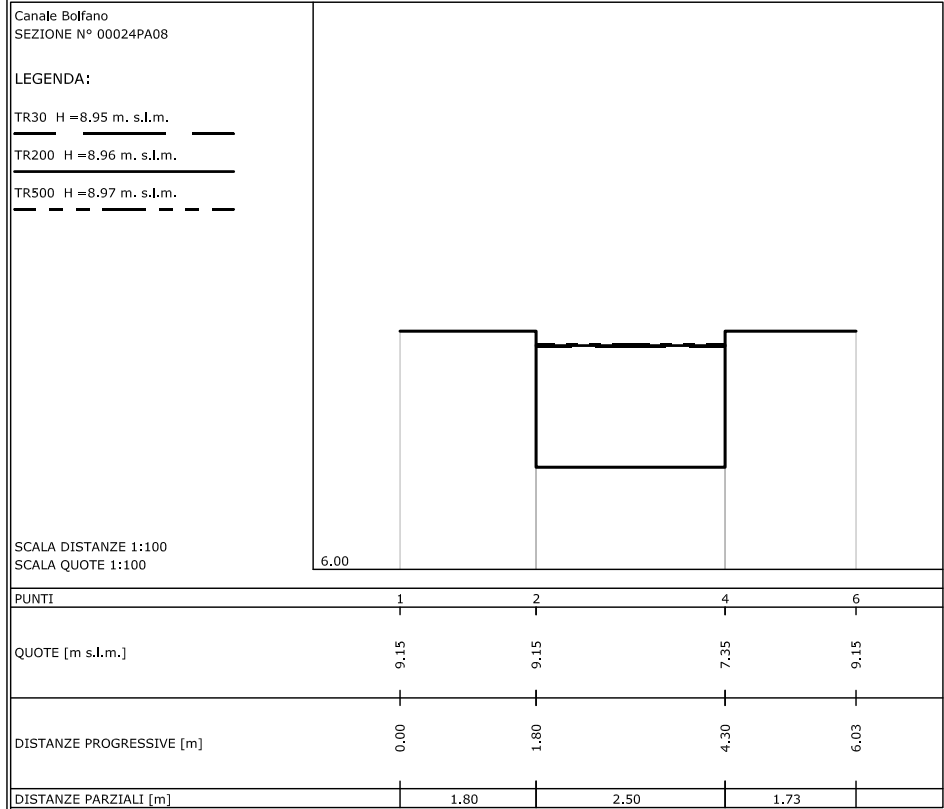





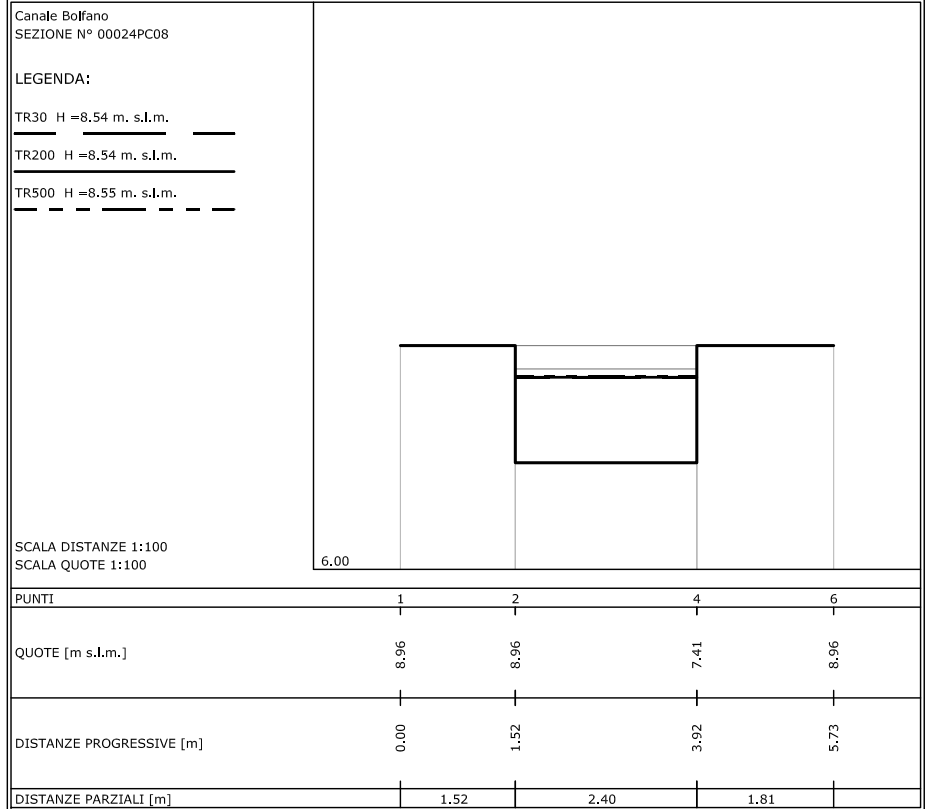



Canale Bolfano  
 SEZIONE N° 00024PD08

LEGENDA:

TR30 H = 8.52 m. s.l.m. 

TR200 H = 8.53 m. s.l.m. 

TR500 H = 8.53 m. s.l.m. 

SCALA DISTANZE 1:100  
 SCALA QUOTE 1:100

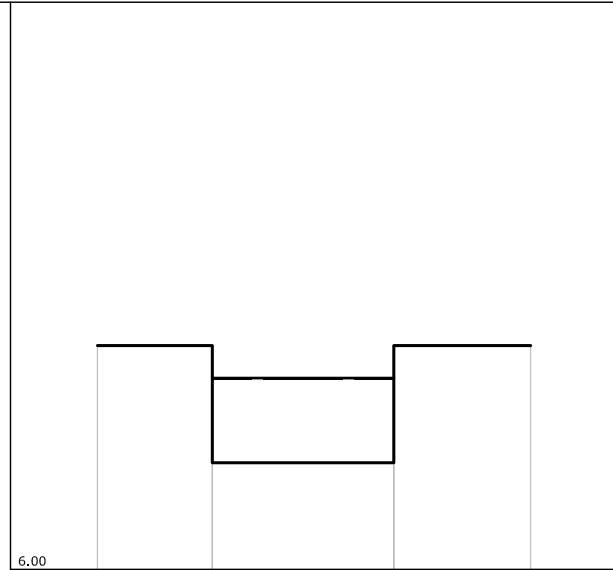



PUNTI	1	2	4	6
QUOTE [m s.l.m.]	8.96	8.96	7.41	8.96
DISTANZE PROGRESSIVE [m]	0.00	1.52	3.92	5.73
DISTANZE PARZIALI [m]		1.52	2.40	1.81

Canale Bolfano  
 SEZIONE N° 00020\_\_08

LEGENDA:

TR30 H =7.82 m. s.l.m. 

TR200 H =7.85 m. s.l.m. 

TR500 H =7.86 m. s.l.m. 

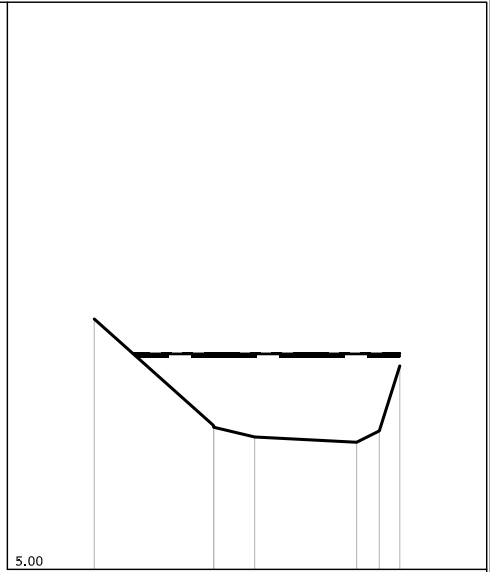

SCALA DISTANZE 1:100  
 SCALA QUOTE 1:100

PUNTI	1	2	4	5	6	7
QUOTE [m s.l.m.]	8.31	6.90	6.75	6.68	6.83	7.69
DISTANZE PROGRESSIVE [m]	0.00	1.58	2.12	3.47	3.77	4.04
DISTANZE PARZIALI [m]		1.58	0.54	1.35		

Canale Bolfano  
SEZIONE N° 00017\_\_08

LEGENDA:

TR30 H =7.61 m. s.l.m. \_\_\_\_\_

TR200 H =7.61 m. s.l.m. \_\_\_\_\_

TR500 H =7.62 m. s.l.m. - - - - -

SCALA DISTANZE 1:100  
SCALA QUOTE 1:100

5.00

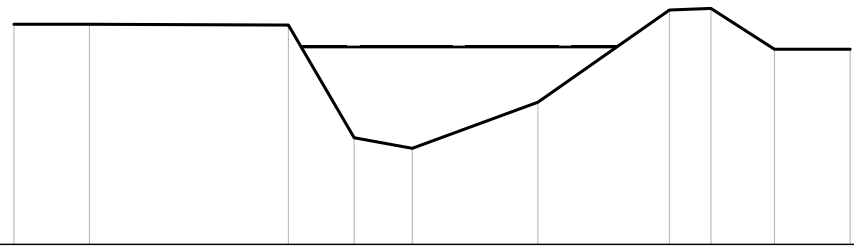

PUNTI	1	2	3	4	5	6	7	8	9	10
QUOTE [m s.l.m.]	7.91	7.91	7.90	6.41	6.27	6.88	8.10	8.12	7.58	7.58
DISTANZE PROGRESSIVE [m]	0.00	1.00	3.63	4.50	5.27	6.93	8.67	9.22	10.06	11.06
DISTANZE PARZIALI [m]		1.00	2.63	0.87	0.77	1.66	1.74	0.55	0.84	1.00

Canale Bolfano  
SEZIONE N° 00011\_\_08

LEGENDA:

TR30 H =7.35 m. s.l.m. ————

TR200 H =7.38 m. s.l.m. ————

TR500 H =7.43 m. s.l.m. - - - - -

SCALA DISTANZE 1:100  
SCALA QUOTE 1:100

5.00

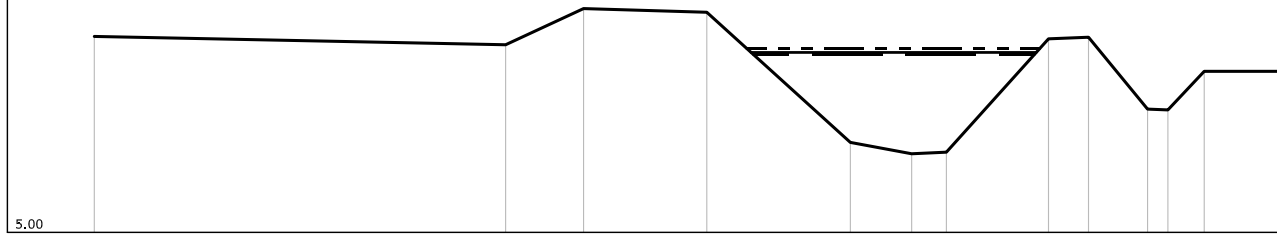

PUNTI	1	2	3	4	5	6	7	8	9	10	11	12	13
QUOTE [m s.l.m.]	7.59	7.48	7.96	7.91	6.19	6.04	6.06	7.56	7.58	6.63	6.62	7.13	7.13
DISTANZE PROGRESSIVE [m]	0.00	5.44	6.47	8.10	10.00	10.81	11.27	12.62	13.15	13.93	14.20	14.68	15.68
DISTANZE PARZIALI [m]		5.44	1.03	1.63	1.90	0.81		1.35	0.53	0.78			1.00

Canale Bolfano  
 SEZIONE N° 00007\_\_08

LEGENDA:

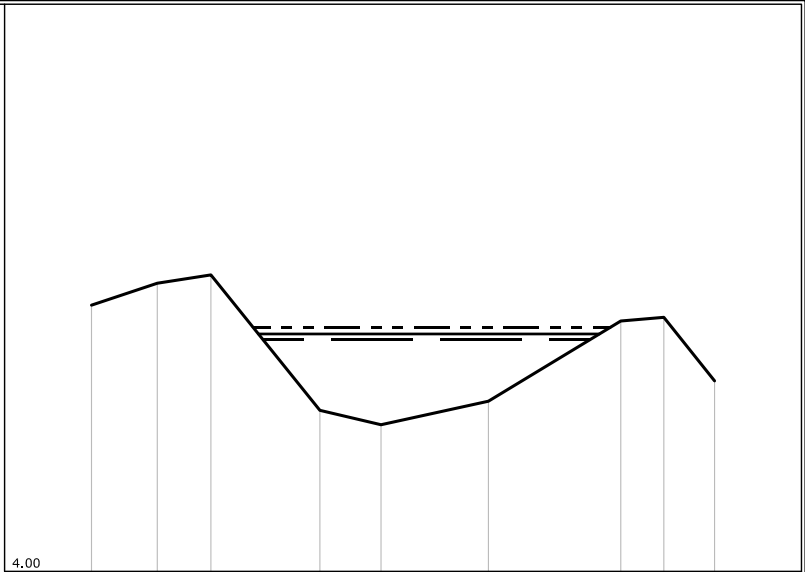

- TR30 H =7.06 m. s.l.m.
- TR200 H =7.14 m. s.l.m.
- TR500 H =7.23 m. s.l.m.

SCALA DISTANZE 1:100  
 SCALA QUOTE 1:100



PUNTI	1	2	3	4	5	6	7	8	9
QUOTE [m s.l.m.]	7.52	7.81	7.92	6.13	5.94	6.25	7.31	7.36	6.52
DISTANZE PROGRESSIVE [m]	0.00	0.87	1.88	3.02	3.83	5.25	7.00	7.57	8.24
DISTANZE PARZIALI [m]		0.87	0.71	1.44	0.81	1.42	1.75	0.57	0.67

Canale Bolfano  
SEZIONE N° 00006PB08

LEGENDA:  
 TR30 H =6.99 m. s.l.m.   
 TR200 H =7.11 m. s.l.m.   
 TR500 H =7.18 m. s.l.m. 

SCALA DISTANZE 1:100  
SCALA QUOTE 1:100

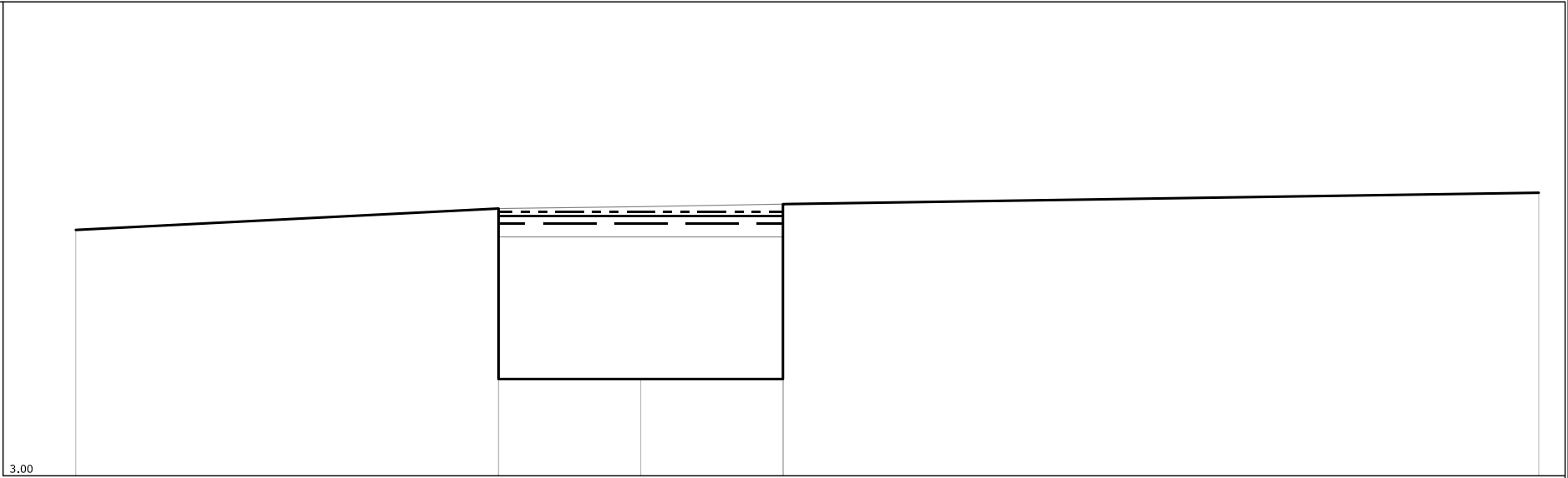

PUNTI	1	2	5	6	10
QUOTE [m s.l.m.]	6.89	7.23	4.53	4.53	7.48
DISTANZE PROGRESSIVE [m]	0.00	6.69	8.94	11.19	23.15
DISTANZE PARZIALI [m]		6.69	2.25	2.25	11.96

Canale Bolfano  
 SEZIONE N° 00006PC08

LEGENDA:

TR30 H = 6.97 m. s.l.m. ———

TR200 H = 7.09 m. s.l.m. ———

TR500 H = 7.15 m. s.l.m. - - - - -

SCALA DISTANZE 1:100  
 SCALA QUOTE 1:100

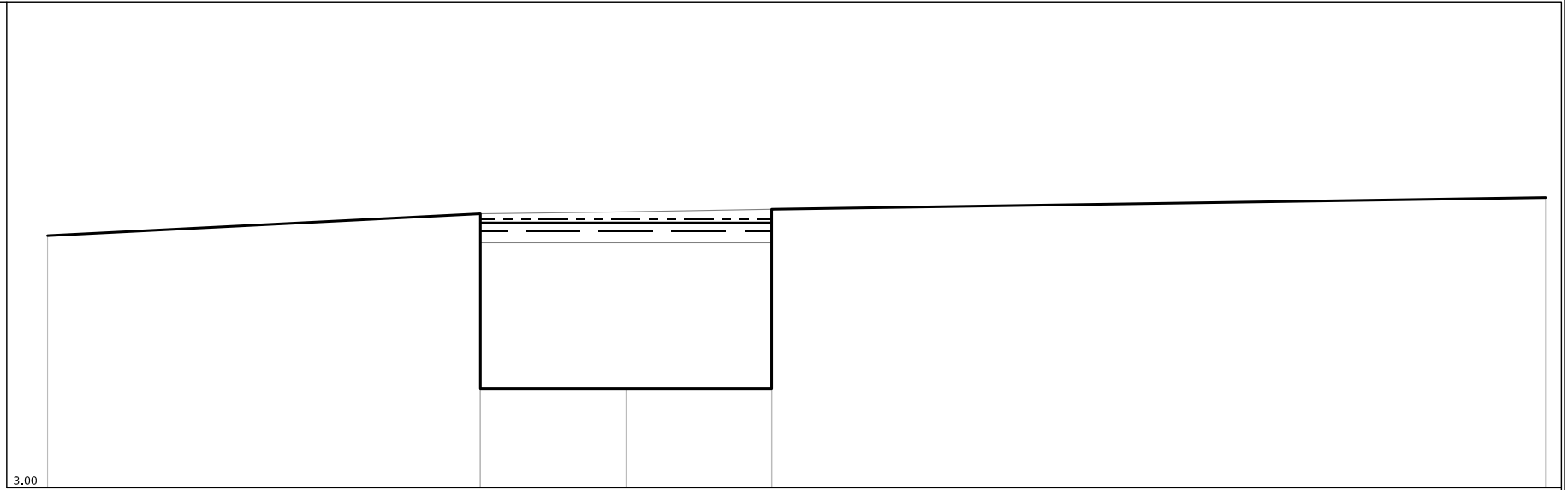

PUNTI	1	2	5	6	10
QUOTE [m s.l.m.]	6.89	7.23	4.53	4.53	7.48
DISTANZE PROGRESSIVE [m]	0.00	6.69	8.94	11.19	23.15
DISTANZE PARZIALI [m]		6.69	2.25	2.25	11.96



Torrente Parmignola

Torrente Parmignola  
SEZIONE N° 00285\_06

LEGENDA:

TR30 H =14.20 m. s.l.m. ————

TR200 H =14.67 m. s.l.m. ————

TR500 H =14.87 m. s.l.m. - - - - -

SCALA DISTANZE 1:200  
SCALA QUOTE 1:200

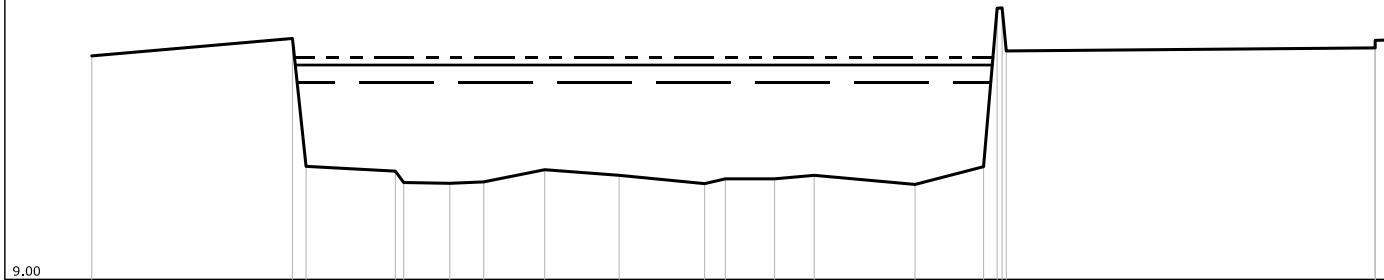

PUNTI	1	2	3	4	6	7	8	9	10	11	12	13	14	15	16	19	21
QUOTE [m s.l.m.]	14.91	15.37	11.99	11.86	11.54	11.58	11.90	11.75	11.53	11.66	11.66	11.75	11.51	11.98	16.17	15.12	15.33
DISTANZE PROGRESSIVE [m]	0.00	5.31	5.67	8.03	9.47	10.37	11.98	13.95	16.21	16.76	18.06	19.11	21.78	23.59	23.95	33.95	34.30
DISTANZE PARZIALI [m]		5.31	2.36	1.22	1.61	1.97	2.26	1.30	1.05	2.67	1.81		9.76				

Torrente Parmignola  
SEZIONE N° 00274\_\_06

LEGENDA:

- TR30 H =13.72 m. s.l.m.
- TR200 H =14.12 m. s.l.m.
- TR500 H =14.28 m. s.l.m.

SCALA DISTANZE 1:200  
SCALA QUOTE 1:200

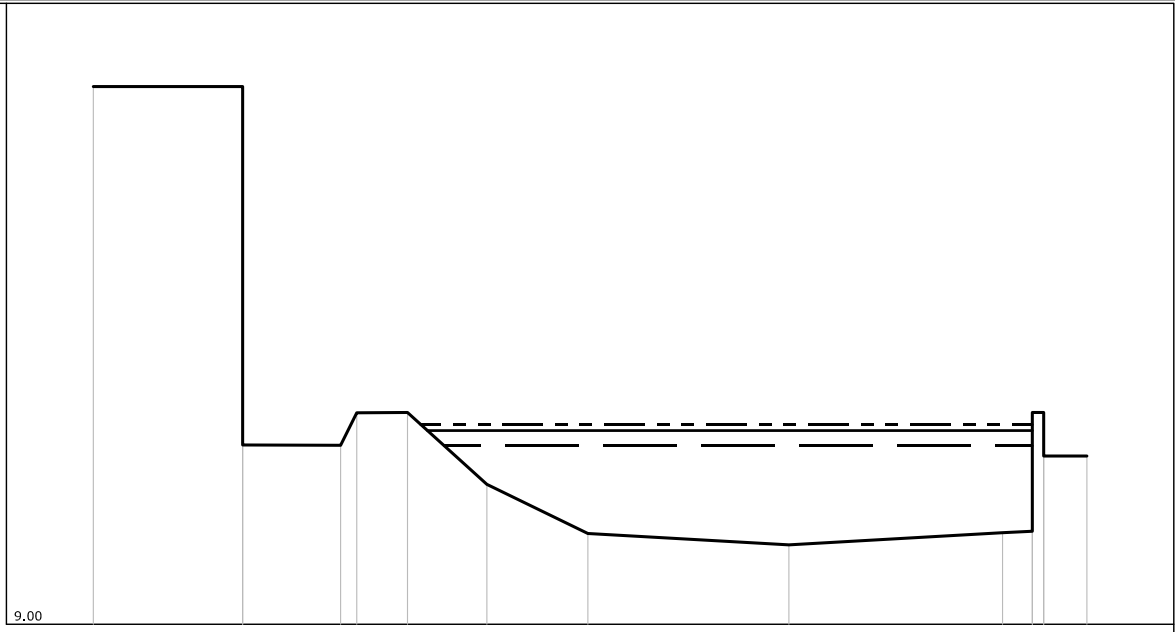

PUNTI	1	2	4	5	6	7	8	9	10	11	13	15
QUOTE [m s.l.m.]	23.22	23.22	13.73	14.59	14.60	12.70	11.40	11.10	11.42	11.46	14.60	13.45
DISTANZE PROGRESSIVE [m]	0.00	3.95	6.54	6.97	8.31	10.41	13.08	18.40	24.05	24.84	25.14	26.28
DISTANZE PARZIALI [m]		3.95	2.59	1.34	2.10	2.67	5.32	5.65		1.14		

Torrente Parmignola  
 SEZIONE N° 00271\_\_06

LEGENDA:

TR30 H =13.60 m. s.l.m. 

TR200 H =13.89 m. s.l.m. 

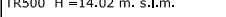
TR500 H =14.02 m. s.l.m. 

SCALA DISTANZE 1:200  
 SCALA QUOTE 1:200

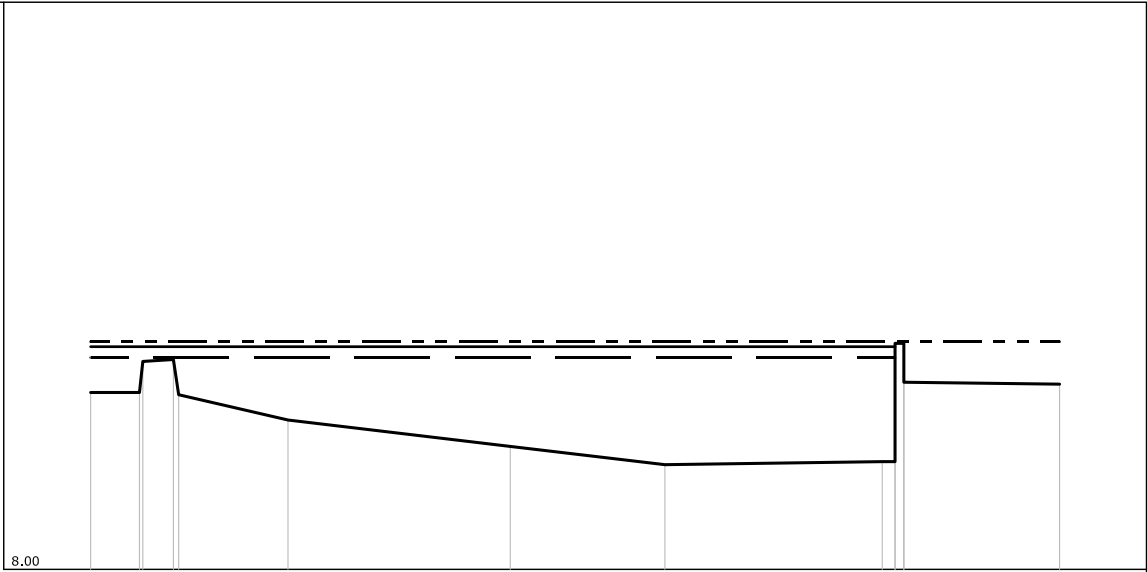



PUNTI	1	2	4	6	7	8	9	10	14				
QUOTE [m s.l.m.]	12.68	12.68	13.55	11.95	11.25	10.77	10.85	10.85	12.90				
DISTANZE PROGRESSIVE [m]	0.00	1.29	2.19	5.22	11.10	15.19	20.94	21.28	25.63				
DISTANZE PARZIALI [m]		1.29		2.89		5.88		4.09		5.75		4.12	

Torrente Parmignola  
SEZIONE N° 00266PB06

LEGENDA:

TR30 H = 13.60 m. s.l.m. 

TR200 H = 13.91 m. s.l.m. 

TR500 H = 14.02 m. s.l.m. 

SCALA DISTANZE 1:200  
SCALA QUOTE 1:200

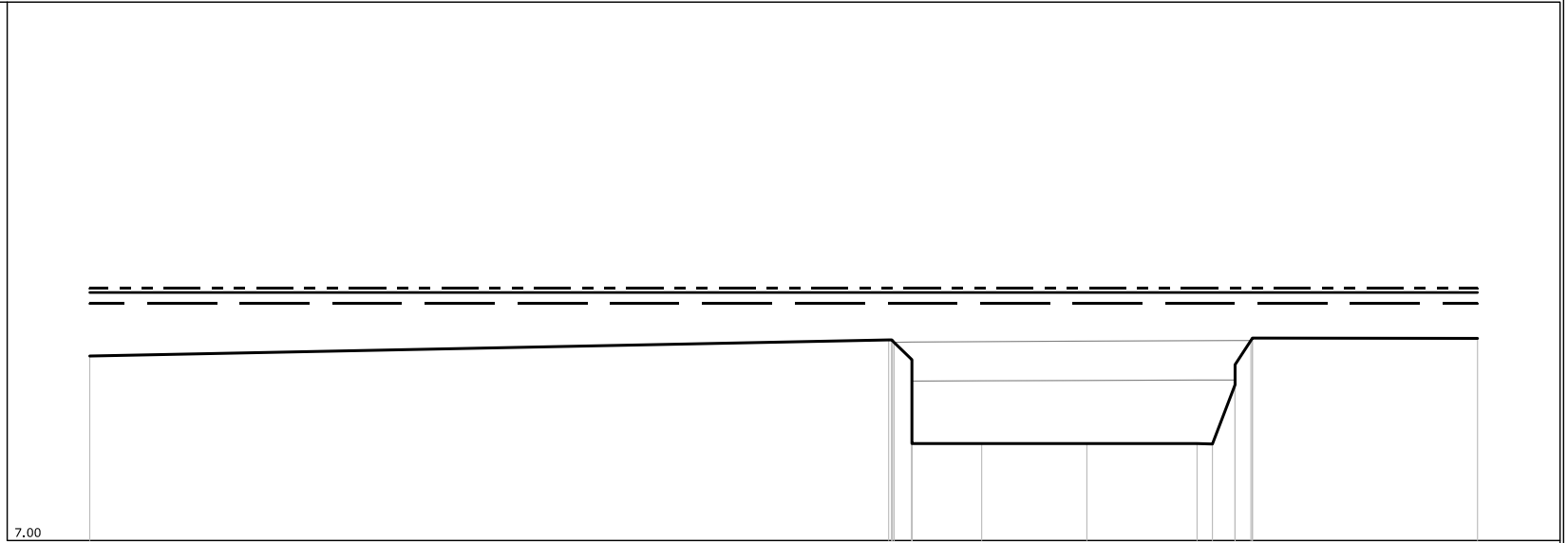



PUNTI	1	2	8	12	13	1415	1619	22	
QUOTE [m s.l.m.]	12.14	12.59	12.04	9.70	9.70	9.70	9.69	11.34	12.63
DISTANZE PROGRESSIVE [m]	0.00	22.25	22.90	24.84	27.77	30.84	31.27	31.90	38.65
DISTANZE PARZIALI [m]		22.25	1.94	2.93	3.07			6.27	

Torrente Parmignola  
SEZIONE N° 00266PC06

LEGENDA:

TR30 H = 13.07 m. s.l.m. 

TR200 H = 13.24 m. s.l.m. 

TR500 H = 13.26 m. s.l.m. 

SCALA DISTANZE 1:200  
SCALA QUOTE 1:200

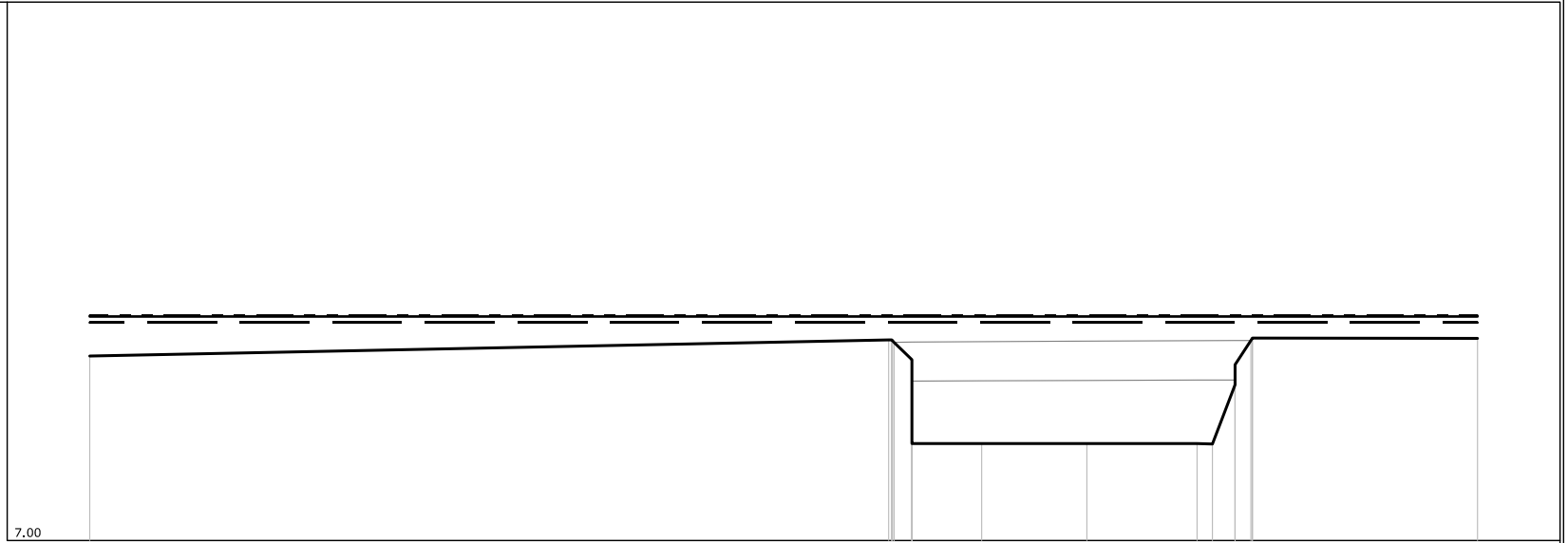

PUNTI	1	2	8	12	13	1415	1619	22	
QUOTE [m s.l.m.]	12.14	12.59	12.04	9.70	9.70	9.70	9.69	11.34	12.63
DISTANZE PROGRESSIVE [m]	0.00	22.25	22.90	24.84	27.77	30.84	31.27	31.90	38.65
DISTANZE PARZIALI [m]		22.25	1.94	2.93	3.07			6.27	

Torrente Parmignola  
 SEZIONE N° 00264PB06

LEGENDA:

- TR30 H = 13.02 m. s.l.m.
- TR200 H = 13.26 m. s.l.m.
- TR500 H = 13.33 m. s.l.m.

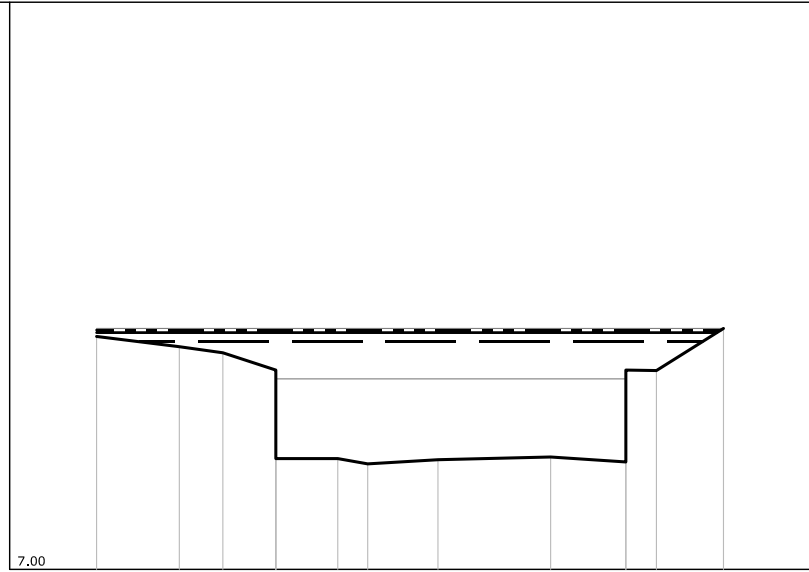



SCALA DISTANZE 1:200  
 SCALA QUOTE 1:200

PUNTI	1	2	3	4	7	8	9	10	11	13	14
QUOTE [m s.l.m.]	13.16	12.89	12.73	12.27	9.93	9.79	9.90	9.97	9.84	12.26	13.37
DISTANZE PROGRESSIVE [m]	0.00	2.19	3.34	4.74	6.38	7.17	9.03	12.01	14.00	14.81	16.58
DISTANZE PARZIALI [m]		2.19	1.15	1.40	1.64		1.86	2.98	1.99		1.77

Torrente Parmignola  
 SEZIONE N° 00264PC06

LEGENDA:

TR30 H = 11.94 m. s.l.m. 

TR200 H = 12.05 m. s.l.m. 

TR500 H = 12.13 m. s.l.m. 

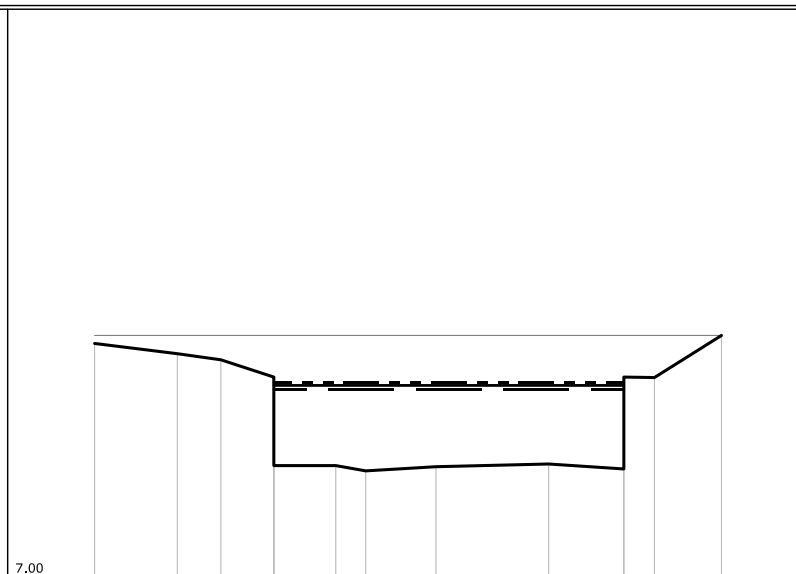

SCALA DISTANZE 1:200  
 SCALA QUOTE 1:200

PUNTI	1	2	3	4	7	8	9	10	11	13	14
QUOTE [m s.l.m.]	13.16	12.89	12.73	12.27	9.93	9.79	9.90	9.97	9.84	12.26	13.37
DISTANZE PROGRESSIVE [m]	0.00	2.19	3.34	4.74	6.38	7.17	9.03	12.01	14.00	14.81	16.58
DISTANZE PARZIALI [m]		2.19	1.15	1.40	1.64		1.86	2.98	1.99		1.77



Torrente Parmignola  
SEZIONE N° 00260\_\_08

LEGENDA:

- TR30 H = 11.63 m. s.l.m.
- TR200 H = 11.75 m. s.l.m.
- TR500 H = 11.82 m. s.l.m.

SCALA DISTANZE 1:200  
SCALA QUOTE 1:200

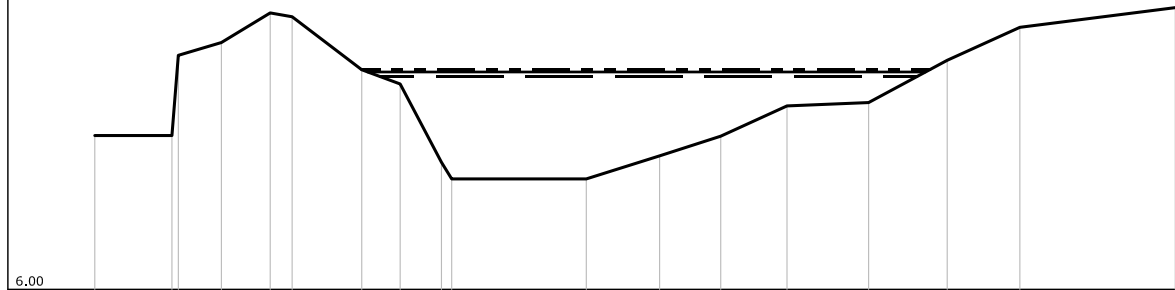

PUNTI	1	2	4	5	6	7	8	9	10	11	12	13	14	15	16	17	18
QUOTE [m s.l.m.]	10.07	10.07	12.53	13.31	13.21	11.81	11.43	9.36	8.92	8.92	9.53	10.05	10.85	10.94	12.06	12.93	13.45
DISTANZE PROGRESSIVE [m]	0.00	2.04	3.35	4.64	5.22	7.06	8.08	9.17	9.44	13.00	14.94	16.56	18.31	20.47	22.55	24.47	28.58
DISTANZE PARZIALI [m]		2.04	1.14	1.29		1.84	1.02	1.09		3.56	1.94	1.62	1.75	2.16	2.08	1.92	4.11

Torrente Parmignola  
SEZIONE N° 00252\_\_08

LEGENDA:

TR30 H = 10.96 m. s.l.m. \_\_\_\_\_

TR200 H = 11.11 m. s.l.m. \_\_\_\_\_

TR500 H = 11.22 m. s.l.m. - - - - -

SCALA DISTANZE 1:200  
SCALA QUOTE 1:200

6.00

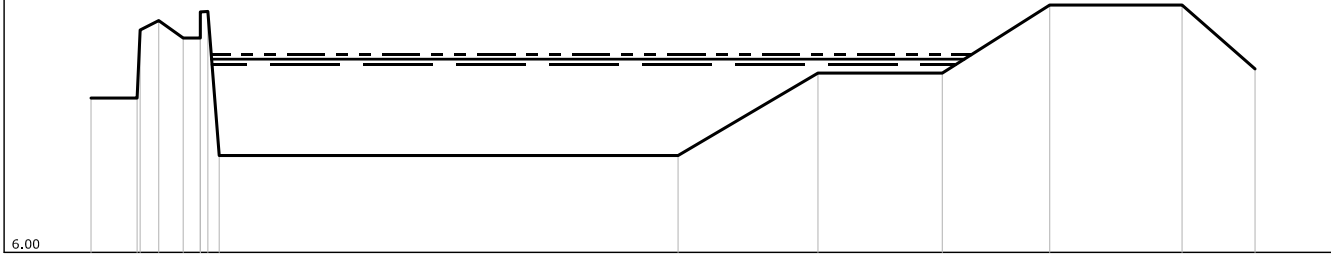

PUNTI	1	2	4	5	6	9	10	11	12	13	14	15
QUOTE [m s.l.m.]	10.08	10.08	12.13	11.67	11.67	8.56	8.56	10.74	10.74	12.54	12.54	10.85
DISTANZE PROGRESSIVE [m]	0.00	1.22	1.79	2.44	2.89	3.39	15.53	19.23	22.52	25.36	28.86	30.79
DISTANZE PARZIALI [m]		1.22					12.14	3.70	3.29	2.84	3.50	1.93

Torrente Parmignola  
 SEZIONE N° 00244\_\_08

LEGENDA:

- TR30 H = 10.72 m. s.l.m.
- TR200 H = 10.91 m. s.l.m.
- TR500 H = 11.04 m. s.l.m.

SCALA DISTANZE 1:200  
 SCALA QUOTE 1:200

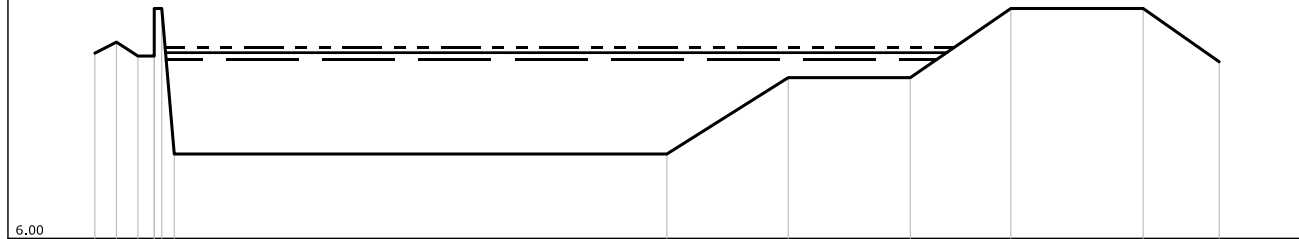

PUNTI	1	2	3	4	7	8	9	10	11	12	13
QUOTE [m s.l.m.]	10.90	11.19	10.82	10.82	8.23	8.23	10.25	10.25	12.08	12.08	10.67
DISTANZE PROGRESSIVE [m]	0.00	0.57	1.14	1.57	2.10	15.13	18.34	21.57	24.23	27.73	29.74
DISTANZE PARZIALI [m]						13.03	3.21	3.23	2.66	3.50	2.01

Torrente Parmignola  
SEZIONE N° 00242\_08

LEGENDA:

TR30 H =10.64 m. s.l.m. \_\_\_\_\_

TR200 H =10.84 m. s.l.m. \_\_\_\_\_

TR500 H =10.97 m. s.l.m. - - - - -

SCALA DISTANZE 1:200  
SCALA QUOTE 1:200

6.00

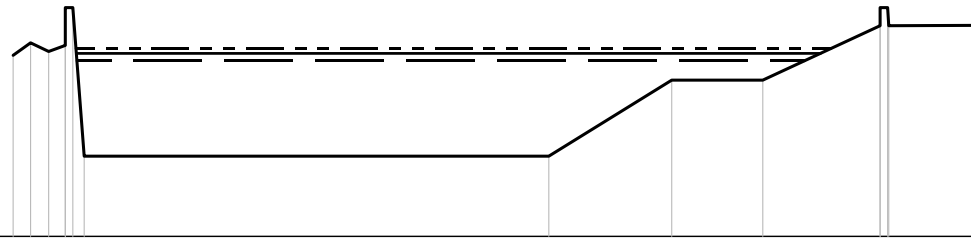



PUNTI	1	2	3	4	7	8	9	10	11	15
QUOTE [m s.l.m.]	10.79	11.12	10.89	11.05	8.12	8.12	10.13	10.13	11.57	11.58
DISTANZE PROGRESSIVE [m]	0.00	0.46	0.94	1.38	1.88	14.17	17.42	19.83	22.93	25.39
DISTANZE PARZIALI [m]						12.29	3.25	2.41	3.10	2.23

Torrente Parmignola  
SEZIONE N° 00239\_\_08

LEGENDA:

TR30 H =10.57 m. s.l.m. 

TR200 H =10.78 m. s.l.m. 

TR500 H =10.93 m. s.l.m. 

SCALA DISTANZE 1:200  
SCALA QUOTE 1:200

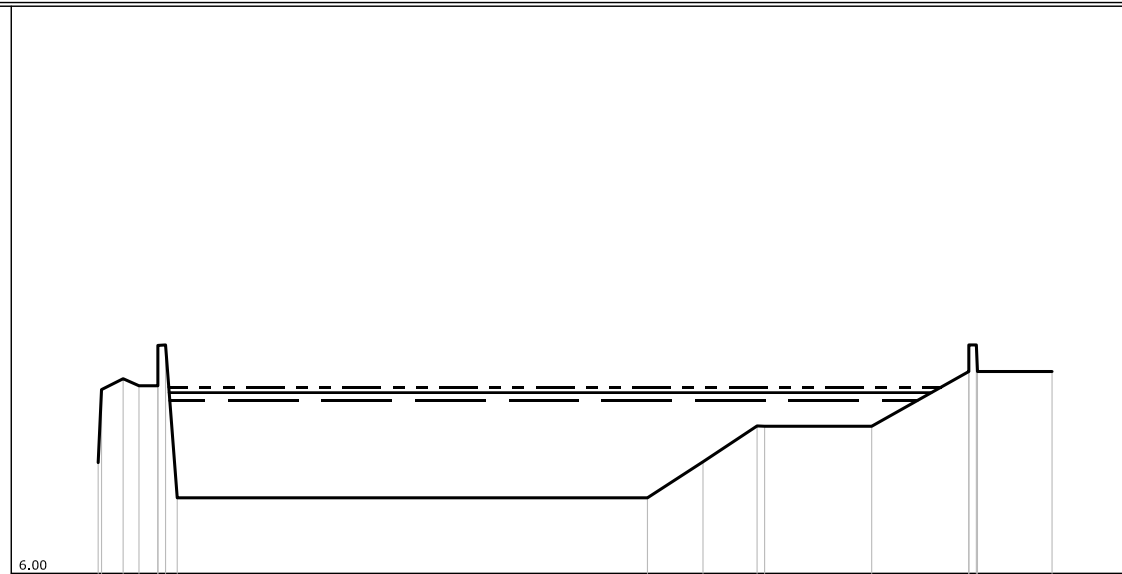

PUNTI	1	3	4	5	8	9	10	11	13	14	18
QUOTE [m s.l.m.]	8.93	11.15	10.96	10.96	8.00	8.00	8.95	9.90	9.89	11.34	11.34
DISTANZE PROGRESSIVE [m]	0.00	0.66	1.08	1.58	2.09	14.53	16.00	17.43	20.46	23.03	25.23
DISTANZE PARZIALI [m]					12.44	1.47	1.43	2.83	2.57	1.97	

Torrente Parmignola  
 SEZIONE N° 00236\_\_08

LEGENDA:

TR30 H = 10.52 m. s.l.m. \_\_\_\_\_

TR200 H = 10.73 m. s.l.m. \_\_\_\_\_

TR500 H = 10.87 m. s.l.m. - - - - -

SCALA DISTANZE 1:200  
 SCALA QUOTE 1:200

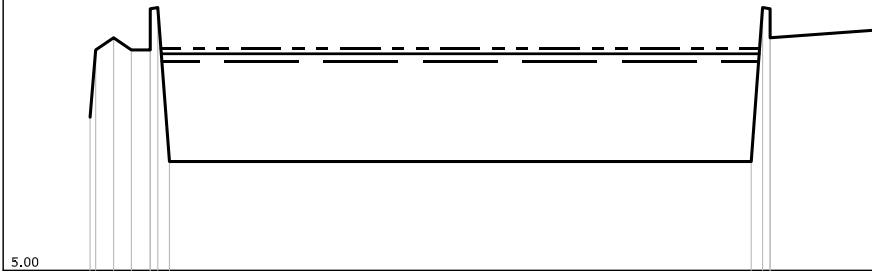



PUNTI	1	3	4	5	8	9	10	13
QUOTE [m s.l.m.]	9.05	11.15	10.83	10.83	7.88	7.88	11.85	11.36
DISTANZE PROGRESSIVE [m]	0.00	0.62	1.09	1.59	2.10	17.49	17.79	20.84
DISTANZE PARZIALI [m]						15.39	2.85	

Torrente ParmIgnola  
SEZIONE N° 00232\_\_08

LEGENDA:

TR30 H =10.42 m. s.l.m. 

TR200 H =10.64 m. s.l.m. 

TR500 H =10.78 m. s.l.m. 

SCALA DISTANZE 1:200  
SCALA QUOTE 1:200

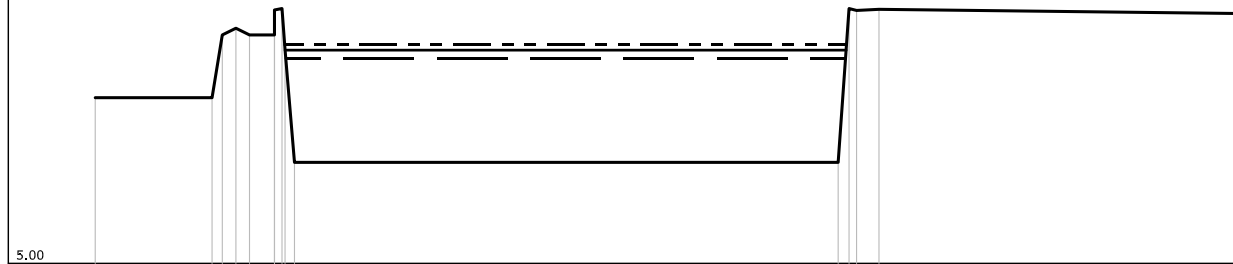

PUNTI	1	2	3	4	5	6	9	10	11	12	14	15
QUOTE [m s.l.m.]	9.38	11.64	11.22	11.04	11.04	10.95	10.95	10.95	10.95	10.95	10.95	11.61
DISTANZE PROGRESSIVE [m]	0.00	3.09	3.72	4.08	4.74	5.27	18.65	19.94	20.73	20.73	20.73	30.20
DISTANZE PARZIALI [m]		3.09					14.38				9.47	

Torrente Parmignola  
SEZIONE N° 00230\_\_08

LEGENDA:

TR30 H = 10.36 m. s.l.m. ———

TR200 H = 10.58 m. s.l.m. ———

TR500 H = 10.73 m. s.l.m. - - - - -

SCALA DISTANZE 1:200  
SCALA QUOTE 1:200

5.00

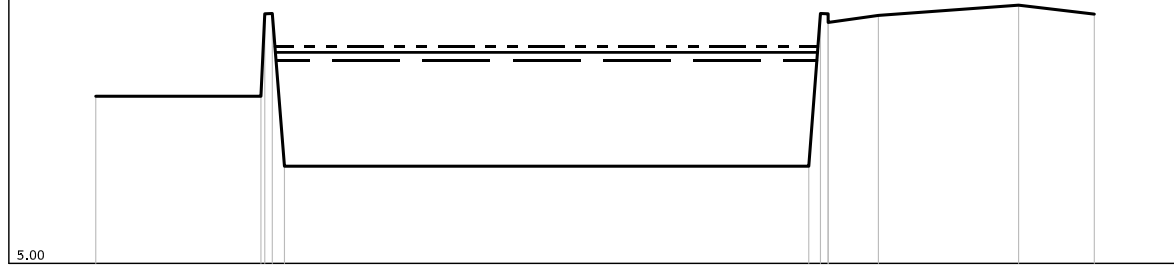

PUNTI	1	2	4	5	6	7	10	11	12
QUOTE [m s.l.m.]	9.42	9.42	11.61	7.57	11.61	11.56	11.83	11.59	
DISTANZE PROGRESSIVE [m]	0.00	4.37	4.67	4.99	18.86	19.17	20.70	24.41	26.41
DISTANZE PARZIALI [m]		4.37			13.87		1.33	3.71	2.00



Torrente Parmignola  
 SEZIONE N° 00229PB08

LEGENDA:  
 TR30 H =10.32 m. s.l.m. ———  
 TR200 H =10.54 m. s.l.m. ———  
 TR500 H =10.69 m. s.l.m. - - - - -

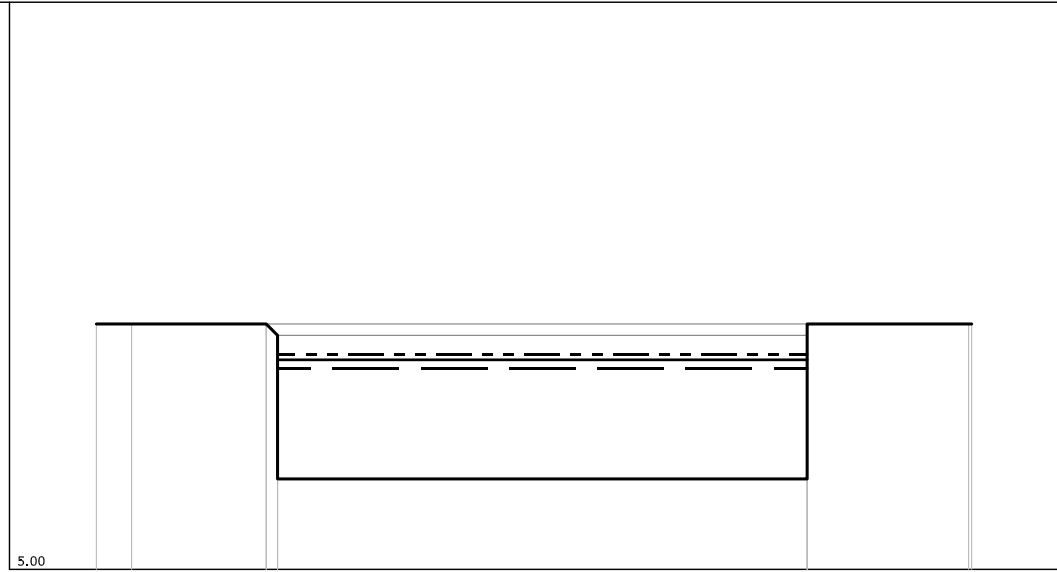

SCALA DISTANZE 1:200  
 SCALA QUOTE 1:200

PUNTI	1	2	3	5	7	10
QUOTE [m s.l.m.]	11.49	11.49	11.49	11.19	7.39	11.49
DISTANZE PROGRESSIVE [m]	0.00	0.93	4.49	4.79	18.80	23.07
DISTANZE PARZIALI [m]			3.56		14.01	4.27

Torrente Parmignola  
 SEZIONE N° 00229PC08

LEGENDA:

TR30 H =9.75 m. s.l.m. ———

TR200 H =9.85 m. s.l.m. ———

TR500 H =9.92 m. s.l.m. - - - - -

SCALA DISTANZE 1:200  
 SCALA QUOTE 1:200

5.00

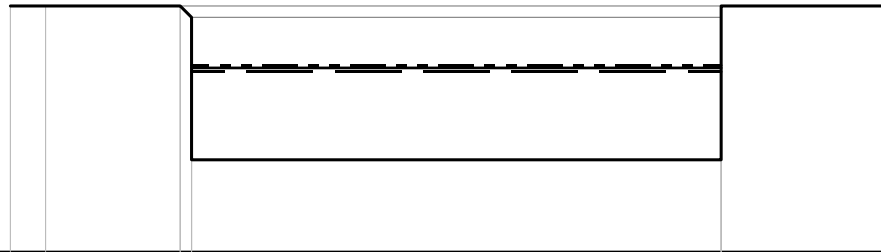

PUNTI	1	2	3	5	7	10
QUOTE [m s.l.m.]	11.49	11.49	11.49	11.19	7.42	11.49
DISTANZE PROGRESSIVE [m]	0.00	0.93	4.49	4.79	18.80	23.07
DISTANZE PARZIALI [m]			3.56		14.01	4.27

Torrente Parmignola  
SEZIONE N° 00228\_\_13

LEGENDA:

TR30 H =9.75 m. s.l.m. ———

TR200 H =9.85 m. s.l.m. ———

TR500 H =9.92 m. s.l.m. - - - - -

SCALA DISTANZE 1:200  
SCALA QUOTE 1:200

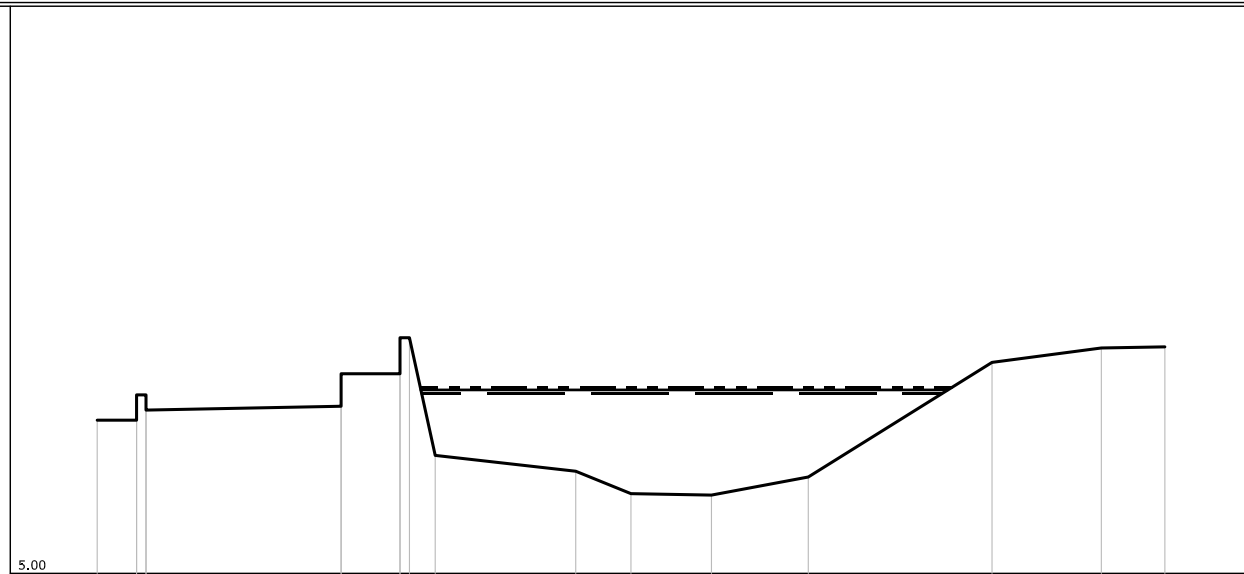

PUNTI	1	24	6	8	10	11	12	13	14	15	16	17	18
QUOTE [m s.l.m.]	9.05	9.95	9.42	10.28	10.28	8.12	7.70	7.11	7.07	7.55	10.58	10.96	10.99
DISTANZE PROGRESSIVE [m]	0.00	1.04	6.45	8.01	8.26	8.94	12.66	14.12	16.25	18.81	23.67	26.56	28.24
DISTANZE PARZIALI [m]	1.04		5.16	1.56			3.72	1.46	2.13	2.56	4.86	2.89	1.68

Torrente Parmignola  
SEZIONE N° 00224\_\_13

LEGENDA:

TR30 H =9.50 m. s.l.m. ———

TR200 H =9.60 m. s.l.m. ———

TR500 H =9.67 m. s.l.m. - - - - -

SCALA DISTANZE 1:200  
SCALA QUOTE 1:200

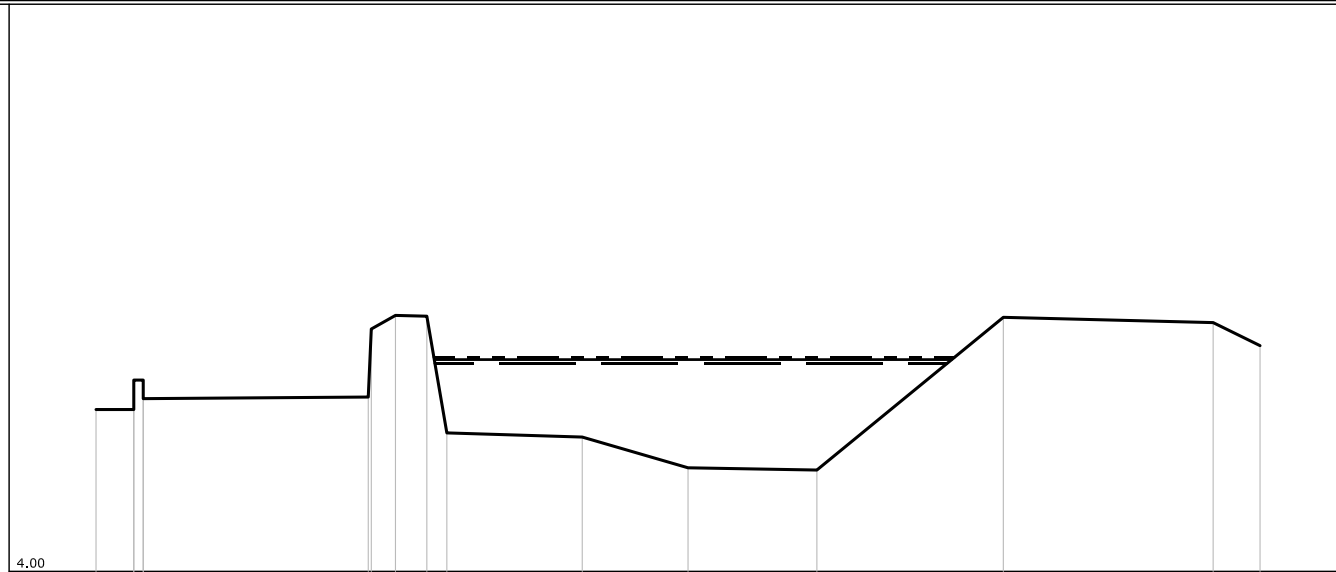

PUNTI	1	24	6	8	9	10	11	12	13	14	15	16
QUOTE [m s.l.m.]	8.28	8.28	8.61	10.77	10.75	7.66	7.55	6.74	6.68	10.72	10.58	9.97
DISTANZE PROGRESSIVE [m]	0.00	1.00	7.20	7.92	8.75	9.28	12.86	15.66	19.07	24.00	29.55	30.79
DISTANZE PARZIALI [m]	1.00		5.95				3.58	2.80	3.41	4.93	5.55	1.24

Torrente Parmignola  
SEZIONE N° 00221\_\_13

LEGENDA:

- TR30 H = 9.35 m. s.l.m.
- TR200 H = 9.45 m. s.l.m.
- TR500 H = 9.52 m. s.l.m.

SCALA DISTANZE 1:200  
SCALA QUOTE 1:200

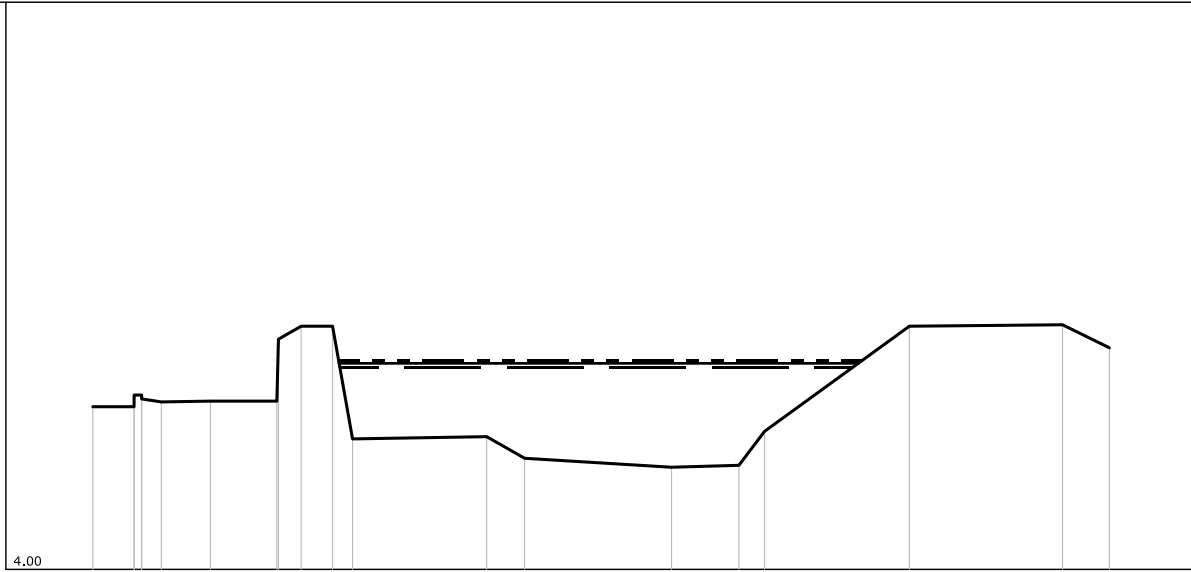

PUNTI	1	2	6	7	8	10	11	12	13	14	15	16	17	18	19	20
QUOTE [m s.l.m.]	8.30	8.30	8.43	8.45	8.45	10.43	10.43	7.45	7.51	6.94	6.70	6.75	7.65	10.43	10.47	9.86
DISTANZE PROGRESSIVE [m]	0.00	1.09	1.81	3.11	4.87	5.51	6.34	6.87	10.42	11.42	15.31	17.09	17.77	21.60	25.65	26.89
DISTANZE PARZIALI [m]		1.09	1.30	1.76					3.55	1.00	3.89	1.78		3.83	4.05	1.24

Torrente Parmignola  
 SEZIONE N° 00218\_\_13

LEGENDA:

TR30 H =9.19 m. s.l.m. ———

TR200 H =9.29 m. s.l.m. ———

TR500 H =9.36 m. s.l.m. - - - - -

SCALA DISTANZE 1:200  
 SCALA QUOTE 1:200

4.00

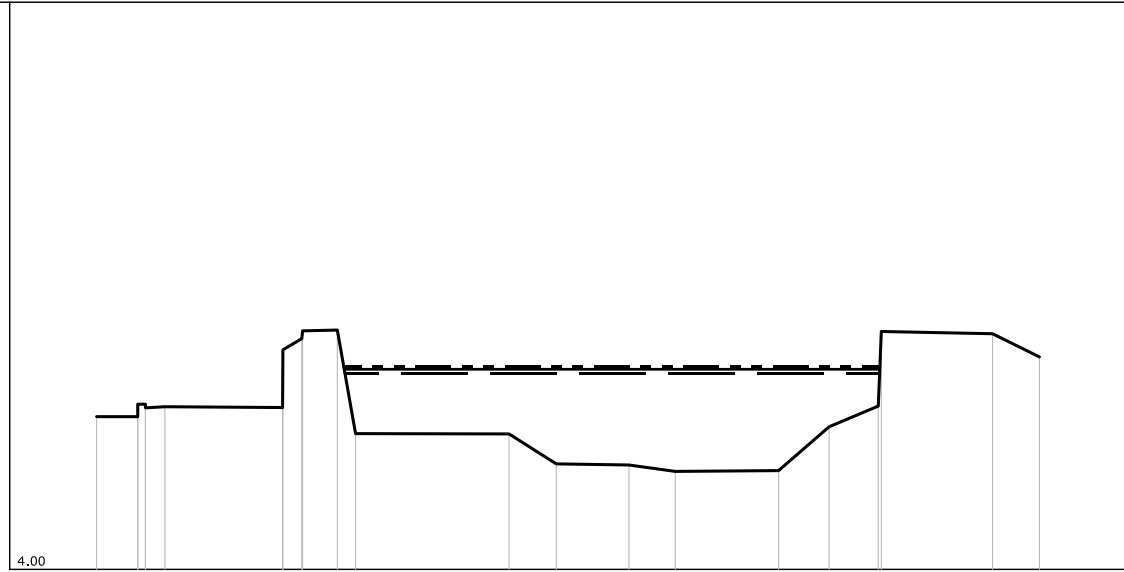

PUNTI	1	2	6	7	9	11	12	13	14	15	16	17	18	19	21	22
QUOTE [m s.l.m.]	8.04	8.04	8.30	8.28	10.10	10.33	7.59	7.58	6.79	6.76	6.59	6.61	7.77	8.32	10.23	9.62
DISTANZE PROGRESSIVE [m]	0.00	1.09	1.81	4.92	5.43	6.37	6.85	10.91	12.16	14.08	15.31	18.04	19.38	20.68	23.70	24.94
DISTANZE PARZIALI [m]	1.09			3.11				4.06	1.25	1.92	1.23	2.73	1.34	1.30	2.94	1.24

Torrente Parmignola  
 SEZIONE N° 00215\_\_13

LEGENDA:

TR30 H =9.06 m. s.l.m. \_\_\_\_\_

TR200 H =9.16 m. s.l.m. \_\_\_\_\_

TR500 H =9.23 m. s.l.m. - - - - -

SCALA DISTANZE 1:200  
 SCALA QUOTE 1:200

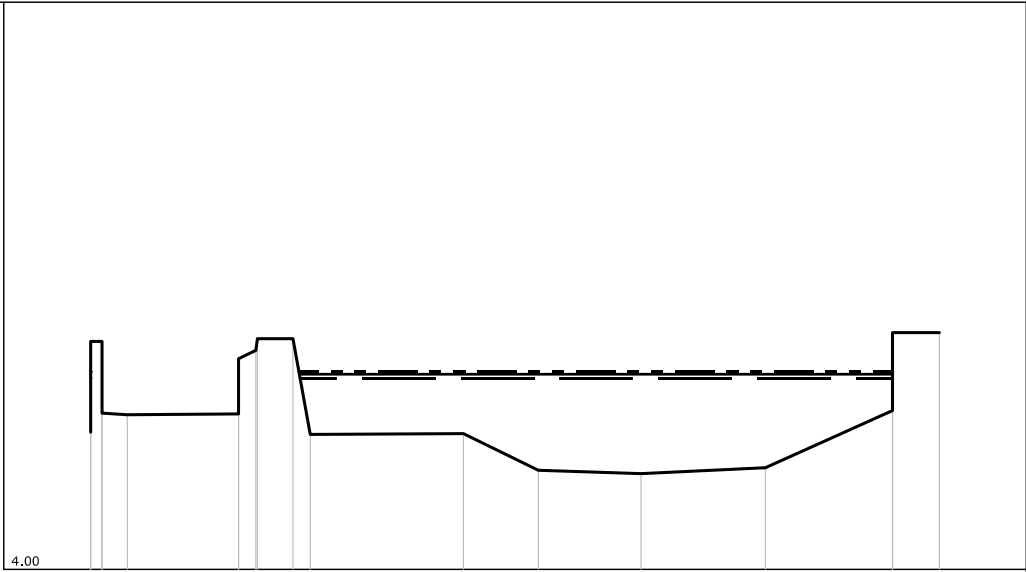

PUNTI	1	3	5	6	8	10	11	12	13	14	15	16	18
QUOTE [m s.l.m.]		7.63	10.03	8.09	8.11	9.79	10.10	7.59	6.62	6.53	6.69	8.20	10.26
DISTANZE PROGRESSIVE [m]	0.00	0.30	0.97	3.91	4.37	5.35	5.81	9.86	11.84	14.56	17.85	21.21	22.45
DISTANZE PARZIALI [m]				2.94				4.05	1.98	2.72	3.29	3.36	1.24

Torrente Parmignola  
SEZIONE N° 00212\_13

LEGENDA:

- TR30 H = 8.92 m. s.l.m.
- TR200 H = 9.03 m. s.l.m.
- TR500 H = 9.09 m. s.l.m.

SCALA DISTANZE 1:200  
SCALA QUOTE 1:200

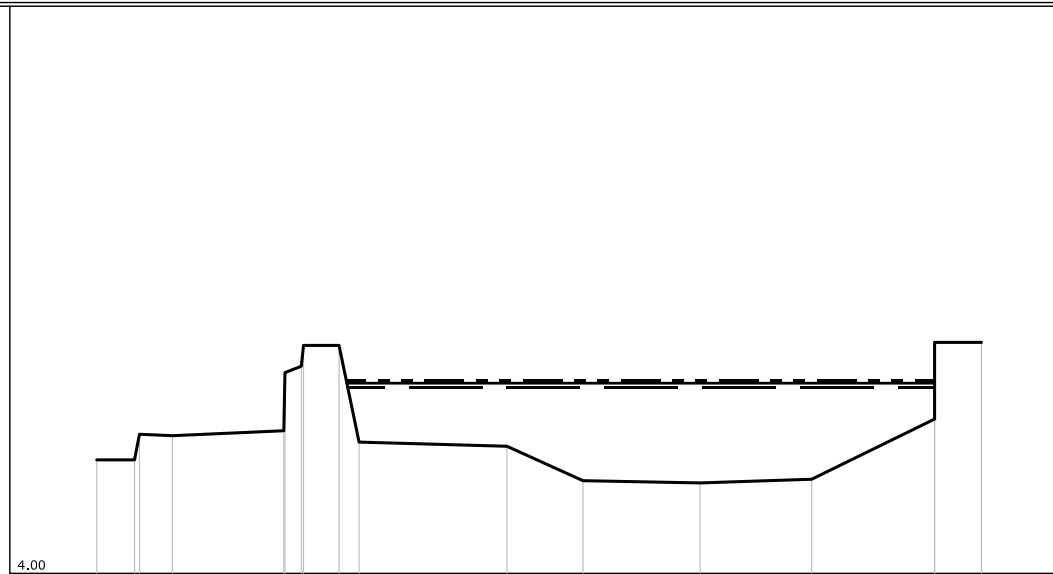

PUNTI	1	2	4	5	7	9	10	11	12	13	14	15	17
QUOTE [m s.l.m.]	7.00	7.00	7.64	7.77	9.48	10.03	7.47	7.36	6.45	6.39	6.49	8.08	10.11
DISTANZE PROGRESSIVE [m]	0.00	1.00	2.00	4.85	5.41	6.41	6.94	10.85	12.86	15.96	18.91	22.16	23.40
DISTANZE PARZIALI [m]	1.00		2.95					3.91	2.01	3.10	2.95	3.25	1.24



Torrente Parmignola  
SEZIONE N° 00209\_\_13

LEGENDA:

TR30 H =8.78 m. s.l.m. ———

TR200 H =8.88 m. s.l.m. ———

TR500 H =8.95 m. s.l.m. - - - - -

SCALA DISTANZE 1:200  
SCALA QUOTE 1:200

4.00

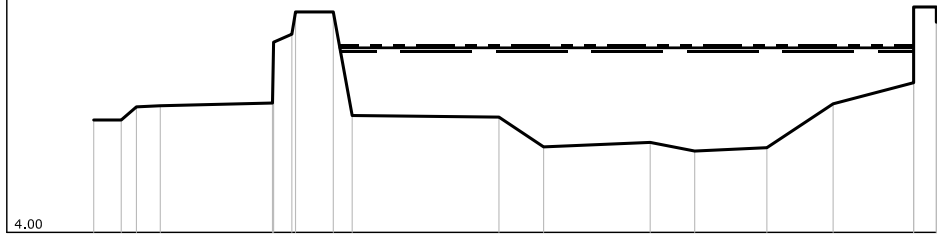

PUNTI	1	2	3	4	5	7	9	10	11	12	13	14	15	16	17	19
QUOTE [m s.l.m.]	6.97	6.97	7.32	7.35	7.42	9.24	9.83	7.09	7.05	6.26	6.38	6.15	6.24	7.40	7.96	9.96
DISTANZE PROGRESSIVE [m]	0.00	0.73	1.13	1.76	4.73	5.24	6.34	6.84	10.72	11.90	14.72	15.90	17.81	19.56	21.69	22.29
DISTANZE PARZIALI [m]					2.97		1.00		3.88	1.18	2.82	1.18	1.91	1.75	2.13	

Torrente Parmignola  
 SEZIONE N° 00206\_\_13

LEGENDA:

TR30 H = 8,64 m. s.l.m. ———

TR200 H = 8,74 m. s.l.m. ———

TR500 H = 8,80 m. s.l.m. - - - - -

SCALA DISTANZE 1:200  
 SCALA QUOTE 1:200

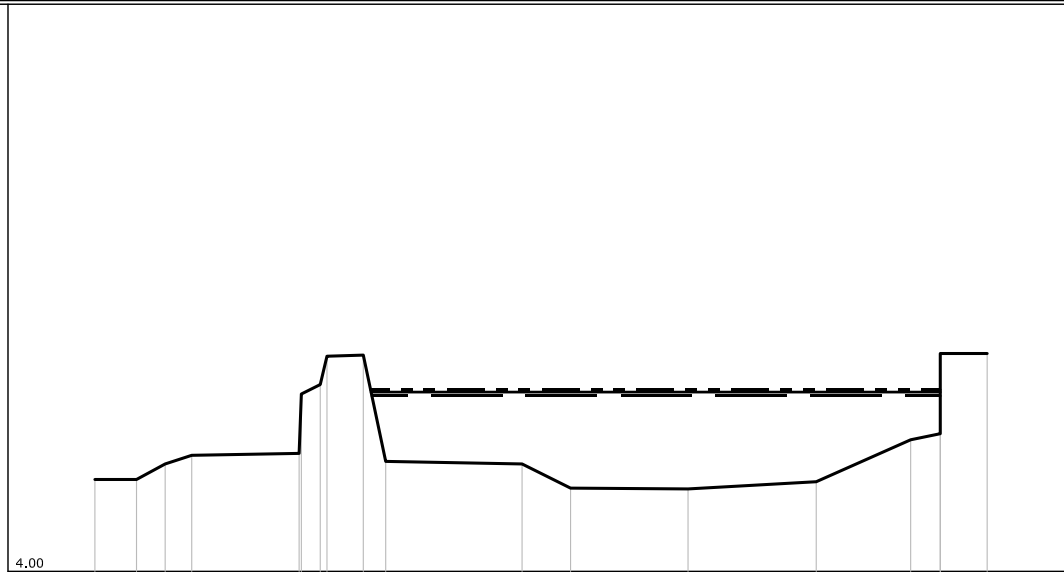

PUNTI	1	2	3	4	5	7	9	10	11	12	13	14	15	16	18
QUOTE [m s.l.m.]	6.43	6.43	6.84	7.07	7.12	8.94	9.72	6.91	6.84	6.20	6.18	6.37	7.48	7.64	9.76
DISTANZE PROGRESSIVE [m]	0.00	1.10	1.86	2.56	5.40	5.96	7.10	7.69	11.30	12.58	15.69	19.08	21.58	22.36	23.60
DISTANZE PARZIALI [m]	1.10			2.84				3.61	1.28	3.11	3.39	2.50	1.24		

Torrente Parmignola  
SEZIONE N° 00203\_\_13

LEGENDA:

TR30 H = 8.50 m. s.l.m. \_\_\_\_\_

TR200 H = 8.60 m. s.l.m. \_\_\_\_\_

TR500 H = 8.67 m. s.l.m. - - - - -

SCALA DISTANZE 1:200  
SCALA QUOTE 1:200

3.00

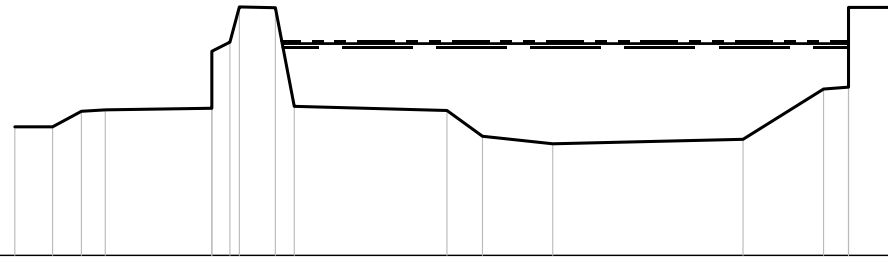

PUNTI	1	2	3	4	5	7	8	9	10	11	12	13	14	15	16	18
QUOTE [m s.l.m.]	6.40	6.40	6.81	6.85	6.89	8.64	8.67	9.55	6.94	6.83	6.15	5.95	6.07	7.40	7.45	9.56
DISTANZE PROGRESSIVE [m]	0.00	1.00	1.76	2.39	5.21	5.63	5.94	6.89	7.39	11.43	12.37	14.23	19.26	21.39	22.05	23.29
DISTANZE PARZIALI [m]	1.00			2.82					4.04		1.86	5.03	2.13	1.24		

Torrente Parmignola  
SEZIONE N° 00200\_\_13

LEGENDA:

TR30 H =8.36 m. s.l.m. ————

TR200 H =8.46 m. s.l.m. ————

TR500 H =8.52 m. s.l.m. - - - - -

SCALA DISTANZE 1:200  
SCALA QUOTE 1:200

3.00

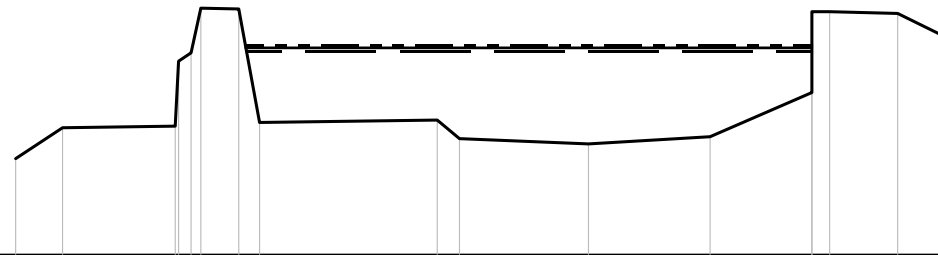



PUNTI	1	2	3	5	6	7	8	9	10	11	12	13	15	16	17
QUOTE [m s.l.m.]	5.53	6.35	6.39	8.33	8.31	9.49	6.49	6.55	6.06	5.92	6.11	7.28	9.42	9.37	8.76
DISTANZE PROGRESSIVE [m]	0.00	1.24	4.22	4.64	4.90	5.90	6.45	11.15	11.74	15.15	18.37	21.06	21.53	23.33	24.57
DISTANZE PARZIALI [m]		1.24	2.98			1.00		4.70		3.41	3.22	2.69		1.80	1.24

Torrente Parmignola  
SEZIONE N° 00197\_\_13

LEGENDA:

TR30 H = 8.22 m. s.l.m. 

TR200 H = 8.31 m. s.l.m. 

TR500 H = 8.38 m. s.l.m. 

SCALA DISTANZE 1:200  
SCALA QUOTE 1:200

3.00

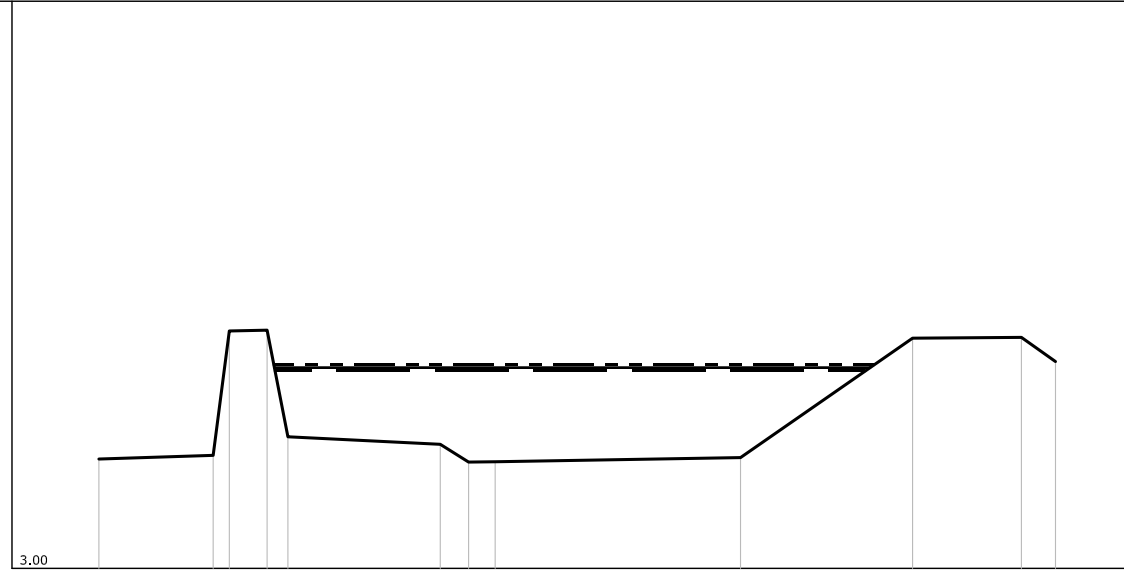

PUNTI	1	2	3	4	5	6	7	8	9	10	11	12
QUOTE [m s.l.m.]	5.89	5.99	9.28	9.30	6.48	6.28	5.81	5.82	5.93	9.09	9.11	8.47
DISTANZE PROGRESSIVE [m]	0.00	3.02	3.45	4.45	5.00	9.03	9.78	10.48	16.97	21.52	24.40	25.30
DISTANZE PARZIALI [m]		3.02	1.00		4.03				6.49	4.55	2.88	

Torrente Parmignola  
SEZIONE N° 00194\_\_13

LEGENDA:

TR30 H = 8.11 m. s.l.m. 

TR200 H = 8.21 m. s.l.m. 

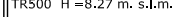
TR500 H = 8.27 m. s.l.m. 

SCALA DISTANZE 1:200  
SCALA QUOTE 1:200

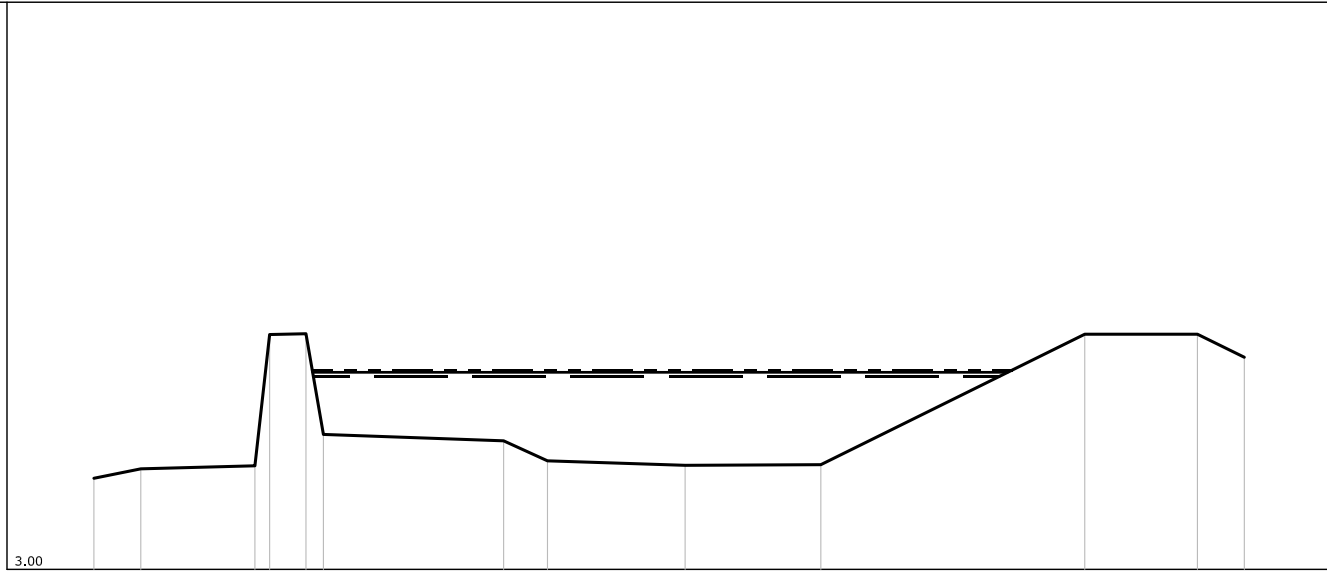

PUNTI	1	2	3	4	5	6	7	8	9	10	11	12	13
QUOTE [m s.l.m.]	5.41	5.66	5.74	9.21	9.23	6.57	6.40	5.87	5.75	5.77	9.22	9.22	8.61
DISTANZE PROGRESSIVE [m]	0.00	1.24	4.26	4.65	5.61	6.07	10.84	12.00	15.64	19.23	26.21	29.19	30.43
DISTANZE PARZIALI [m]		1.24	3.02				4.77	1.16	3.64	3.59	6.98	2.98	1.24

Torrente Parmignola  
SEZIONE N° 00191\_\_13

LEGENDA:

TR30 H = 8.00 m. s.l.m. ———

TR200 H = 8.10 m. s.l.m. ———

TR500 H = 8.16 m. s.l.m. - - - - -

SCALA DISTANZE 1:200  
SCALA QUOTE 1:200

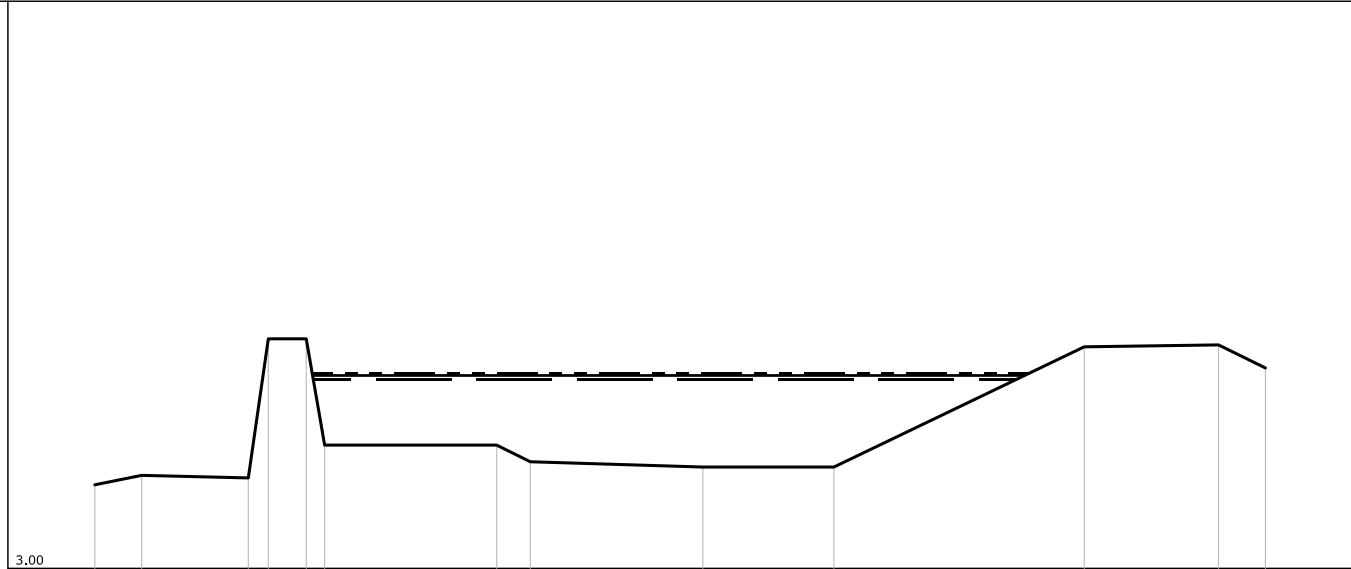



PUNTI	1	2	3	4	5	6	7	8	9	10	11	12	13
QUOTE [m s.l.m.]	5.21	5.46	5.39	9.07	9.07	6.26	6.26	5.82	5.68	5.68	8.86	8.91	8.30
DISTANZE PROGRESSIVE [m]	0.00	1.24	4.06	4.59	5.59	6.08	10.63	11.52	16.08	19.55	26.17	29.72	30.96
DISTANZE PARZIALI [m]	1.24	2.82	1.00		4.55		4.56	3.47	6.62	3.55	1.24		

Torrente ParmIgnola  
SEZIONE N° 00188\_\_13

LEGENDA:

TR30 H = 7.89 m. s.l.m. 

TR200 H = 7.99 m. s.l.m. 

TR500 H = 8.05 m. s.l.m. 

SCALA DISTANZE 1:200  
SCALA QUOTE 1:200

1.00

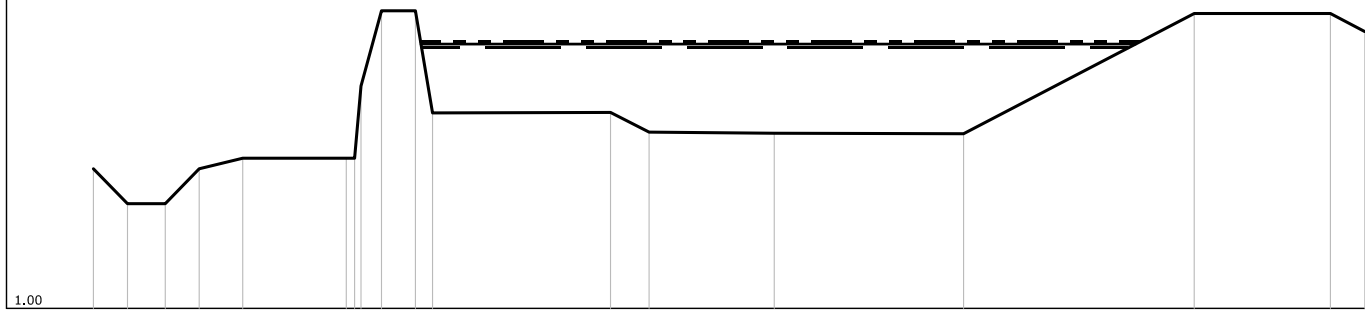

PUNTI	1	2	3	4	5	6	8	9	10	11	12	13	14	15	16	17	18
QUOTE [m s.l.m.]	4.69	3.77	3.77	4.69	4.97	4.97	6.88	8.87	8.87	6.17	6.18	5.66	5.63	5.62	8.80	8.80	8.32
DISTANZE PROGRESSIVE [m]	0.00	0.90	1.90	2.80	3.95	6.69	7.08	7.62	8.52	8.97	13.68	14.70	18.01	23.02	29.12	32.72	33.63
DISTANZE PARZIALI [m]		1.00	1.15	2.74							4.71	1.02	3.31	5.01	6.10	3.60	



Torrente Parmignola  
SEZIONE N° 00185\_\_13

LEGENDA:

- TR30 H =7.78 m. s.l.m.
- TR200 H =7.88 m. s.l.m.
- TR500 H =7.95 m. s.l.m.

SCALA DISTANZE 1:200  
SCALA QUOTE 1:200

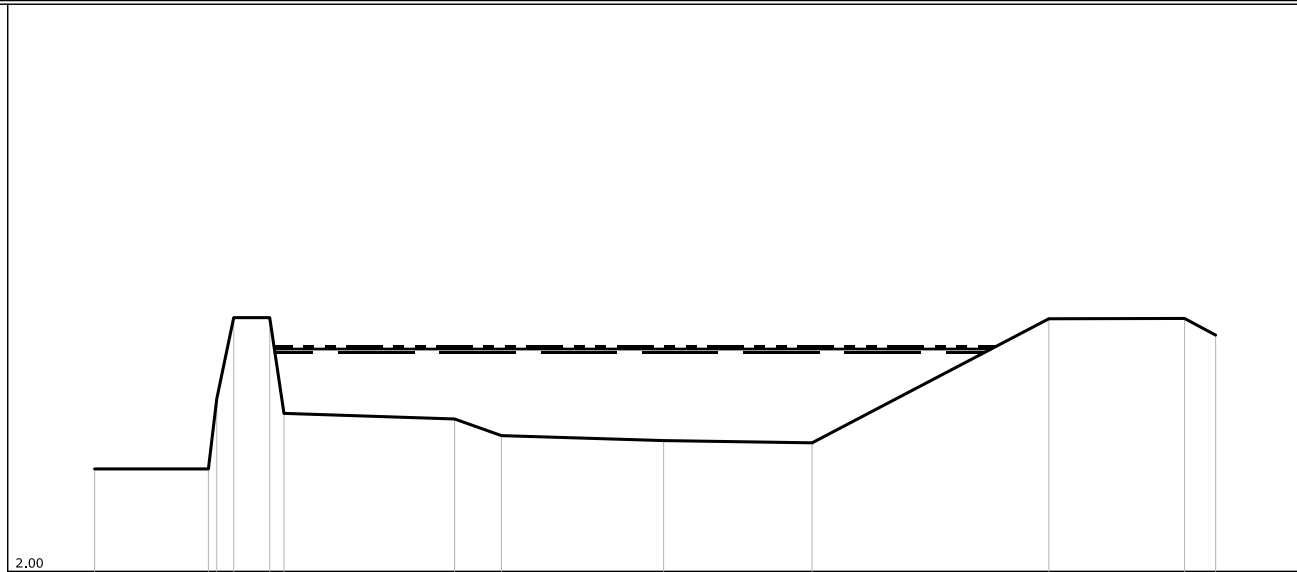

PUNTI	1	2	4	5	6	7	8	9	10	11	12	13
QUOTE [m s.l.m.]	4.71	4.71	8.71	8.71	6.18	6.03	5.59	5.46	5.40	8.68	8.69	8.25
DISTANZE PROGRESSIVE [m]	0.00	3.01	3.68	4.63	5.01	9.52	10.76	15.05	18.98	25.24	28.83	29.65
DISTANZE PARZIALI [m]		3.01				4.51	1.24	4.29	3.93	6.26	3.59	

Torrente Parmignola  
SEZIONE N° 00182\_\_13

LEGENDA:

TR30 H = 7.69 m. s.l.m. 

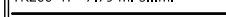
TR200 H = 7.79 m. s.l.m. 

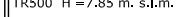
TR500 H = 7.85 m. s.l.m. 

SCALA DISTANZE 1:200  
SCALA QUOTE 1:200

2.00

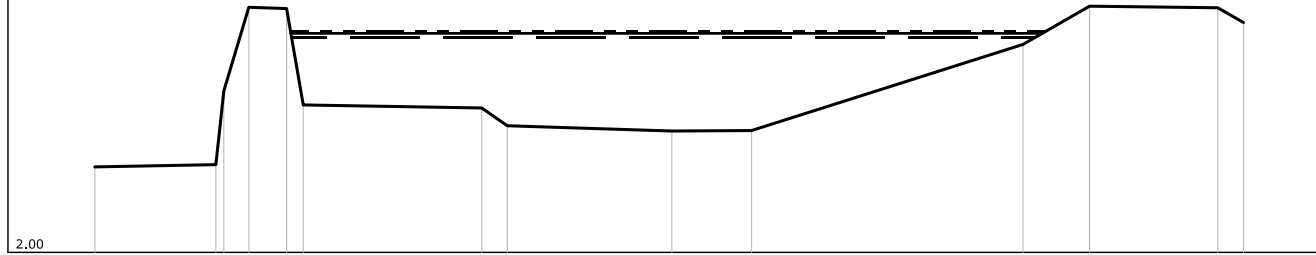

PUNTI	1	2	4	5	6	7	8	9	10	11	12	13	14
QUOTE [m s.l.m.]	4.26	4.32	8.48	8.45	5.90	5.82	5.35	5.21	5.22	7.50	8.51	8.47	8.08
DISTANZE PROGRESSIVE [m]	0.00	3.20	4.07	5.07	5.51	10.23	10.91	15.26	17.37	24.55	26.31	29.70	30.38
DISTANZE PARZIALI [m]		3.20	1.00		4.72		4.35	2.11	7.18	1.76	3.39		

Torrente Parmignola  
SEZIONE N° 00179\_\_13

LEGENDA:

TR30 H = 7.59 m. s.l.m. ———

TR200 H = 7.69 m. s.l.m. ———

TR500 H = 7.75 m. s.l.m. - - - - -

SCALA DISTANZE 1:200  
SCALA QUOTE 1:200

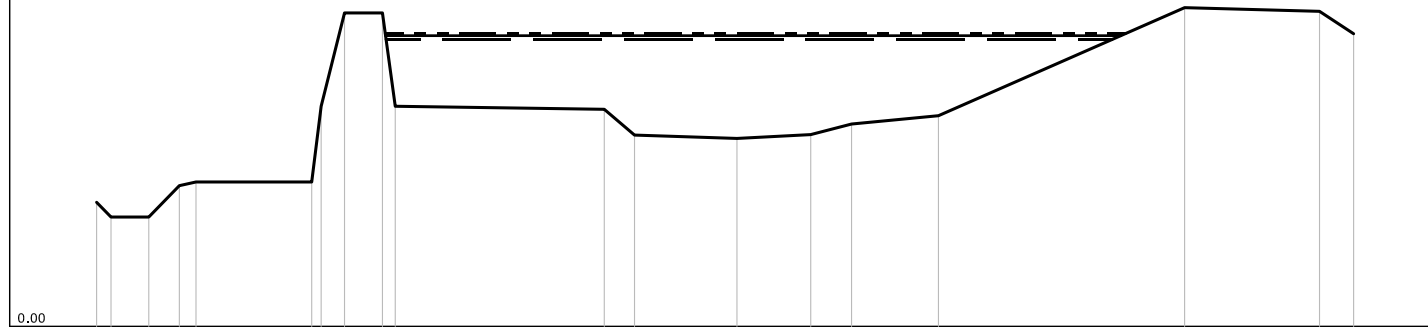

PUNTI	1	2	3	4	5	6	7	8	9	10	11	12	13	14	15	16	17	18	19
QUOTE [m s.l.m.]		3.28	2.89	2.89	3.72	3.82	3.82	8.29	8.29	5.82	5.74	5.06	4.97	5.07	5.35	5.57	8.43	8.33	7.74
DISTANZE PROGRESSIVE [m]	0.00	0.38	1.38	2.19	2.63	5.69	5.94	6.56	7.56	7.90	13.43	14.23	16.94	18.89	19.97	22.27	28.78	32.35	33.25
DISTANZE PARZIALI [m]		1.00			3.06			1.00		5.53		2.71	1.95	1.08	2.30	6.51	3.57		

Torrente Parmignola  
 SEZIONE N° 00176\_\_13

LEGENDA:

- TR30 H = 7.52 m. s.l.m.
- TR200 H = 7.61 m. s.l.m.
- TR500 H = 7.68 m. s.l.m.

SCALA DISTANZE 1:200  
 SCALA QUOTE 1:200

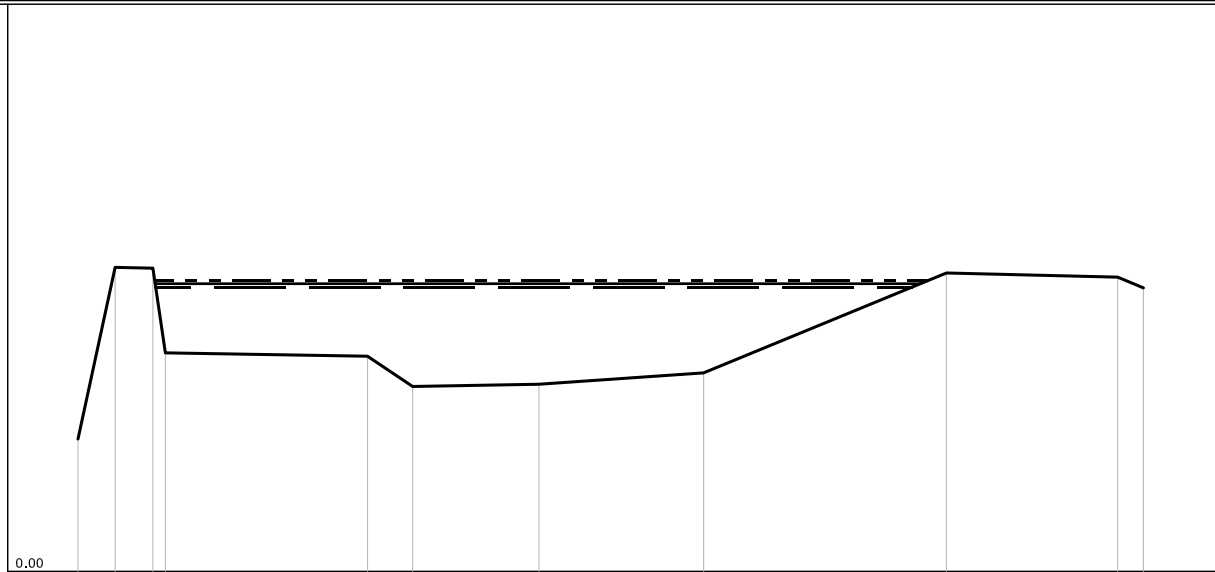

PUNTI	8	9	10	11	12	13	14	15	16	17	18
QUOTE [m s.l.m.]	3.50	8.04	8.02	5.78	5.69	4.89	4.95	5.25	7.89	7.78	7.50
DISTANZE PROGRESSIVE [m]	20.64	21.62	22.62	22.95	28.30	29.49	32.83	37.19	43.61	48.14	48.82
DISTANZE PARZIALI [m]	0.98	1.00		5.35	1.19	3.34	4.36	6.42	4.53		

Torrente Parmignola  
 SEZIONE N° 00173\_\_13

LEGENDA:

TR30 H =7.43 m. s.l.m. ———

TR200 H =7.53 m. s.l.m. ———

TR500 H =7.60 m. s.l.m. - - - - -

SCALA DISTANZE 1:200  
 SCALA QUOTE 1:200

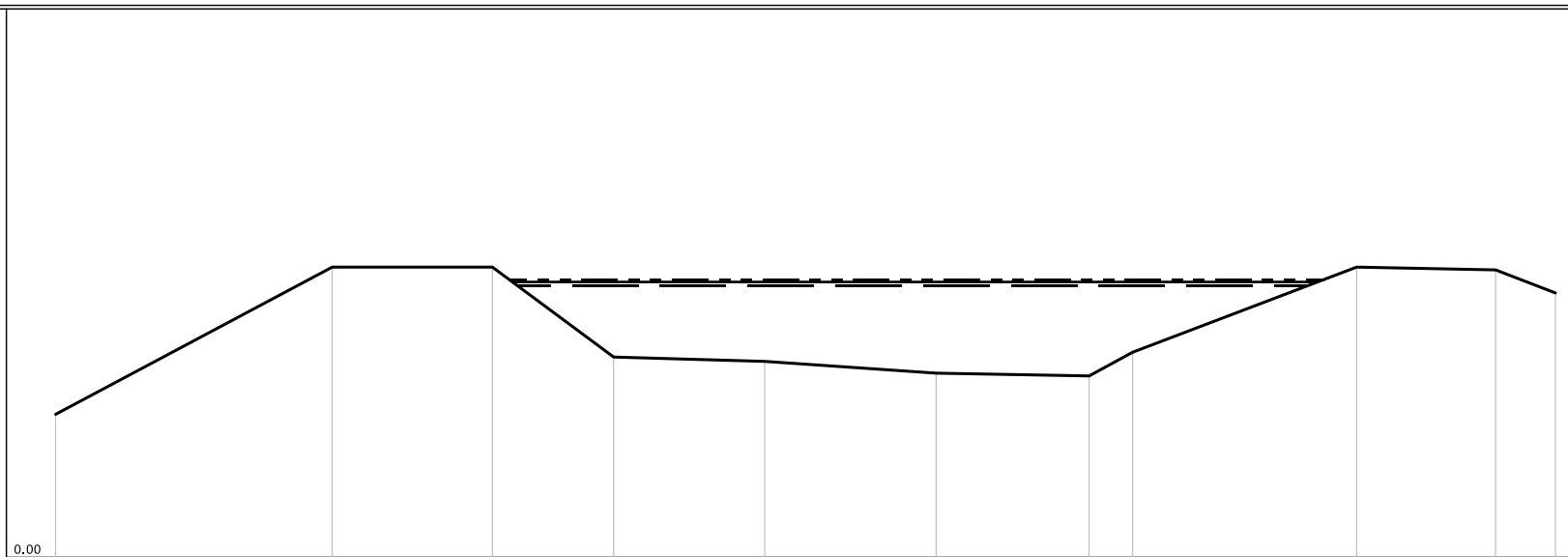

PUNTI	6	7	8	9	10	11	12	13	14	15	16
QUOTE [m s.l.m.]	3.91	7.94	7.94	5.48	5.36	5.04	4.96	5.61	7.94	7.86	7.23
DISTANZE PROGRESSIVE [m]	11.05	18.62	23.00	26.32	30.45	35.14	39.33	40.52	46.65	50.45	52.09
DISTANZE PARZIALI [m]		7.57	4.38	3.32	4.13	4.69	4.19	1.19	6.13	3.80	1.64

Torrente Parmignola  
SEZIONE N° 00170\_\_13

LEGENDA:

- TR30 H = 7.36 m. s.l.m.
- TR200 H = 7.46 m. s.l.m.
- TR500 H = 7.53 m. s.l.m.

SCALA DISTANZE 1:200  
SCALA QUOTE 1:200

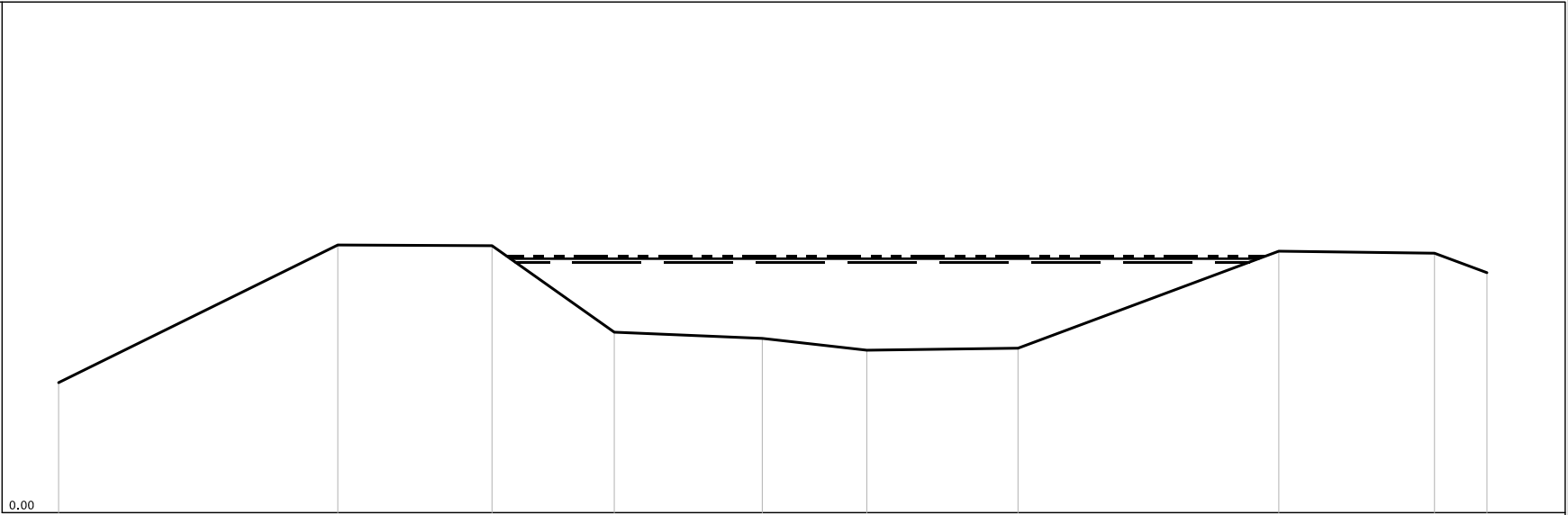

PUNTI	6	7	8	9	10	11	12	13	14	15
QUOTE [m s.l.m.]	3.82	7.86	7.84	5.30	5.12	4.77	4.83	7.68	7.62	7.05
DISTANZE PROGRESSIVE [m]	11.67	19.87	24.40	27.99	32.34	35.41	39.85	47.51	52.08	53.62
DISTANZE PARZIALI [m]		8.20	4.53	3.59	4.35	3.07	4.44	7.66	4.57	1.54

Torrente Parmignola  
SEZIONE N° 00167\_\_13

LEGENDA:

TR30 H = 7.27 m. s.l.m. ———

TR200 H = 7.37 m. s.l.m. ———

TR500 H = 7.43 m. s.l.m. - - - - -

SCALA DISTANZE 1:200  
SCALA QUOTE 1:200

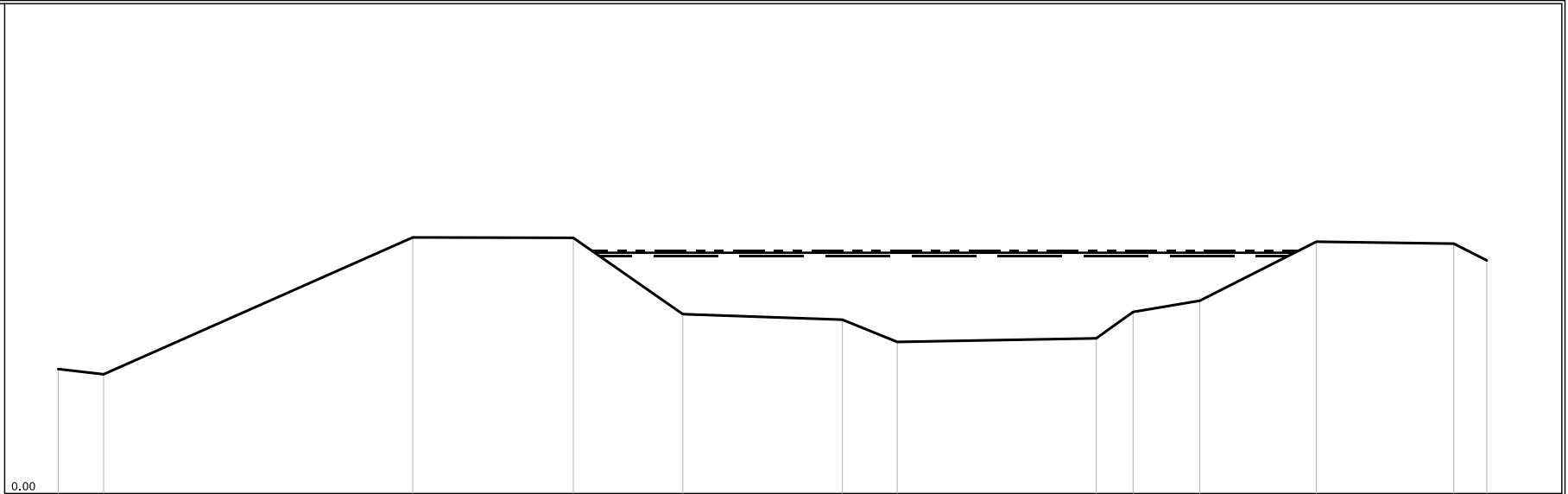

PUNTI	6	7	8	9	10	11	12	13	14	15	16	17	18
QUOTE [m s.l.m.]	3.81	3.65	7.84	7.83	5.49	5.32	4.64	4.75	5.56	5.90	7.71	7.65	7.14
DISTANZE PROGRESSIVE [m]	9.86	11.25	20.72	25.64	28.99	33.88	35.56	41.66	42.79	44.83	48.40	52.61	53.62
DISTANZE PARZIALI [m]	1.39	9.47	4.92	3.35	4.89	1.68	6.10	1.13	2.04	3.57	4.21	1.01	

Torrente Parmignola  
SEZIONE N° 00164\_13

LEGENDA:

TR30 H = 7.16 m. s.l.m. \_\_\_\_\_

TR200 H = 7.25 m. s.l.m. \_\_\_\_\_

TR500 H = 7.32 m. s.l.m. - - - - -

SCALA DISTANZE 1:200  
SCALA QUOTE 1:200

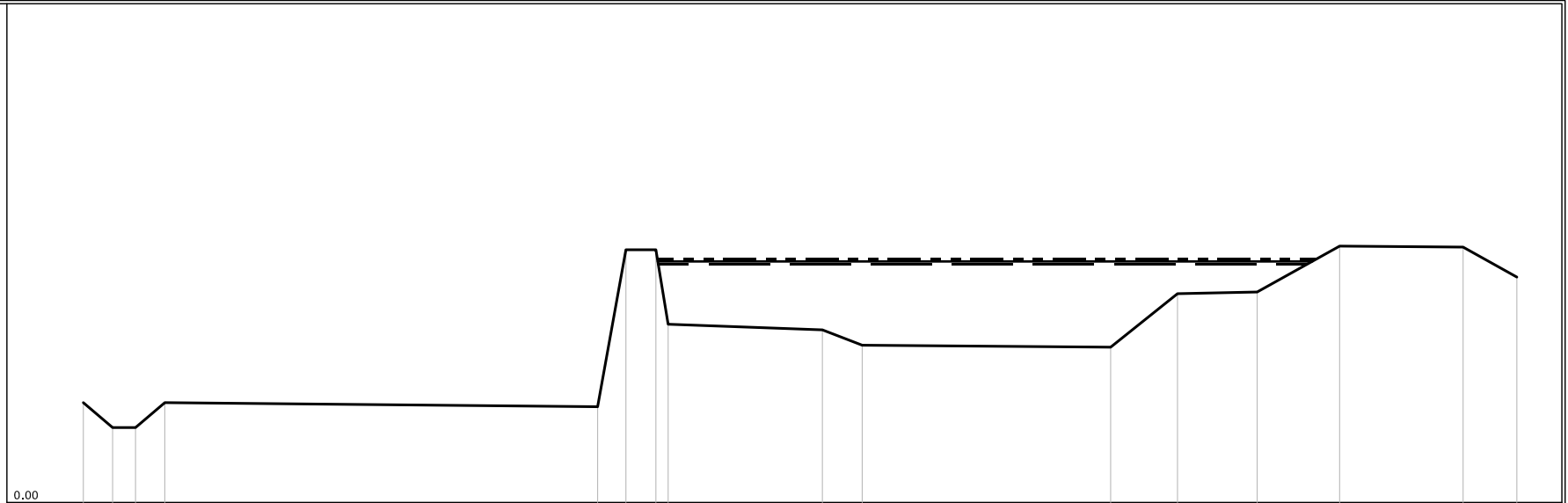

PUNTI	1	2	3	4	5	6	7	8	9	10	11	12	13	14	15	16
QUOTE [m s.l.m.]	3.00	2.25	2.25	3.00	2.88	7.60	7.60	5.36	5.19	4.73	4.67	6.28	6.33	7.71	7.68	6.78
DISTANZE PROGRESSIVE [m]	0.00	0.88	1.57	2.45	15.47	16.32	17.22	17.59	22.23	23.43	30.90	32.91	35.31	37.79	41.50	43.12
DISTANZE PARZIALI [m]					13.02				4.64	1.20	7.47	2.01	2.40	2.48	3.71	1.62



Torrente Parmignola  
SEZIONE N° 00161\_\_13

LEGENDA:

TR30 H =7.06 m. s.l.m. ———

TR200 H =7.16 m. s.l.m. ———

TR500 H =7.22 m. s.l.m. - - - - -

SCALA DISTANZE 1:200  
SCALA QUOTE 1:200

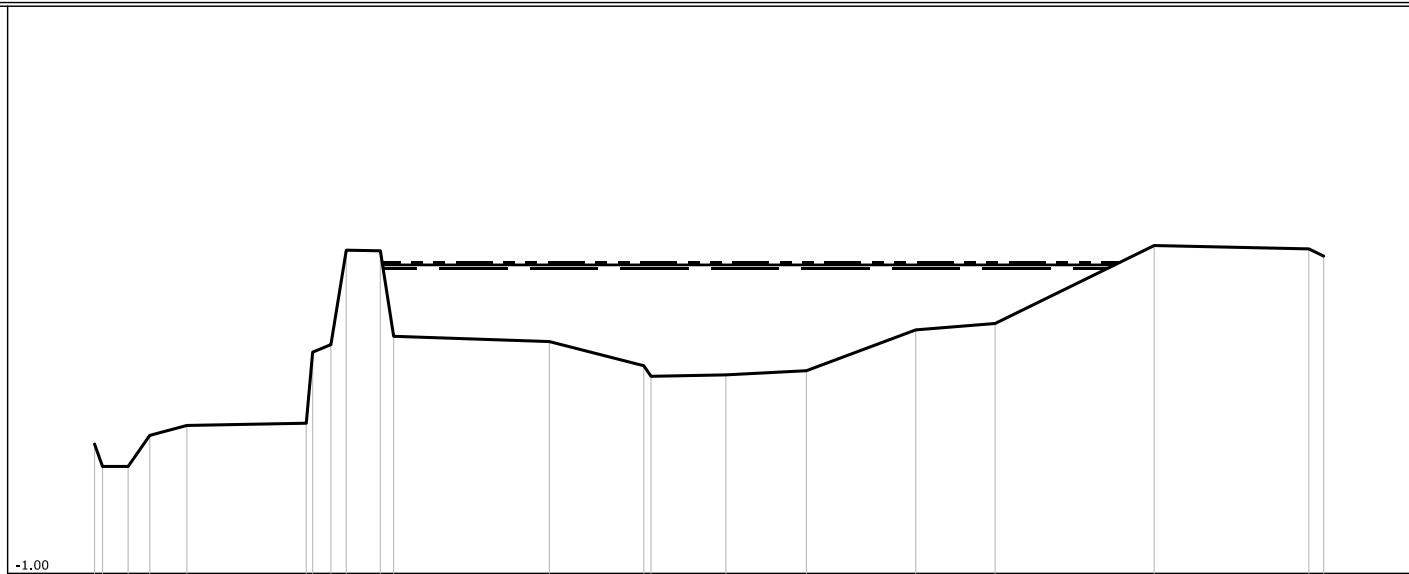

PUNTI	1	3	4	5	6	8	9	10	11	12	13	15	16	17	18	19	20	21
QUOTE [m s.l.m.]	2.42	1.83	2.65	2.91	2.97	5.05	7.55	7.53	5.27	5.13	4.49	4.25	4.36	5.44	5.61	7.67	7.58	7.39
DISTANZE PROGRESSIVE [m]	0.00	0.89	1.46	2.44	5.60	6.25	6.66	7.56	7.91	12.03	14.53	16.70	18.83	21.72	23.82	28.03	32.12	32.51
DISTANZE PARZIALI [m]			0.98	3.16						4.12	2.50	1.98	2.13	2.89	2.10	4.21	4.09	

Torrente Parmignola  
SEZIONE N° 00158\_\_13

LEGENDA:

TR30 H =6.97 m. s.l.m. ———

TR200 H =7.06 m. s.l.m. ———

TR500 H =7.12 m. s.l.m. - - - - -

SCALA DISTANZE 1:200  
SCALA QUOTE 1:200

-1.00

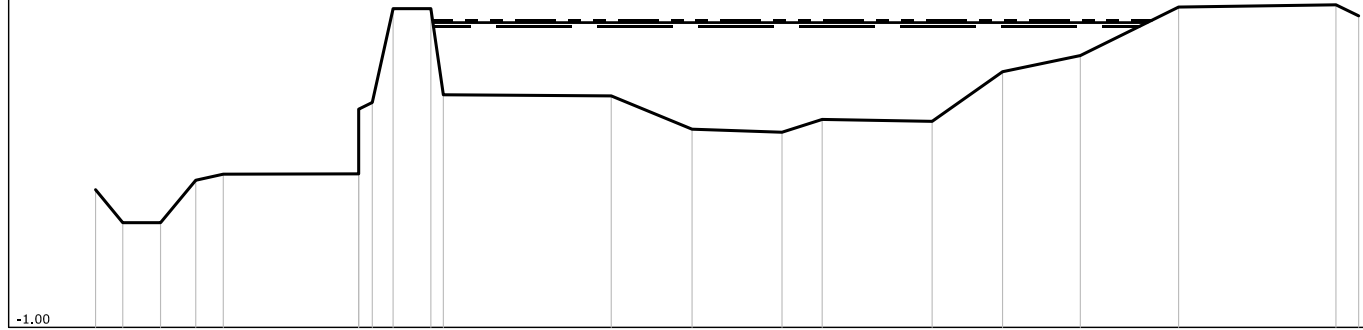

PUNTI	1	2	3	4	5	6	8	9	10	11	12	13	14	15	16	17	18	19	20	21
QUOTE [m s.l.m.]	2.64	1.77	1.77	2.89	3.05	3.06	4.95	7.43	7.43	5.15	5.12	4.24	4.16	4.50	4.45	5.76	6.19	7.47	7.53	7.24
DISTANZE PROGRESSIVE [m]	0.00	0.72	1.72	2.65	3.38	6.96	7.32	7.87	8.87	9.20	13.64	15.78	18.16	19.22	22.13	23.99	26.05	28.65	32.81	33.41
DISTANZE PARZIALI [m]		1.00			3.58		1.00		4.44	2.14	2.38	1.06	2.91	1.86	2.06	2.60		4.16		

Torrente Parmignola  
SEZIONE N° 00155\_\_13

LEGENDA:

- TR30 H =6.85 m. s.l.m.
- TR200 H =6.94 m. s.l.m.
- TR500 H =6.99 m. s.l.m.

SCALA DISTANZE 1:200  
SCALA QUOTE 1:200

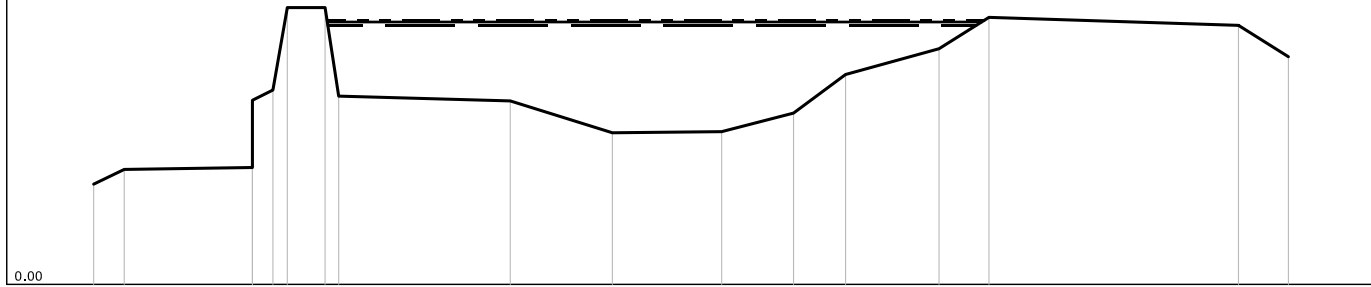

PUNTI	1	2	3	5	6	7	8	9	10	11	12	13	14	15	16	17
QUOTE [m s.l.m.]	2.65	3.04	3.09	5.14	7.32	7.32	4.98	4.85	4.01	4.04	4.53	5.55	6.23	7.06	6.85	6.02
DISTANZE PROGRESSIVE [m]	0.00	0.81	4.20	4.74	5.12	6.12	6.48	11.02	13.72	16.61	18.51	19.89	22.36	23.68	30.28	31.60
DISTANZE PARZIALI [m]			3.39		1.00		4.54	2.70	2.89	1.90	1.38	2.47	1.32	6.60	1.32	

Torrente Parmignola  
SEZIONE N° 00152\_\_13

LEGENDA:

TR30 H =6.66 m. s.l.m. ———

TR200 H =6.75 m. s.l.m. ———

TR500 H =6.80 m. s.l.m. - - - - -

SCALA DISTANZE 1:200  
SCALA QUOTE 1:200

0.00

PUNTI	1	2	3	6	7	8	9	10	11	12	14	15	16	17	18	19	20	21
QUOTE [m s.l.m.]	2.76	3.15	3.17	5.24	7.23	7.23	4.69	4.36	4.11	4.13	3.64	3.80	4.49	5.47	6.05	7.11	7.08	6.55
DISTANZE PROGRESSIVE [m]	0.00	0.81	4.06	4.69	4.98	5.98	6.43	10.40	11.10	11.68	12.93	14.70	16.13	16.93	18.77	20.86	24.28	25.33
DISTANZE PARZIALI [m]			3.25		1.00		3.97				1.02	1.77	1.43		1.84	2.09	3.42	1.05

Torrente Parmignola  
SEZIONE N° 00149\_\_13

LEGENDA:

TR30 H =6.57 m. s.l.m. ———

TR200 H =6.65 m. s.l.m. ———

TR500 H =6.70 m. s.l.m. - - - - -

SCALA DISTANZE 1:200  
SCALA QUOTE 1:200

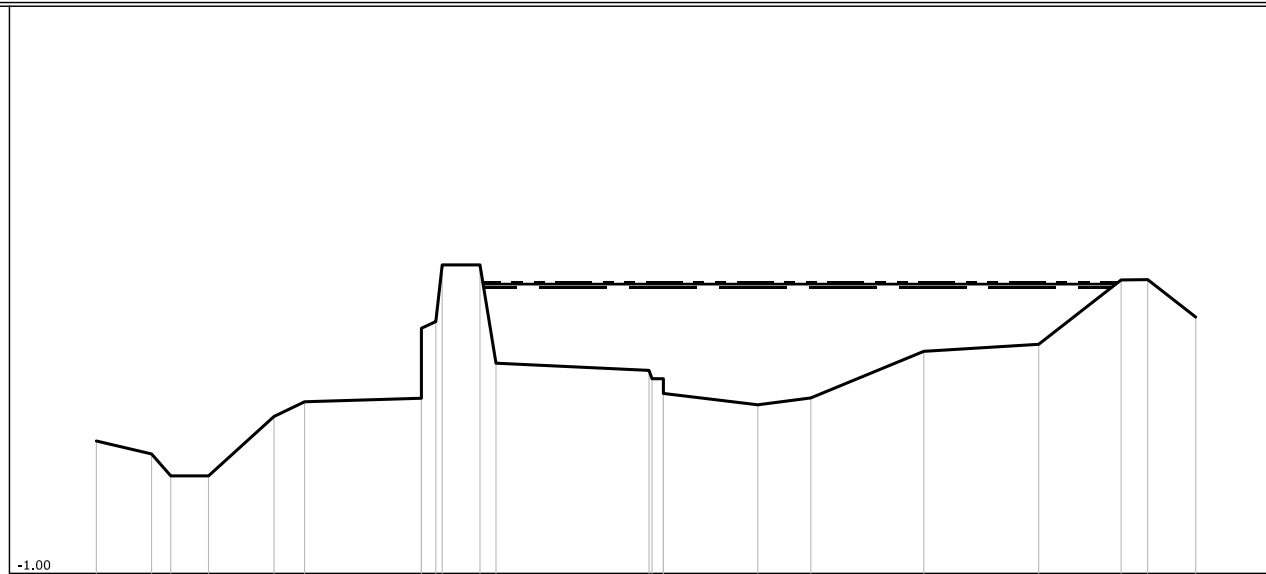

PUNTI	1	2	3	4	5	6	7	9	11	12	13	15	17	18	19	20	21	22	23
QUOTE [m s.l.m.]	2.50	2.16	1.58	1.58	3.15	3.54	3.63	5.66	7.16	4.56	4.37	4.15	3.46	3.64	4.87	5.06	6.76	6.77	5.78
DISTANZE PROGRESSIVE [m]	0.00	1.46	1.97	2.97	4.70	5.51	8.60	8.98	10.15	10.37	14.62	15.00	17.50	18.90	21.89	24.93	27.11	27.81	29.08
DISTANZE PARZIALI [m]		1.46	1.00	1.73		3.09		1.00		4.05		2.50	1.40	2.99	3.04	2.18		1.27	

Torrente Parmignoia  
SEZIONE N° 00146\_\_13

LEGENDA:

TR30 H =6.46 m. s.l.m. ———

TR200 H =6.54 m. s.l.m. ———

TR500 H =6.58 m. s.l.m. - - - - -

SCALA DISTANZE 1:200  
SCALA QUOTE 1:200

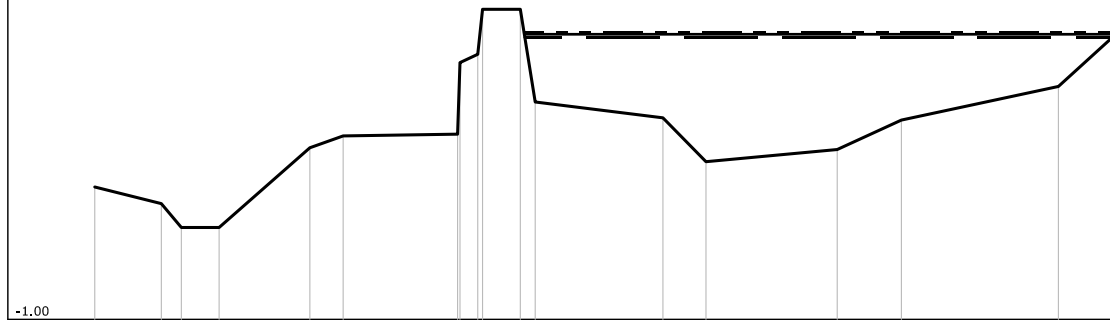

PUNTI	1	2	3	4	5	6	7	9	11	12	13	14	15	16	17	18
QUOTE [m s.l.m.]	2.50	2.06	1.43	1.43	3.54	3.85	3.90	6.01	7.20	4.75	4.33	3.17	3.49	4.27	5.16	6.77
DISTANZE PROGRESSIVE [m]	0.00	1.76	2.29	3.29	5.69	6.57	9.60	10.13	11.26	11.65	15.03	16.17	19.64	21.34	25.49	27.26
DISTANZE PARZIALI [m]		1.76	1.00	2.40		3.03		1.00		3.38	1.14	3.47	1.70	4.15	1.77	

Torrente Parmignola  
 SEZIONE N° 00143\_\_13

LEGENDA:

TR30 H =6.35 m. s.l.m. ————

TR200 H =6.42 m. s.l.m. ————

TR500 H =6.45 m. s.l.m. - - - - -

SCALA DISTANZE 1:200  
 SCALA QUOTE 1:200

1.00

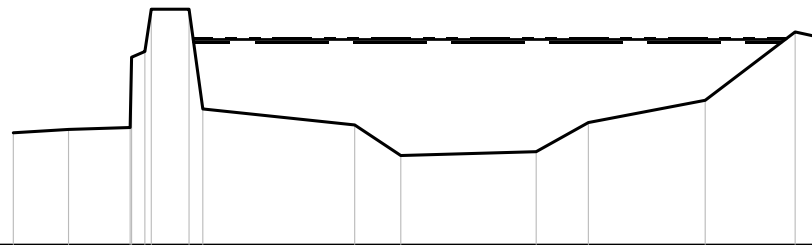

PUNTI	1	2	3	5	7	8	9	10	11	12	13	14	15
QUOTE [m s.l.m.]	3.95	4.04	4.09	6.10	7.22	4.38	4.16	3.35	3.45	4.22	4.81	6.62	6.47
DISTANZE PROGRESSIVE [m]	0.00	1.46	3.09	3.48	4.65	5.01	9.03	10.25	13.83	15.21	18.30	20.68	21.36
DISTANZE PARZIALI [m]		1.46	1.63	1.00		4.02	1.22	3.58	1.38	3.09	2.38		

Torrente Parmignola  
SEZIONE N° 00140\_13

LEGENDA:

TR30 H = 6.22 m. s.l.m. ———

TR200 H = 6.28 m. s.l.m. ———

TR500 H = 6.31 m. s.l.m. - - - - -

SCALA DISTANZE 1:200  
SCALA QUOTE 1:200

1.00

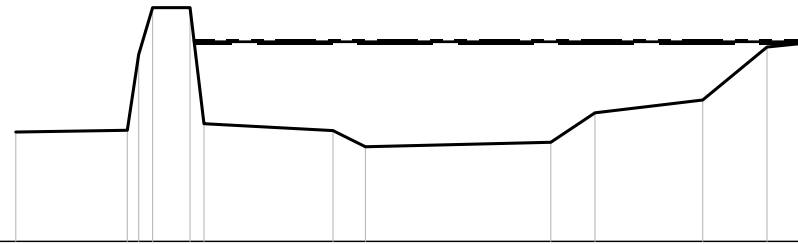



PUNTI	1	2	3	4	5	6	7	8	9	10	11	12	13
QUOTE [m s.l.m.]	3.89	3.94	5.94	7.18	7.18	4.11	3.93	3.50	3.62	4.40	4.74	6.14	6.24
DISTANZE PROGRESSIVE [m]	0.00	2.95	3.25	3.62	4.61	4.98	8.39	9.25	14.15	15.32	18.17	19.87	20.86
DISTANZE PARZIALI [m]		2.95		0.99		3.41			4.90	1.17	2.85	1.70	0.99



Torrente Parmignola  
SEZIONE N° 00137\_\_13

LEGENDA:

TR30 H = 6.09 m. s.l.m. 

TR200 H = 6.13 m. s.l.m. 

TR500 H = 6.16 m. s.l.m. 

SCALA DISTANZE 1:200  
SCALA QUOTE 1:200

1.00

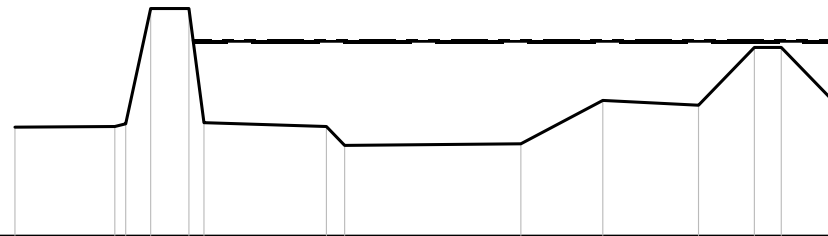



PUNTI	1	2	3	4	5	6	7	8	9	10	11	12	13	14
QUOTE [m s.l.m.]	3.86	3.88	3.95	7.00	7.00	3.98	3.88	3.38	3.42	4.57	4.44	5.97	5.97	4.44
DISTANZE PROGRESSIVE [m]	0.00	2.64	2.83	3.59	4.60	5.00	8.24	8.72	13.38	15.55	18.08	19.56	20.27	21.75
DISTANZE PARZIALI [m]		2.64		1.01		3.24			4.66	2.17	2.53	1.48		1.48

Torrente Parmignola  
SEZIONE N° 00134PA13

LEGENDA:

TR30 H = 5.98 m. s.l.m. 

TR200 H = 6.02 m. s.l.m. 

TR500 H = 6.05 m. s.l.m. 

SCALA DISTANZE 1:200  
SCALA QUOTE 1:200

1.00

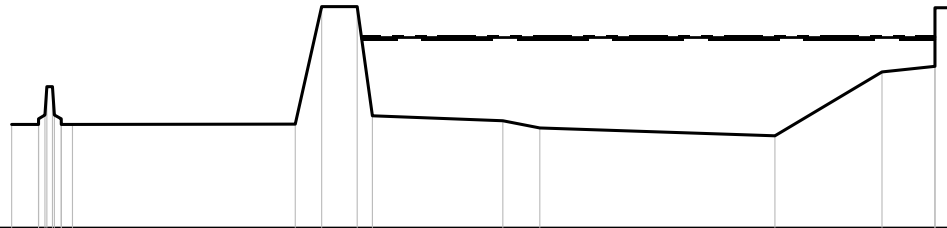

PUNTI	1	2	6	10	11	12	13	14	15	16	17	18	19	21
QUOTE [m s.l.m.]	3.72	3.72	4.72	3.72	3.73	6.84	6.84	3.95	3.82	3.63	3.42	5.11	5.26	6.81
DISTANZE PROGRESSIVE [m]	0.00	0.71	1.08	1.61	7.50	8.20	9.14	9.54	12.99	13.97	20.19	23.02	24.42	24.78
DISTANZE PARZIALI [m]					5.89				3.45	0.98	6.22	2.83	1.40	

Torrente ParmIgnola  
SEZIONE N° 00134PB13

LEGENDA:

- TR30 H =5.95 m. s.l.m.
- TR200 H =6.00 m. s.l.m.
- TR500 H =6.03 m. s.l.m.

SCALA DISTANZE 1:200  
SCALA QUOTE 1:200

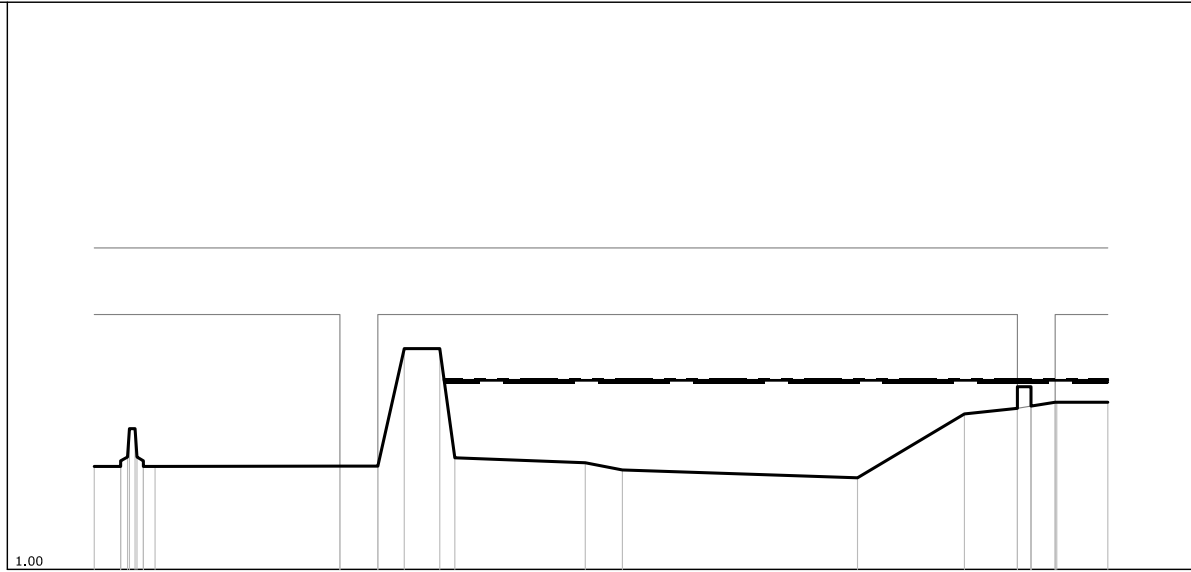

PUNTI	1	2	6	10	11	13	15	16	17	18	19	20	21	22	24	27	30
QUOTE [m s.l.m.]	3.72	3.72	4.72	3.72	3.73	3.73	6.84	6.84	3.95	3.82	3.63	3.42	5.11	5.26	5.83	5.42	5.42
DISTANZE PROGRESSIVE [m]	0.00	0.70	1.08	1.61	6.50	7.50	8.20	9.14	9.54	12.99	13.97	20.19	23.02	24.42	24.78	25.42	26.81
DISTANZE PARZIALI [m]					4.89	1.00				3.45	0.98	6.22	2.83	1.40		1.35	

Torrente ParmIgnola  
SEZIONE N° 00134PC13

LEGENDA:

TR30 H = 5.84 m. s.l.m. ———

TR200 H = 5.89 m. s.l.m. ———

TR500 H = 5.92 m. s.l.m. - - - - -

SCALA DISTANZE 1:200  
SCALA QUOTE 1:200

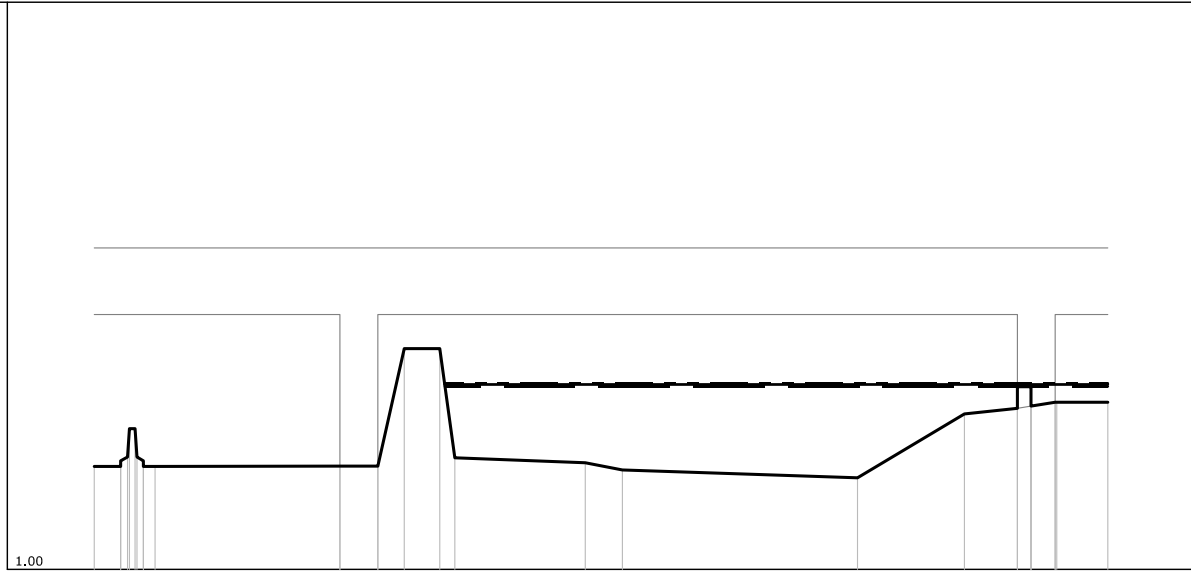

PUNTI	1	2	6	10	11	13	15	16	17	18	19	20	21	22	24	27	30
QUOTE [m s.l.m.]	3.72	3.72	4.72	3.72	3.73	3.73	6.84	6.84	3.95	3.82	3.63	3.42	5.11	5.26	5.83	5.42	5.42
DISTANZE PROGRESSIVE [m]	0.00	0.70	1.08	1.61	6.50	7.50	8.20	9.14	9.54	12.99	13.97	20.19	23.02	24.42	24.78	25.42	26.81
DISTANZE PARZIALI [m]					4.89	1.00				3.45	0.98	6.22	2.83	1.40		1.35	

Torrente Parmignola  
SEZIONE N° 00134PD13

LEGENDA:

TR30 H =5.84 m. s.l.m. ———

TR200 H =5.89 m. s.l.m. ———

TR500 H =5.92 m. s.l.m. - - - - -

SCALA DISTANZE 1:200  
SCALA QUOTE 1:200

1.00

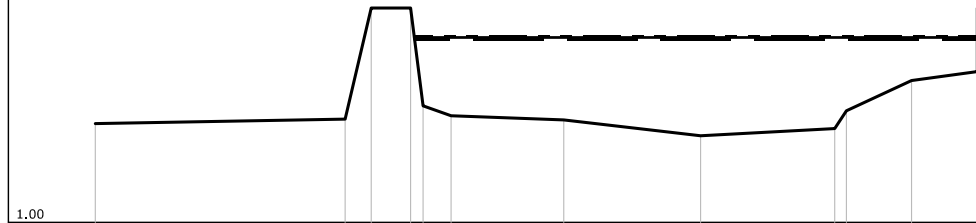

PUNTI	1	2	3	4	5	6	7	8	9	10	11	12	14					
QUOTE [m s.l.m.]	3.61		3.73	6.67	6.67	4.06	3.82		3.71		3.29		3.48	3.95	4.75		4.99	6.67
DISTANZE PROGRESSIVE [m]	0.00		6.61	7.30	8.54	8.67	9.41		12.39		16.01		19.56	19.87	21.59		23.33	23.69
DISTANZE PARZIALI [m]		6.61		1.04			2.98		3.62		3.55		1.72		1.74			

Torrente Parmignola  
SEZIONE N° 00128\_\_13

LEGENDA:

TR30 H = 5.65 m. s.l.m. ———

TR200 H = 5.71 m. s.l.m. ———

TR500 H = 5.74 m. s.l.m. - - - - -

SCALA DISTANZE 1:200  
SCALA QUOTE 1:200

1.00

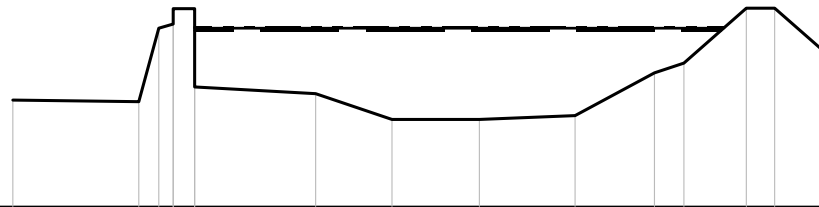

PUNTI	1	2	3	4	6	8	9	10	11	12	13	14	15	16
QUOTE [m s.l.m.]	3.81	3.77	5.71	5.82	6.23	3.98	3.30	3.30	3.40	4.53	4.79	6.24	6.24	5.16
DISTANZE PROGRESSIVE [m]	0.00	3.33	3.86	4.24	4.81	8.01	10.03	12.34	14.87	16.97	17.75	19.40	20.15	21.38
DISTANZE PARZIALI [m]		3.33				3.20	2.02	2.31	2.53	2.10	1.65		1.23	

Torrente Parmignola  
SEZIONE N° 00125\_\_13

LEGENDA:

- TR30 H = 5.50 m. s.l.m.
- TR200 H = 5.55 m. s.l.m.
- TR500 H = 5.57 m. s.l.m.

SCALA DISTANZE 1:200  
SCALA QUOTE 1:200

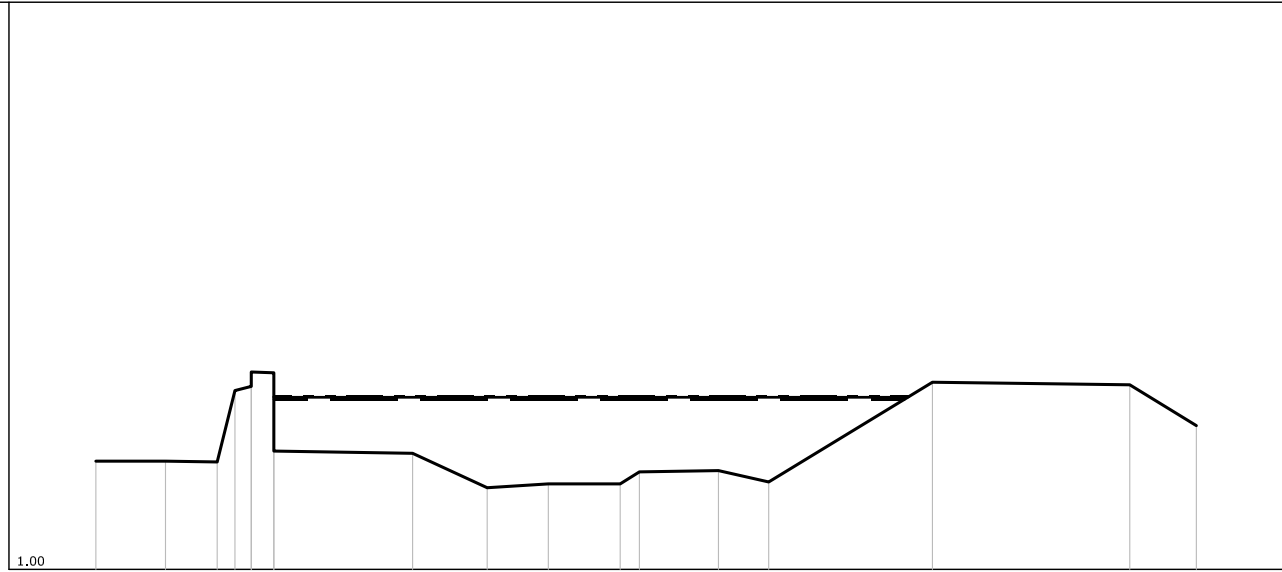

PUNTI	1	2	3	4	5	7	9	10	11	12	13	14	15	16	17	18
QUOTE [m s.l.m.]	3.86	3.86	3.84	5.73	5.84	6.20	4.07	3.16	3.26	3.26	3.58	3.61	3.31	5.95	5.88	4.80
DISTANZE PROGRESSIVE [m]	0.00	1.84	3.21	3.68	4.11	4.71	8.38	10.35	11.97	13.87	14.38	16.47	17.80	22.13	27.35	29.11
DISTANZE PARZIALI [m]		1.84	1.37				3.67	1.97	1.62	1.90		2.09	1.33	4.33	5.22	1.76

Torrente Parmignola  
SEZIONE N° 00122\_\_13

LEGENDA:

TR30 H = 5.38 m. s.l.m. ———

TR200 H = 5.42 m. s.l.m. ———

TR500 H = 5.45 m. s.l.m. - - - - -

SCALA DISTANZE 1:200  
SCALA QUOTE 1:200



PUNTI	1	2	3	4	6	8	9	10	11	12	13	14	15	16
QUOTE [m s.l.m.]	3.75	3.80	5.65	5.73	6.07	4.19	3.37	2.93	2.96	3.33	3.36	5.93	5.93	4.97
DISTANZE PROGRESSIVE [m]	0.00	3.42	3.94	4.30	4.87	10.65	13.51	14.05	17.82	18.10	21.50	24.62	30.22	31.38
DISTANZE PARZIALI [m]		3.42				5.78	2.86		3.77		3.40	3.12	5.60	1.16



Torrente Parmignola  
 SEZIONE N° 00119\_\_13

LEGENDA:

TR30 H = 5.28 m. s.l.m. ———

TR200 H = 5.33 m. s.l.m. ———

TR500 H = 5.35 m. s.l.m. - - - - -

SCALA DISTANZE 1:200  
 SCALA QUOTE 1:200

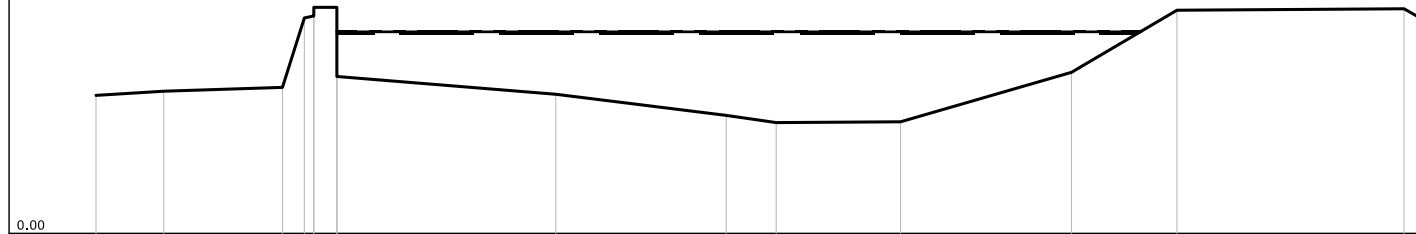

PUNTI	1	2	3	4	5	6	7	8	9	10	11	12	13	14	15	16
QUOTE [m s.l.m.]	3.65	3.76	3.86	5.70	5.70	5.70	5.98		3.68	3.12	2.93	2.95	4.26	5.90		5.94 5.70
DISTANZE PROGRESSIVE [m]	0.00	1.79	4.93	5.70	5.70	6.37		12.16		16.67	17.99	21.28	25.80	28.59		34.60 35.02
DISTANZE PARZIALI [m]		1.79	3.14					5.79		4.51	1.32	3.29	4.52	2.79		6.01

Torrente Parmignola  
SEZIONE N° 00117\_\_13

LEGENDA:

TR30 H = 5.19 m. s.l.m. ———

TR200 H = 5.24 m. s.l.m. ———

TR500 H = 5.26 m. s.l.m. - - - - -

SCALA DISTANZE 1:200  
SCALA QUOTE 1:200

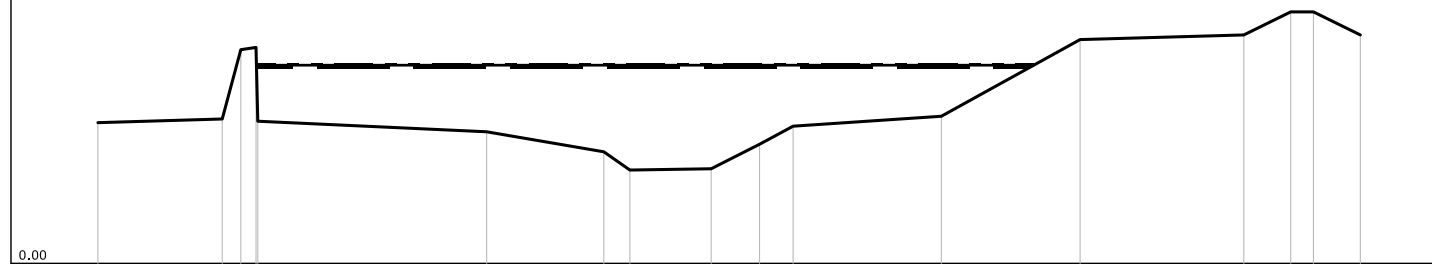

PUNTI	1	2	3	4	6	7	8	9	10	11	12	13	14	15	16	17
QUOTE [m s.l.m.]	3.72	3.82	5.65	5.71	3.48	2.95	2.47	2.50	3.15	3.63	3.89	5.92	6.04	6.65	6.65	6.04
DISTANZE PROGRESSIVE [m]	0.00	3.29	3.78	4.18	10.28	13.38	14.07	16.22	17.50	18.39	22.31	25.98	30.31	31.55	32.15	33.39
DISTANZE PARZIALI [m]		3.29			6.05	3.10	2.15	1.28	3.92	3.67	4.33	1.24	1.24			

Torrente Parmignola  
 SEZIONE N° 00113\_\_13

LEGENDA:

TR30 H = 5.09 m. s.l.m. ———

TR200 H = 5.12 m. s.l.m. ———

TR500 H = 5.14 m. s.l.m. - - - - -

SCALA DISTANZE 1:200  
 SCALA QUOTE 1:200

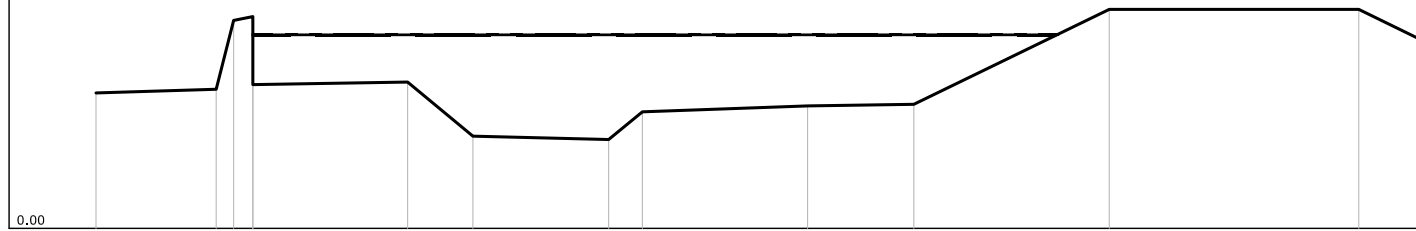

PUNTI	1	2	3	4	6	7	8	9	10	11	12	13	14
QUOTE [m s.l.m.]	3.58	3.68	5.50	5.60	3.87	2.44	2.35	3.08	3.24	3.28	5.79	5.79	5.00
DISTANZE PROGRESSIVE [m]	0.00	3.18	3.64	4.15	8.24	9.97	13.56	14.45	18.82	21.63	26.80	33.40	35.02
DISTANZE PARZIALI [m]		3.18			4.09	1.73	3.59		4.37	2.81	5.17	6.60	1.62

Torrente Parmignola  
SEZIONE N° 00110\_\_13

LEGENDA:

TR30 H =4.99 m. s.l.m. \_\_\_\_\_

TR200 H =5.01 m. s.l.m. \_\_\_\_\_

TR500 H =5.03 m. s.l.m. - - - - -

SCALA DISTANZE 1:200  
SCALA QUOTE 1:200

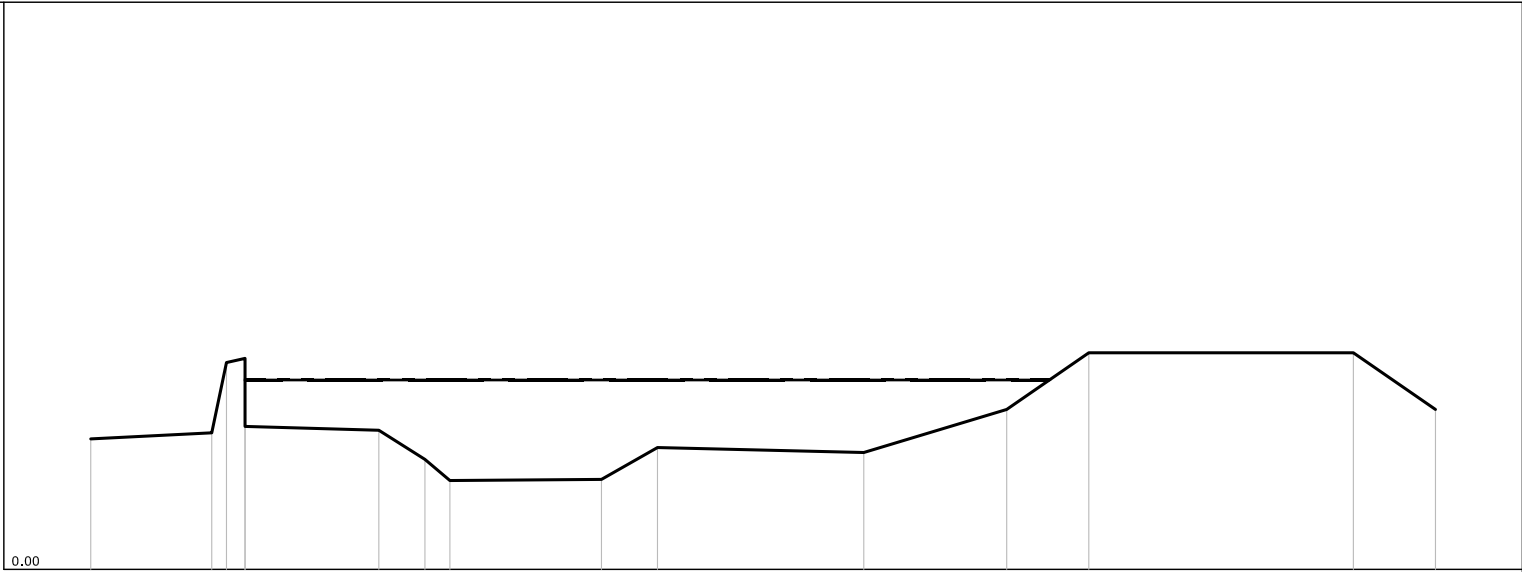

PUNTI	1	2	3	4	6	7	8	9	10	11	12	13	14	15
QUOTE [m s.l.m.]	3.45	3.61	5.47	5.38	3.68	2.91	2.35	2.38	3.22	3.09	4.23	5.73	5.73	4.23
DISTANZE PROGRESSIVE [m]	0.00	3.20	3.59	4.08	7.62	8.84	9.50	13.51	14.99	20.45	24.23	26.40	33.40	35.57
DISTANZE PARZIALI [m]		3.20		3.54	1.22		4.01	1.48	5.46	3.78	2.17	7.00	2.17	

Torrente Parmignola  
SEZIONE N° 00107\_\_13

LEGENDA:

TR30 H =4.86 m. s.l.m. ———

TR200 H =4.88 m. s.l.m. ———

TR500 H =4.90 m. s.l.m. - - - - -

SCALA DISTANZE 1:200  
SCALA QUOTE 1:200

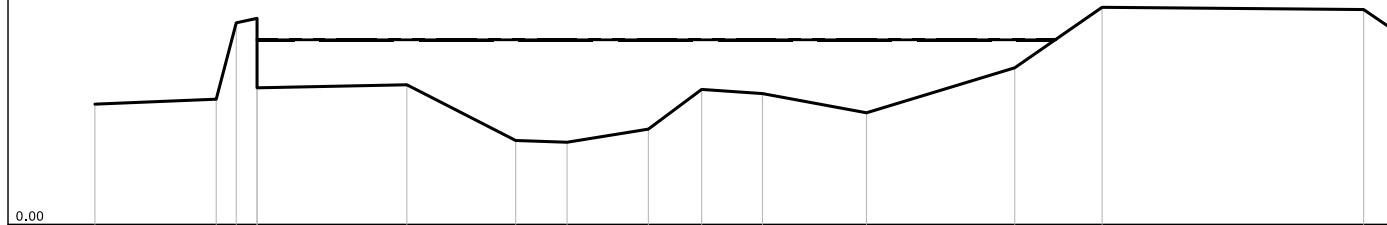

PUNTI	1	2	3	4	6	7	8	9	10	11	12	13	14	15	16
QUOTE [m s.l.m.]	3.18	3.31	5.33	5.45	3.69	2.22	2.17	2.52	3.57	3.46	2.95	4.14	5.74	5.68	5.18
DISTANZE PROGRESSIVE [m]	0.00	3.21	3.74	4.29	8.25	11.13	12.49	14.64	16.05	17.66	20.41	24.33	26.64	33.56	34.29
DISTANZE PARZIALI [m]		3.21			3.96	2.88	1.36	2.15	1.41	1.61	2.75	3.92	2.31	6.92	

Torrente Parmignola  
SEZIONE N° 00104\_\_13

LEGENDA:

TR30 H =4.74 m. s.l.m. ————

TR200 H =4.76 m. s.l.m. ————

TR500 H =4.77 m. s.l.m. - - - - -

SCALA DISTANZE 1:200  
SCALA QUOTE 1:200

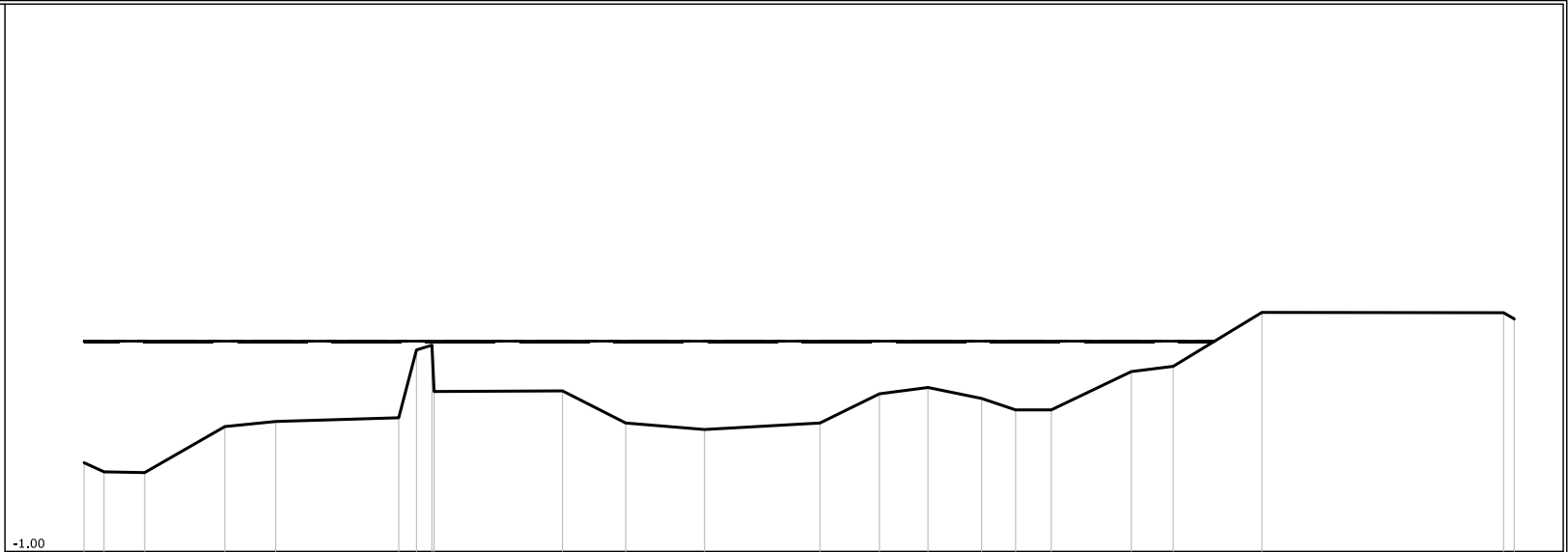

PUNTI	2	3	4	5	6	7	8	9	11	12	13	14	15	16	17	18	19	20	21	22	23	24
QUOTE [m s.l.m.]	1.43	1.18	1.16	2.42	2.56	2.66	4.52	4.65	3.40	2.52	2.34	2.52	3.32	3.49	3.19	2.88	2.88	3.93	4.07	5.55	5.54	5.37
DISTANZE PROGRESSIVE [m]	6.89	7.44	8.55	10.75	12.14	15.51	16.00	16.42	20.00	21.73	23.89	27.05	28.68	30.01	31.48	32.41	33.39	35.58	36.73	39.16	45.78	46.07
DISTANZE PARZIALI [m]		1.11	2.20	1.39	3.37				3.52	1.73	2.16	3.16	1.63	1.33	1.47	0.98	2.19	1.15	2.43	6.62		

Torrente Parmignola  
SEZIONE N° 00101\_\_13

LEGENDA:

TR30 H =4.66 m. s.l.m. ———

TR200 H =4.67 m. s.l.m. ———

TR500 H =4.68 m. s.l.m. - - - - -

SCALA DISTANZE 1:200  
SCALA QUOTE 1:200

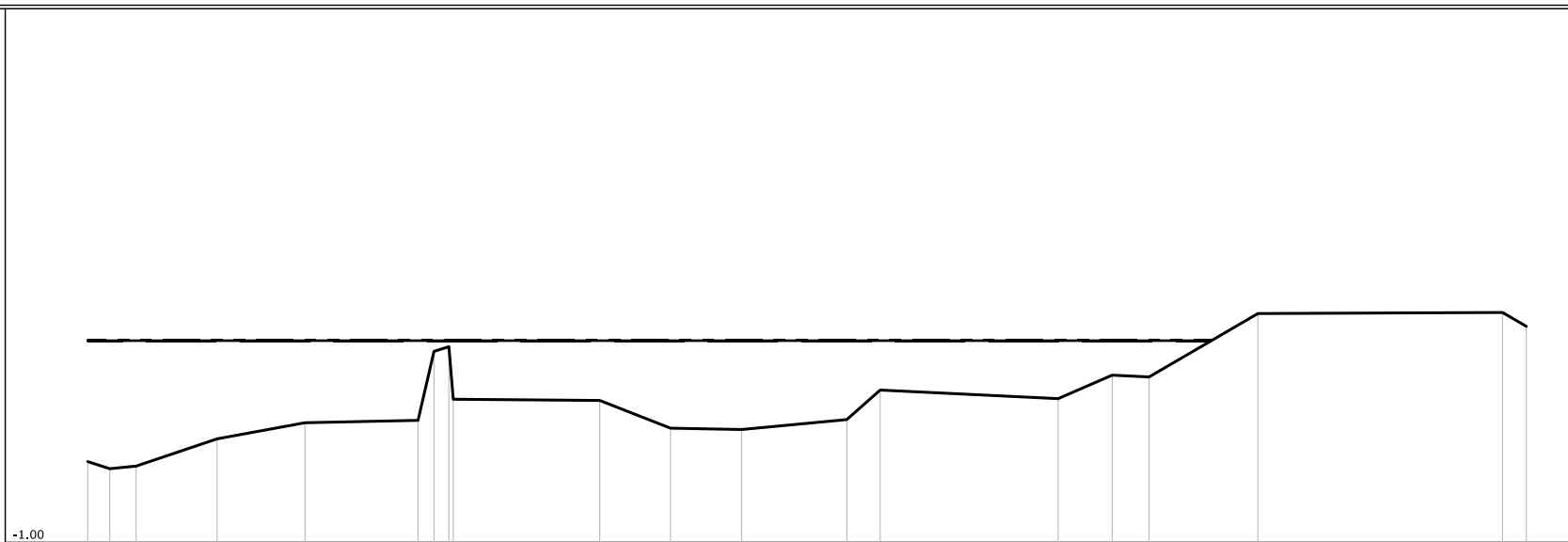

PUNTI	2	3	4	5	6	7	8	9	11	12	13	14	15	16	17	18	19	20	21
QUOTE [m s.l.m.]	1.27	1.07	1.14	1.91	2.36	2.43	4.37	4.50	2.99	2.21	2.17	2.45	3.28	3.04	3.70	3.65	5.43	5.46	5.07
DISTANZE PROGRESSIVE [m]	4.71	5.33	6.07	8.35	10.82	14.00	14.45	14.87	19.11	21.10	23.10	26.06	27.00	32.00	33.52	34.56	37.62	44.50	45.17
DISTANZE PARZIALI [m]			2.28	2.47	3.18				4.12	1.99	2.00	2.96		5.00	1.52	1.04	3.06	6.88	

Torrente Parmignola  
 SEZIONE N° 00098\_\_13

LEGENDA:

TR30 H =4.56 m. s.l.m. ————

TR200 H =4.58 m. s.l.m. ————

TR500 H =4.59 m. s.l.m. - - - - -

SCALA DISTANZE 1:200  
 SCALA QUOTE 1:200

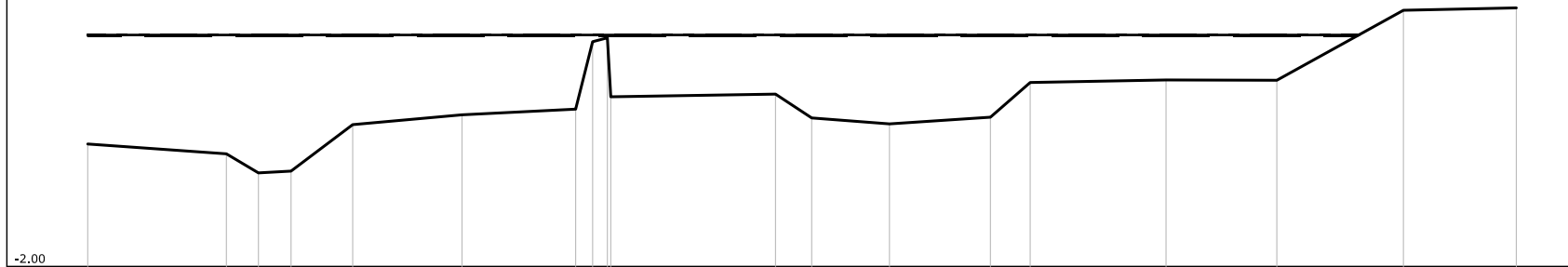

PUNTI	1	2	3	4	5	6	7	8	9	11	12	13	14	15	16	17	18	19
QUOTE [m s.l.m.]	1.48	1.20	0.66	0.71	2.03	2.31	2.47	4.39	4.50	2.90	2.22	2.05	2.24	3.23	3.30	3.29	5.28	5.35
DISTANZE PROGRESSIVE [m]	0.00	3.94	4.85	5.78	7.53	10.64	13.87	14.35	14.77	19.55	20.58	22.79	25.66	26.79	30.65	33.80	37.40	40.61
DISTANZE PARZIALI [m]		3.94		1.75	3.11	3.23				4.68	1.03	2.21	2.87	1.13	3.86	3.15	3.60	3.21



Torrente Parmignola  
SEZIONE N° 00095\_\_13

LEGENDA:

TR30 H =4.49 m. s.l.m. ———

TR200 H =4.50 m. s.l.m. ———

TR500 H =4.52 m. s.l.m. - - - - -

SCALA DISTANZE 1:200  
SCALA QUOTE 1:200

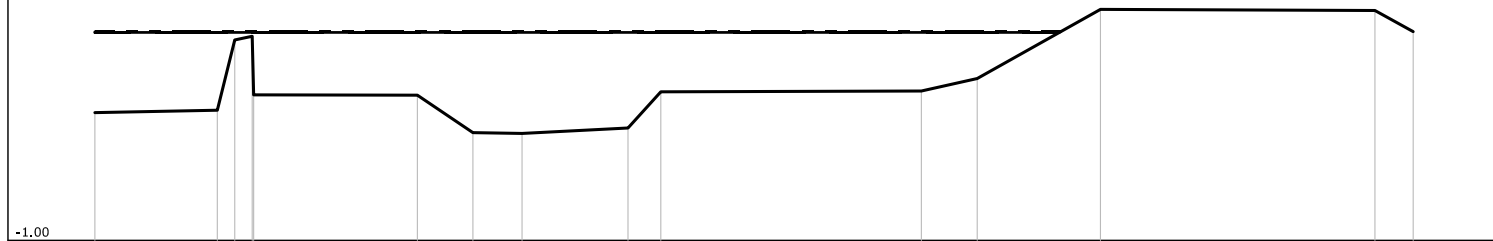

PUNTI	1	2	3	4	6	7	8	9	10	11	12	13	14	15
QUOTE [m s.l.m.]	2.38	2.44	4.30	4.40	2.84	1.85	1.83	1.97	2.93	2.95	3.28	5.11	5.08	4.52
DISTANZE PROGRESSIVE [m]	0.00	3.24	3.70	4.16	8.53	10.00	11.30	14.10	14.97	21.86	23.34	26.60	33.86	34.87
DISTANZE PARZIALI [m]		3.24			4.33	1.47	1.30	2.80		6.89	1.48	3.26	7.26	1.01

Torrente Parmignola  
 SEZIONE N° 00091\_13

LEGENDA:

TR30 H = 4.39 m. s.l.m. ———

TR200 H = 4.41 m. s.l.m. ———

TR500 H = 4.43 m. s.l.m. - - - - -

SCALA DISTANZE 1:200  
 SCALA QUOTE 1:200

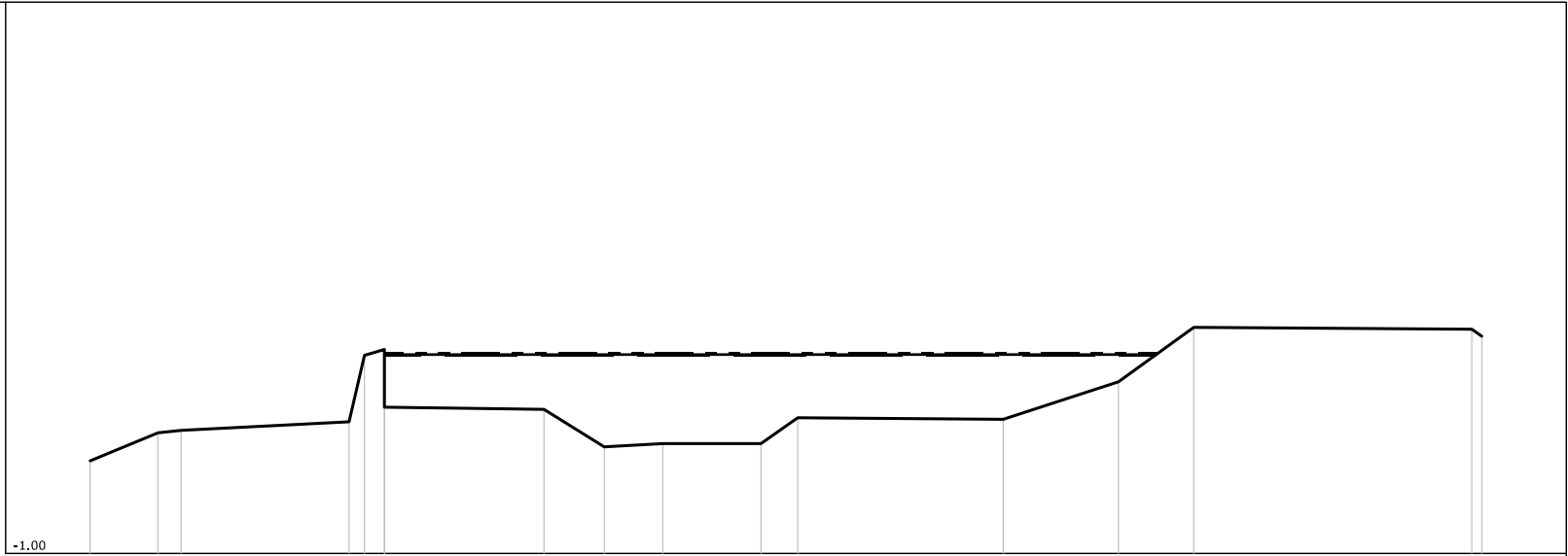

PUNTI	1	2	3	4	5	6	8	9	10	11	12	13	14	15	16	17
QUOTE [m s.l.m.]	1.52	2.28	2.35	2.58	4.39	4.55	2.92	1.90	1.99	1.99	2.69	2.65	3.67	5.15	5.10	4.91
DISTANZE PROGRESSIVE [m]	0.00	1.84	2.47	7.04	7.46	8.00	12.34	13.98	15.57	18.24	19.24	24.83	27.96	30.01	37.87	37.84
DISTANZE PARZIALI [m]		1.84		4.57			4.34	1.64	1.59	2.67	1.00	5.59	3.13	2.05	7.56	

Torrente Parmignola  
SEZIONE N° 00088\_\_13

LEGENDA:

TR30 H =4.29 m. s.l.m. \_\_\_\_\_

TR200 H =4.31 m. s.l.m. \_\_\_\_\_

TR500 H =4.32 m. s.l.m. - - - - -

SCALA DISTANZE 1:200  
SCALA QUOTE 1:200

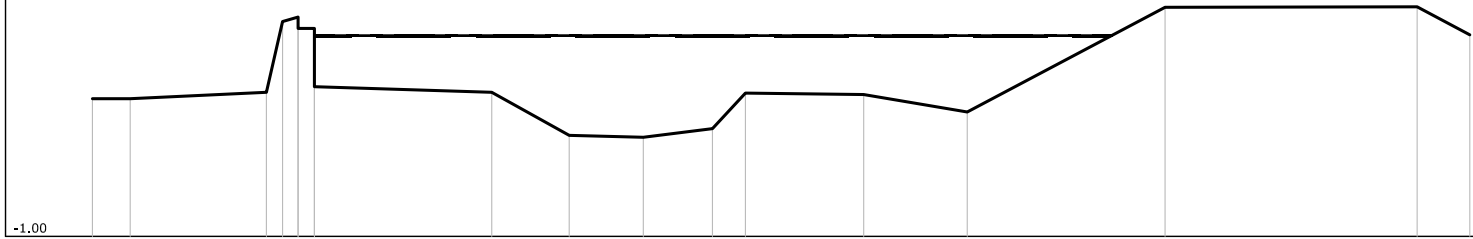

PUNTI	1	2	3	4	5	7	9	10	11	12	13	14	15	16	17	18
QUOTE [m s.l.m.]	2.64	2.64	2.81	4.68	4.80	4.50	2.81	1.67	1.62	1.85	2.79	2.75	2.29	5.06	5.07	4.33
DISTANZE PROGRESSIVE [m]	0.00	1.00	4.60	5.03	5.44	5.87	10.56	12.61	14.57	16.40	17.27	20.40	23.14	28.37	35.04	36.43
DISTANZE PARZIALI [m]	1.00	3.60					4.69	2.05	1.96	1.83		3.13	2.74	5.23	6.67	1.39

Torrente Parmignola  
 SEZIONE N° 00085\_\_13

LEGENDA:

TR30 H =4.22 m. s.l.m. ————

TR200 H =4.24 m. s.l.m. ————

TR500 H =4.25 m. s.l.m. - - - - -

SCALA DISTANZE 1:200  
 SCALA QUOTE 1:200

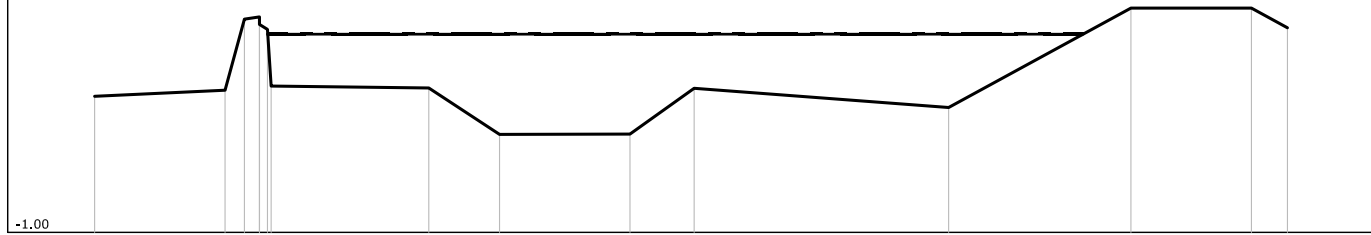



PUNTI	1	2	3	4	7	8	9	10	11	12	13	14	15
QUOTE [m s.l.m.]	2.60	2.76	4.64	4.70	2.87	2.82	1.59	1.60	2.81	2.30	4.93	4.93	4.41
DISTANZE PROGRESSIVE [m]	0.00	3.45	3.96	4.36	4.67	8.84	10.71	14.16	15.86	22.59	27.41	30.60	31.55
DISTANZE PARZIALI [m]		3.45				4.17	1.87	3.45	1.70	6.73	4.82	3.19	

Torrente Parmignola  
SEZIONE N° 00082\_\_13

LEGENDA:

TR30 H = 4.13 m. s.l.m. 

TR200 H = 4.15 m. s.l.m. 

TR500 H = 4.16 m. s.l.m. 

SCALA DISTANZE 1:200  
SCALA QUOTE 1:200

-1.00

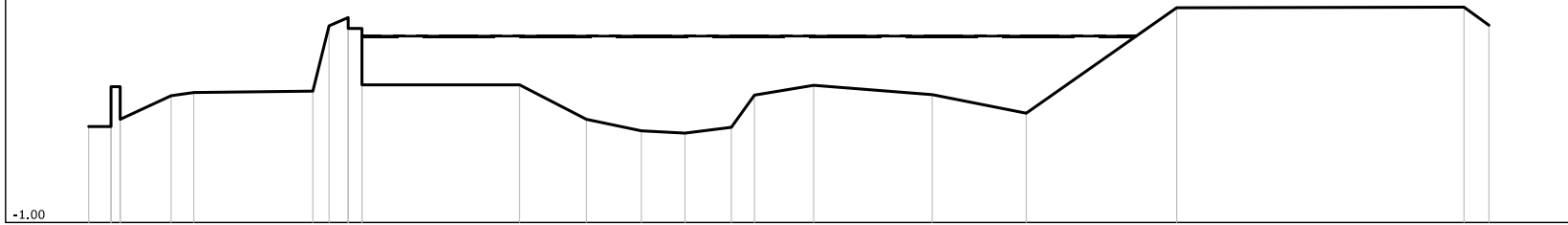

PUNTI	1	24	6	7	8	9	10	12	14	15	16	17	18	19	20	21	22	23	24	25	
QUOTE [m s.l.m.]	1.65	1.95	2.50	2.59	2.63	4.43	4.66	4.36	2.80	1.85	1.53	1.47	1.63	2.52	2.79	2.53	2.02	4.93	4.95	4.45	
DISTANZE PROGRESSIVE [m]	0.00	0.87	2.28	2.91	6.20	6.65	7.18	7.56	11.92	13.77	15.29	16.50	17.78	18.42	20.06	23.34	25.94	30.10	36.05	38.74	
DISTANZE PARZIALI [m]		0.87	1.41		3.29				4.36	1.85	1.52	1.21	1.28		1.64	3.28	2.60	4.16		7.95	

Torrente Parmignola  
SEZIONE N° 00079\_\_13

LEGENDA:

TR30 H =4.03 m. s.l.m. ———

TR200 H =4.05 m. s.l.m. ———

TR500 H =4.06 m. s.l.m. - - - - -

SCALA DISTANZE 1:200  
SCALA QUOTE 1:200

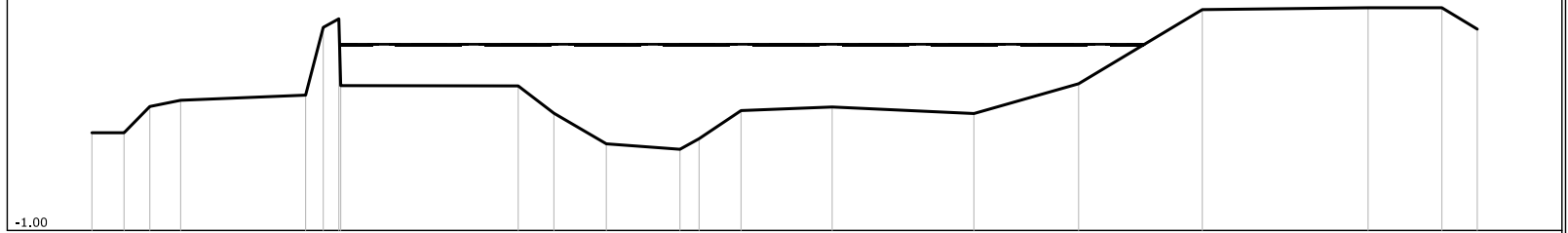

PUNTI	1	2	3	4	5	6	7	9	10	11	12	13	14	15	16	17	18	19	20	21
QUOTE [m s.l.m.]	1.65	1.65	2.36	2.53	2.67	4.51	4.74	2.92	2.18	1.35	1.20	1.49	2.25	2.35	2.17	2.98	4.99	5.04	5.04	4.46
DISTANZE PROGRESSIVE [m]	0.00	0.87	1.57	2.41	5.80	6.28	6.70	11.57	12.54	13.96	15.96	16.48	17.62	20.09	23.94	26.78	30.14	34.64	36.64	37.60
DISTANZE PARZIALI [m]					3.39			4.82	0.97	1.42	2.00	1.14	2.47	3.85	2.84	3.36	4.50	2.00		

Torrente Parmignola  
SEZIONE N° 00076\_\_13

LEGENDA:

TR30 H = 3.92 m. s.l.m. \_\_\_\_\_

TR200 H = 3.94 m. s.l.m. \_\_\_\_\_

TR500 H = 3.95 m. s.l.m. - - - - -

SCALA DISTANZE 1:200  
SCALA QUOTE 1:200

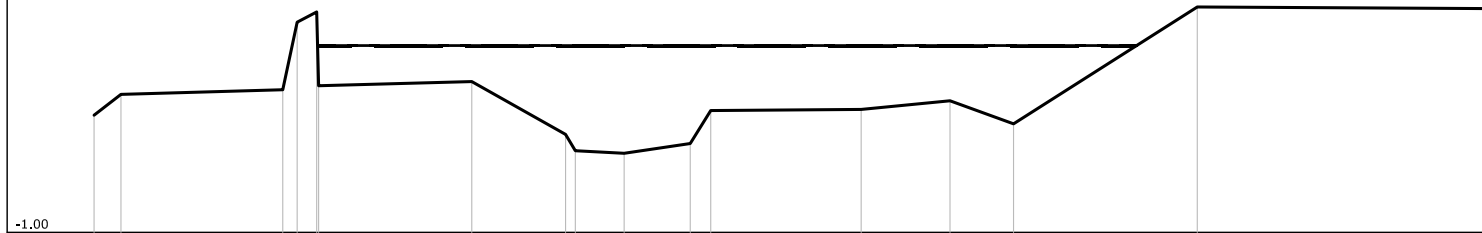

PUNTI	1	2	3	4	5	7	8	9	10	11	12	13	14	15	16	17
QUOTE [m s.l.m.]	2.10	2.65	2.77	4.56	4.83	2.99	1.58	1.16	1.09	1.35	2.22	2.25	2.48	1.87	4.96	4.92
DISTANZE PROGRESSIVE [m]	0.00	0.71	4.99	5.37	5.89	9.99	12.47	12.73	14.02	15.77	16.31	20.29	22.64	24.32	29.18	36.82
DISTANZE PARZIALI [m]			4.28			4.05	2.48	1.29	1.75		3.98	2.35	1.68	4.86	7.64	

Torrente Parmignola  
SEZIONE N° 00073\_\_13

LEGENDA:

- TR30 H = 3.83 m. s.l.m.
- TR200 H = 3.85 m. s.l.m.
- TR500 H = 3.87 m. s.l.m.

SCALA DISTANZE 1:200  
SCALA QUOTE 1:200

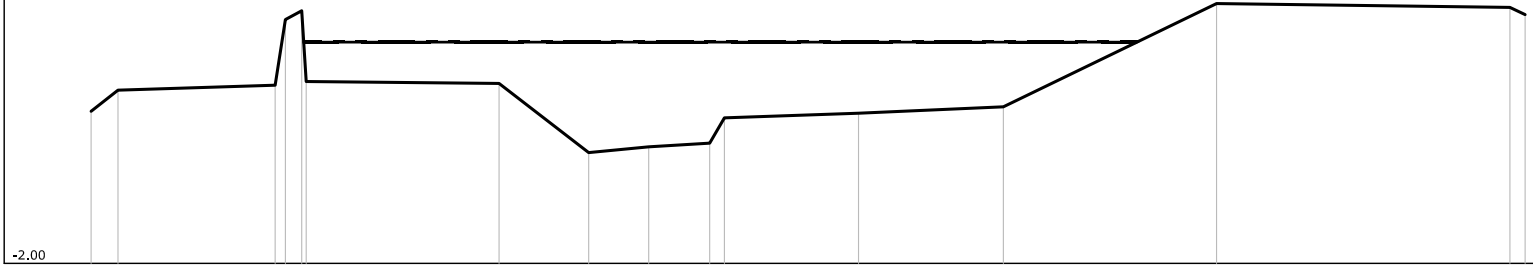

PUNTI	1	2	3	4	5	7	8	9	10	11	12	13	14	15	16
QUOTE [m s.l.m.]	2.02	2.58	2.71	2.74	4.68	2.76	0.93	1.08	1.18	1.85	1.97	2.14	4.87	4.77	4.58
DISTANZE PROGRESSIVE [m]	0.00	0.71	4.87	5.57	5.57	10.79	13.16	14.75	16.36	16.75	20.30	24.13	29.77	37.53	37.93
DISTANZE PARZIALI [m]			4.16			5.10	2.37	1.59	1.61		3.55	3.83	5.64		7.76



Torrente Parmignola  
SEZIONE N° 00070\_\_13

LEGENDA:

- TR30 H = 3.73 m. s.l.m.
- TR200 H = 3.75 m. s.l.m.
- TR500 H = 3.77 m. s.l.m.

SCALA DISTANZE 1:200  
SCALA QUOTE 1:200

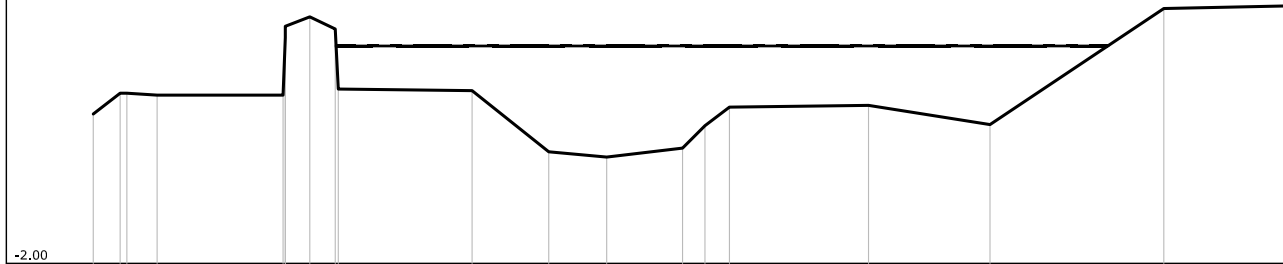

PUNTI	1	2	4	5	8	9	11	12	13	14	15	16	17	18	19	20
QUOTE [m s.l.m.]	1.95	2.50	2.45	2.45	4.52	4.20	2.57	0.95	0.81	1.05	1.64	2.13	2.18	1.67	4.74	4.81
DISTANZE PROGRESSIVE [m]	0.00	0.71	1.69	5.02	5.73	6.40	10.02	12.05	13.58	15.59	16.18	16.83	20.51	23.72	28.32	31.73
DISTANZE PARZIALI [m]				3.33			3.54	2.03	1.53	2.01			3.68	3.21	4.60	3.41

Torrente Parmignola  
SEZIONE N° 00067\_\_13

LEGENDA:

TR30 H =3.64 m. s.l.m. ———

TR200 H =3.66 m. s.l.m. ———

TR500 H =3.68 m. s.l.m. - - - - -

SCALA DISTANZE 1:200  
SCALA QUOTE 1:200

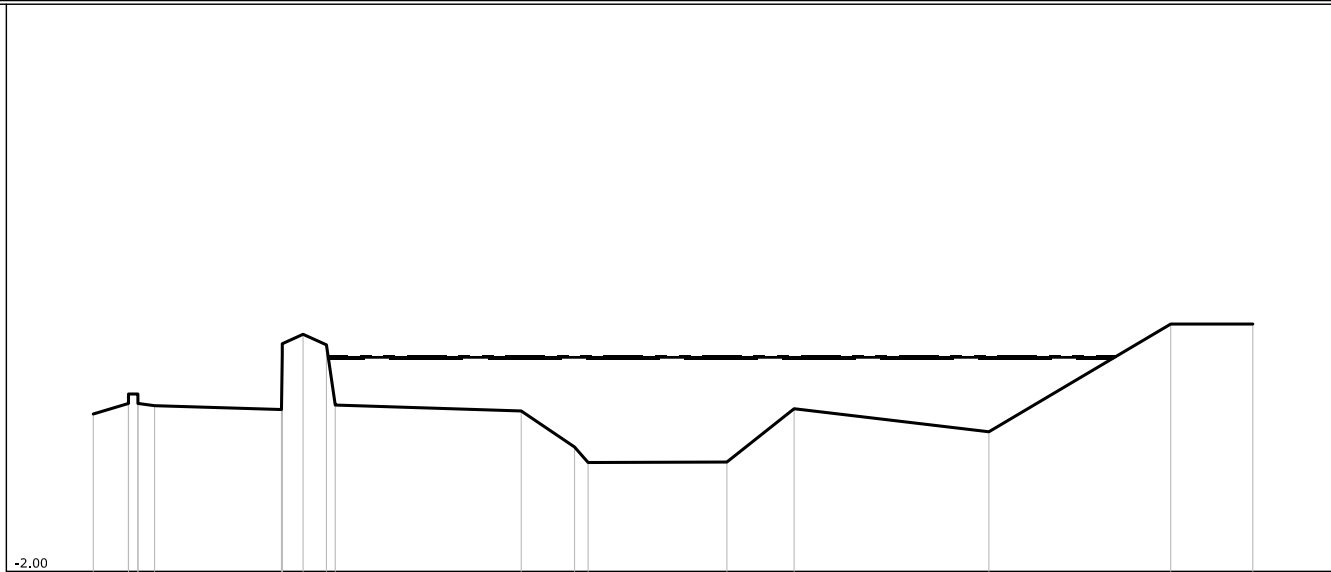



PUNTI	1	2	3	4	5	6	7	8	9	10	11	12	13	14	15	16	17	18	19	20			
QUOTE [m s.l.m.]	2.16	2.44	2.89	2.38			2.28	4.27	3.99			2.24	1.29	0.88		0.89	2.30		1.69		4.54	4.54	
DISTANZE PROGRESSIVE [m]	0.00	0.88	1.18	1.62			4.98	5.85	6.17			11.32	12.73	13.09		16.76	18.54		23.69		28.50	30.67	
DISTANZE PARZIALI [m]				3.36						4.92			1.41		3.67	1.78		5.15		4.81		2.17	

Torrente Parmignola  
SEZIONE N° 00065\_\_13

LEGENDA:

TR30 H =3.55 m. s.l.m. 

TR200 H =3.57 m. s.l.m. 

TR500 H =3.59 m. s.l.m. 

SCALA DISTANZE 1:200  
SCALA QUOTE 1:200

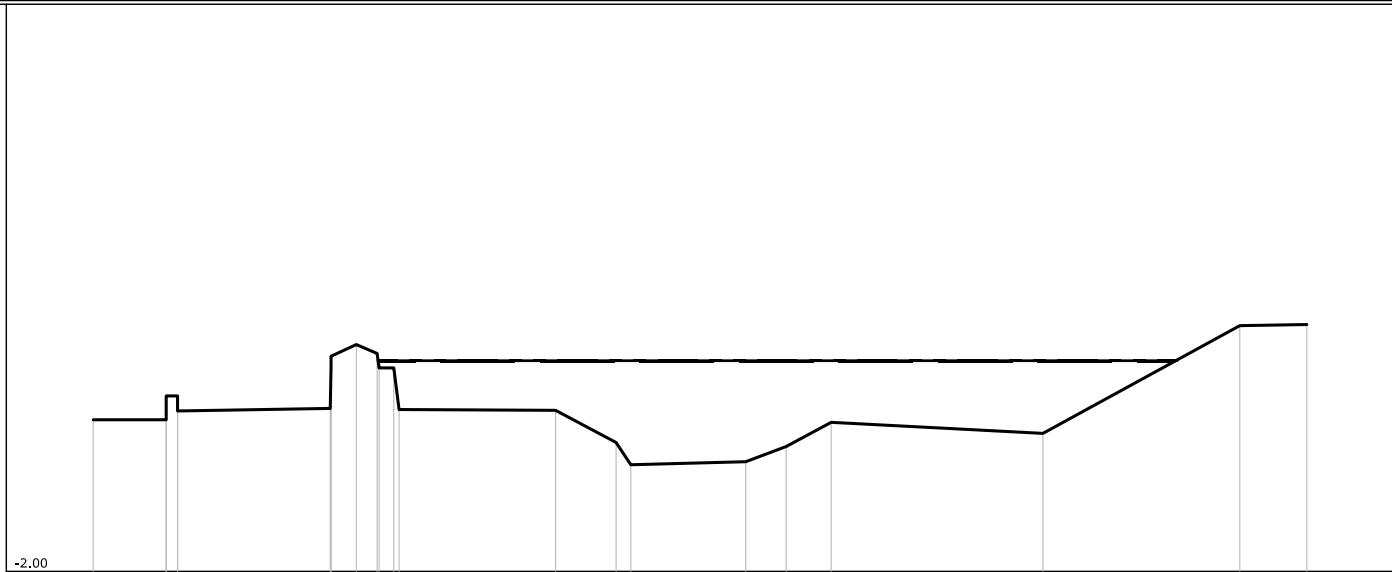

PUNTI	1	2	4	6	9	10	12	14	15	16	17	18	19	20	21	22
QUOTE [m s.l.m.]	2.01	2.01	2.04	2.31	4.00	3.76	3.38	2.26	1.41	0.82	0.90	1.30	1.94	1.65	4.50	4.53
DISTANZE PROGRESSIVE [m]	0.00	1.93	2.93	6.27	6.96	7.51	7.95	12.23	13.83	14.22	17.26	18.33	19.52	25.12	30.33	32.10
DISTANZE PARZIALI [m]		1.93		4.04				4.14	1.60	3.04	1.07	1.19		5.60	5.21	1.77

Torrente Parmignola  
 SEZIONE N° 00062\_\_13

LEGENDA:

- TR30 H =3.47 m. s.l.m.
- TR200 H =3.50 m. s.l.m.
- TR500 H =3.51 m. s.l.m.

SCALA DISTANZE 1:200  
 SCALA QUOTE 1:200

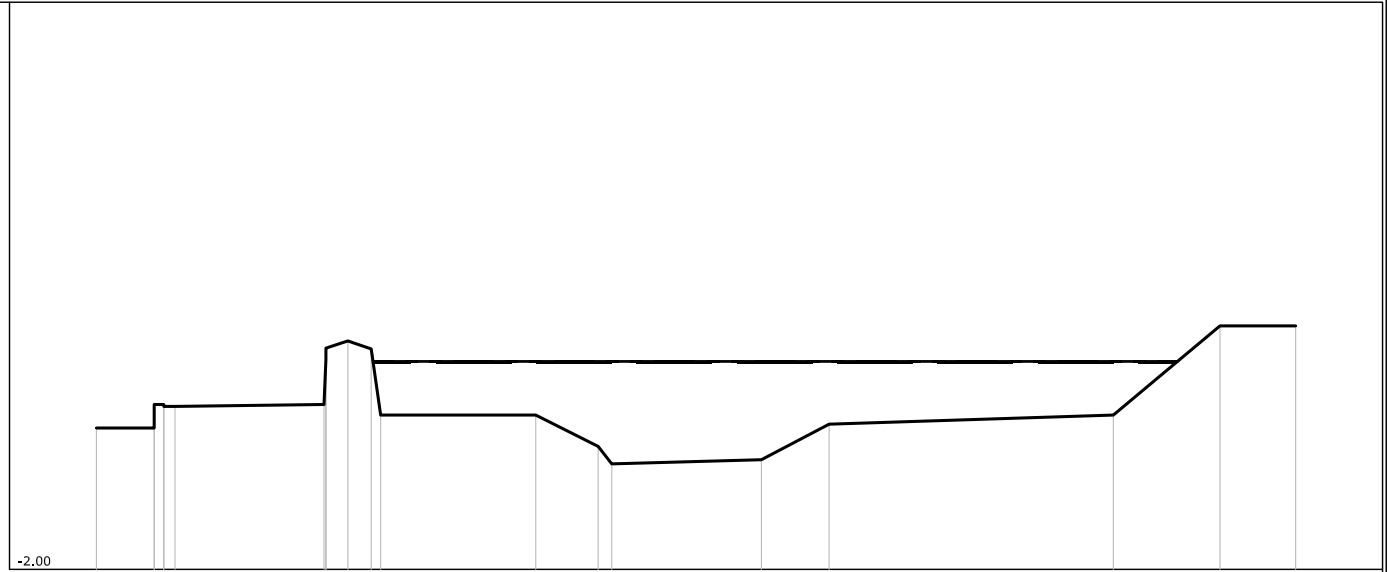



PUNTI	1	24	6	7	10	112	13	1415	16	17	18	19	20			
QUOTE [m s.l.m.]	1.74	1.74	2.36	2.36	2.31	2.36	2.36	2.31	2.36	2.31	2.08	4.44	4.44			
DISTANZE PROGRESSIVE [m]	0.00	1.53	1.78	2.36	2.31	6.02	6.65	7.82	11.62	13.27	13.63	17.59	19.38	26.90	29.72	31.72
DISTANZE PARZIALI [m]		1.53		3.94			4.10	1.65	3.96	1.79	7.52	2.82	2.00			

Torrente Parmignola  
 SEZIONE N° 00059\_\_13

LEGENDA:

TR30 H = 3.39 m. s.l.m. 

TR200 H = 3.41 m. s.l.m. 

TR500 H = 3.43 m. s.l.m. 

SCALA DISTANZE 1:200  
 SCALA QUOTE 1:200

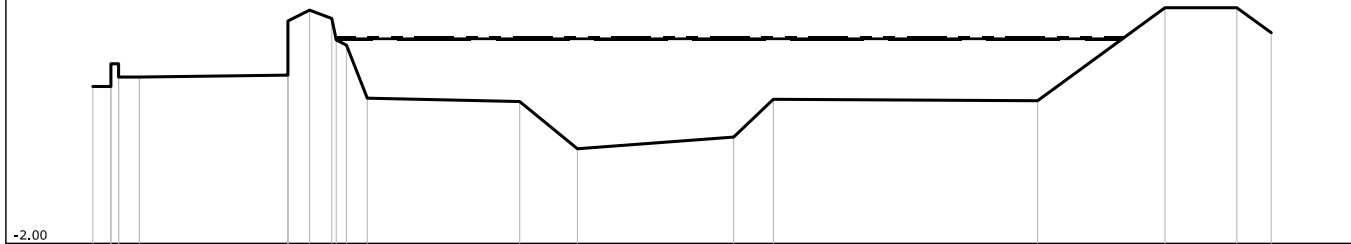



PUNTI	1	2	6	7	10	11	13	14	15	16	17	18	19	20	21	22
QUOTE [m s.l.m.]	2.15	2.15	2.40	2.45	4.17	3.95	3.24	1.84	1.75	0.50	0.81	1.81	1.77	4.23	4.23	3.57
DISTANZE PROGRESSIVE [m]	0.00	0.48	1.23	5.16	5.73	6.32	6.71	7.26	11.29	12.82	16.95	18.00	24.99	28.36	30.26	31.17
DISTANZE PARZIALI [m]				3.93					4.03	1.53	4.13	1.05	6.99	3.37	1.90	

Torrente Parmignola  
 SEZIONE N° 00058\_\_13

LEGENDA:

TR30 H = 3.33 m. s.l.m. 

TR200 H = 3.35 m. s.l.m. 

TR500 H = 3.37 m. s.l.m. 

SCALA DISTANZE 1:200  
 SCALA QUOTE 1:200

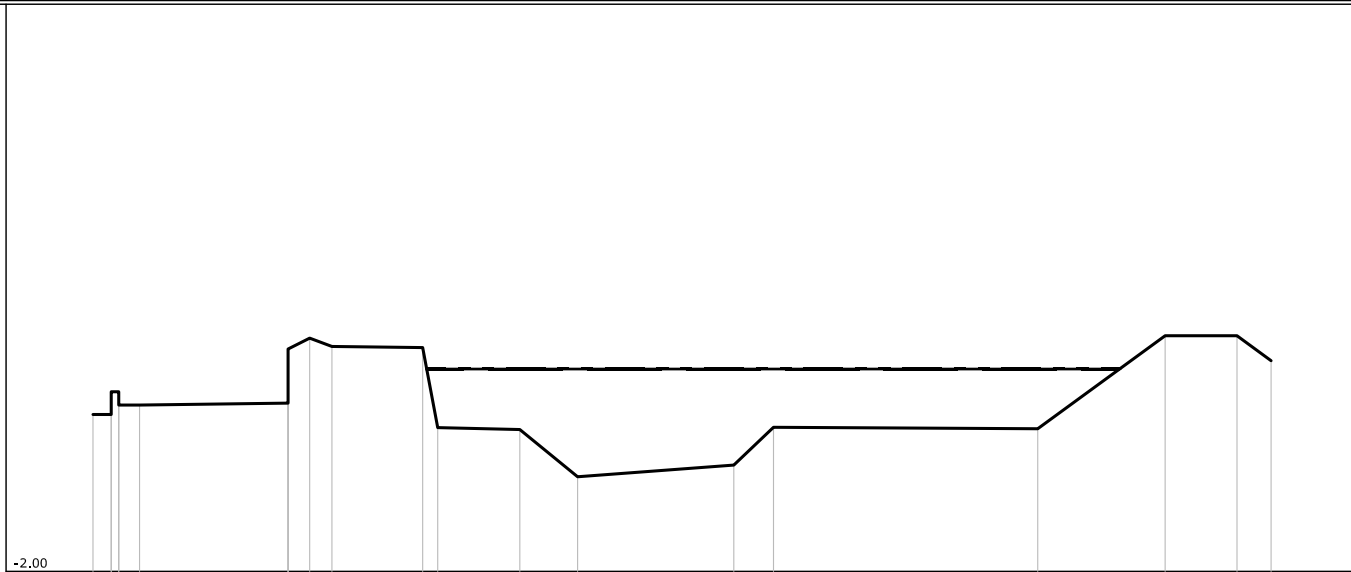

PUNTI	1	2	6	7	10	11	12	13	14	15	16	17	18	19	20	21
QUOTE [m s.l.m.]	2.15	2.15	2.40	2.45	4.17	3.95	3.92	1.80	1.75	0.50	0.81	1.81	1.77	4.23	4.23	3.57
DISTANZE PROGRESSIVE [m]	0.00	0.48	1.23	5.16	5.73	6.32	8.72	9.12	11.29	12.82	16.95	18.00	24.99	28.36	30.26	31.16
DISTANZE PARZIALI [m]				3.93			2.40		2.17	1.53	4.13	1.05	6.99	3.37	1.90	

Torrente Parmignola  
 SEZIONE N° 00057\_\_13

LEGENDA:

TR30 H = 3.28 m. s.l.m. 

TR200 H = 3.30 m. s.l.m. 

TR500 H = 3.31 m. s.l.m. 

SCALA DISTANZE 1:200  
 SCALA QUOTE 1:200

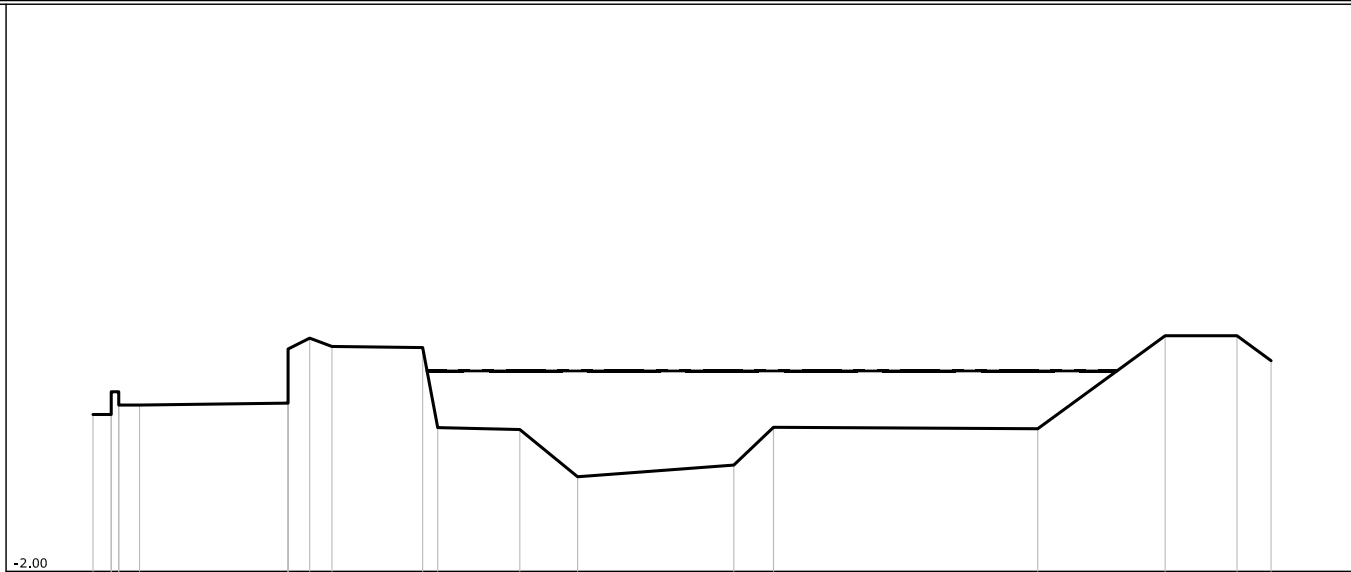

PUNTI	1	2	6	7	10	11	12	13	14	15	16	17	18	19	20	21
QUOTE [m s.l.m.]	2.15	2.15	2.40	2.45	4.17	3.95	3.92	1.80	1.75	0.50	0.81	1.81	1.77	4.23	4.23	3.57
DISTANZE PROGRESSIVE [m]	0.00	0.48	1.23	5.16	5.73	6.32	8.72	9.12	11.29	12.82	16.95	18.00	24.99	28.36	30.26	31.16
DISTANZE PARZIALI [m]				3.93			2.40		2.17	1.53	4.13	1.05	6.99	3.37	1.90	

Torrente Parmignola  
 SEZIONE N° 00055\_\_13

LEGENDA:

TR30 H =3.29 m. s.l.m. ———

TR200 H =3.31 m. s.l.m. ———

TR500 H =3.32 m. s.l.m. - - - - -

SCALA DISTANZE 1:200  
 SCALA QUOTE 1:200

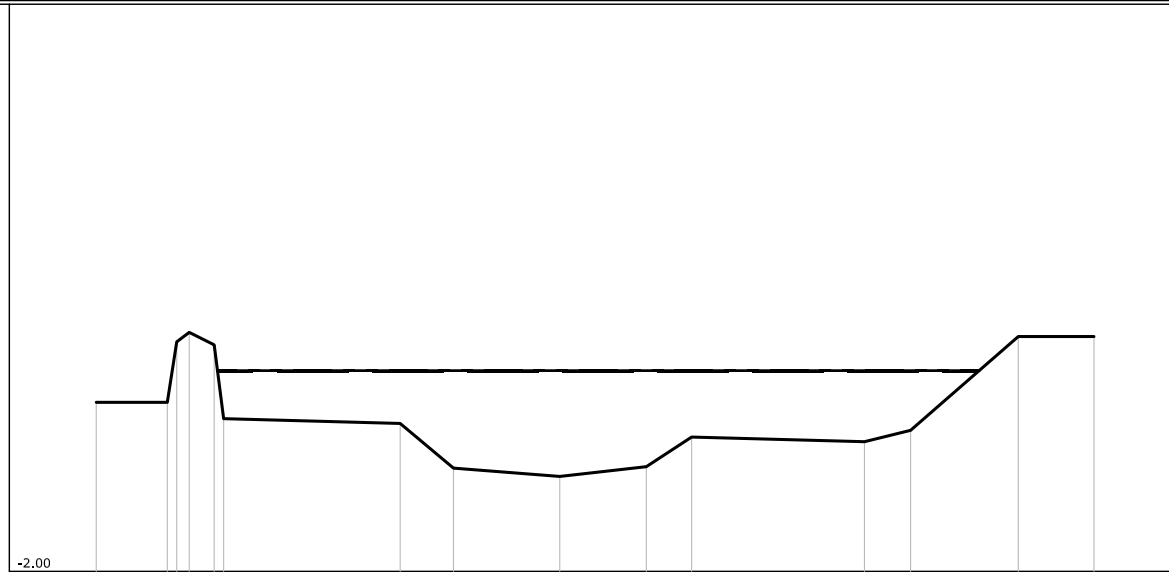

PUNTI	1	2	3	4	5	6	7	8	9	10	11	12	13	14	15
QUOTE [m s.l.m.]	2.47	2.47	4.07	4.32	3.89	3.04	1.91	0.73	0.51	0.77	1.55	1.43	1.73	4.21	4.21
DISTANZE PROGRESSIVE [m]	0.00	1.88	2.13	2.46	3.12	3.37	8.04	9.45	12.26	14.55	15.75	20.32	21.54	24.39	26.39
DISTANZE PARZIALI [m]		1.88					4.67	1.41	2.81	2.29	1.20	4.57	1.22	2.85	2.00



Torrente Parmignola  
 SEZIONE N° 00052\_\_13

LEGENDA:

- TR30 H = 3.19 m. s.l.m.
- TR200 H = 3.21 m. s.l.m.
- TR500 H = 3.22 m. s.l.m.

SCALA DISTANZE 1:200  
 SCALA QUOTE 1:200

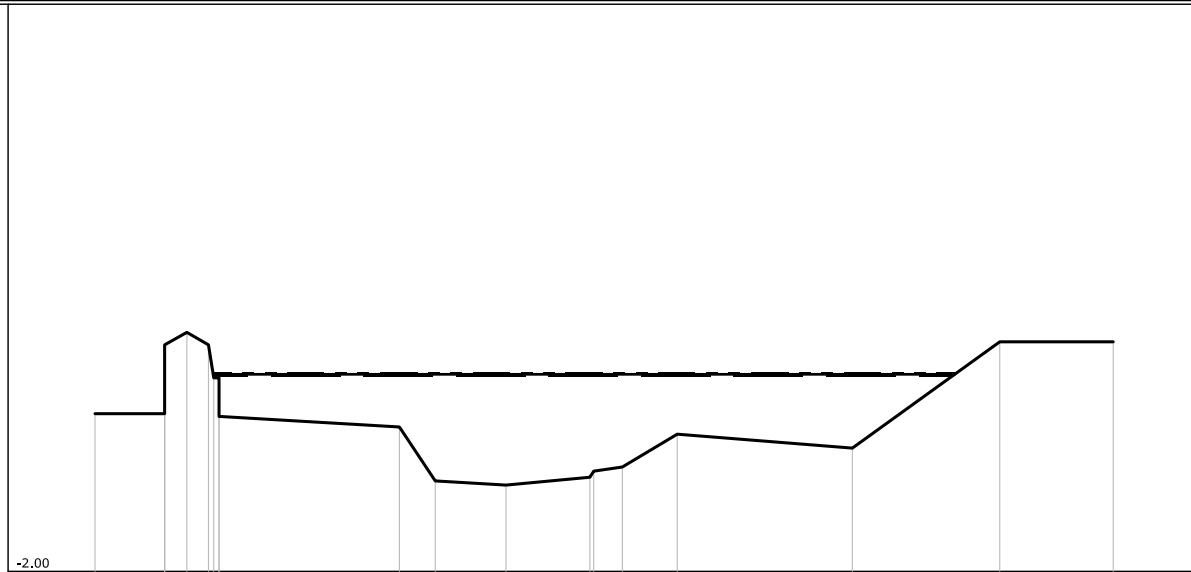

PUNTI	1	2	5	6	8	10	11	12	13	15	16	17	18	19
QUOTE [m s.l.m.]	2.17	2.17	4.32	3.99	3.12	1.82	0.39	0.28	0.49	0.76	1.63	1.26	4.07	4.07
DISTANZE PROGRESSIVE [m]	0.00	1.84	2.43	3.00	3.28	8.05	9.00	10.87	13.09	13.95	15.40	20.03	23.93	26.93
DISTANZE PARZIALI [m]		1.84				4.77		1.87	2.22		1.45	4.63	3.90	3.00

Torrente Parmignola  
SEZIONE N° 00049\_\_13

LEGENDA:

TR30 H = 3.13 m. s.l.m. ———

TR200 H = 3.15 m. s.l.m. ———

TR500 H = 3.16 m. s.l.m. - - - - -

SCALA DISTANZE 1:200  
SCALA QUOTE 1:200



PUNTI	1	2	5	6	8	10	11	12	13	14	15	16	17
QUOTE [m s.l.m.]	2.08	2.08	4.13	3.82	3.12	1.77	0.23	0.28	1.47	1.47	1.30	4.00	4.00
DISTANZE PROGRESSIVE [m]	0.00	1.84	2.42	3.05	3.32	7.78	8.64	13.88	15.59	18.16	20.37	26.11	31.11
DISTANZE PARZIALI [m]		1.84				4.46		5.24	1.71	2.57	2.21	5.74	5.00

Torrente Parmignola  
SEZIONE N° 00046\_\_13

LEGENDA:

TR30 H = 3.08 m. s.l.m. ———

TR200 H = 3.10 m. s.l.m. ———

TR500 H = 3.11 m. s.l.m. - - - - -

SCALA DISTANZE 1:200  
SCALA QUOTE 1:200

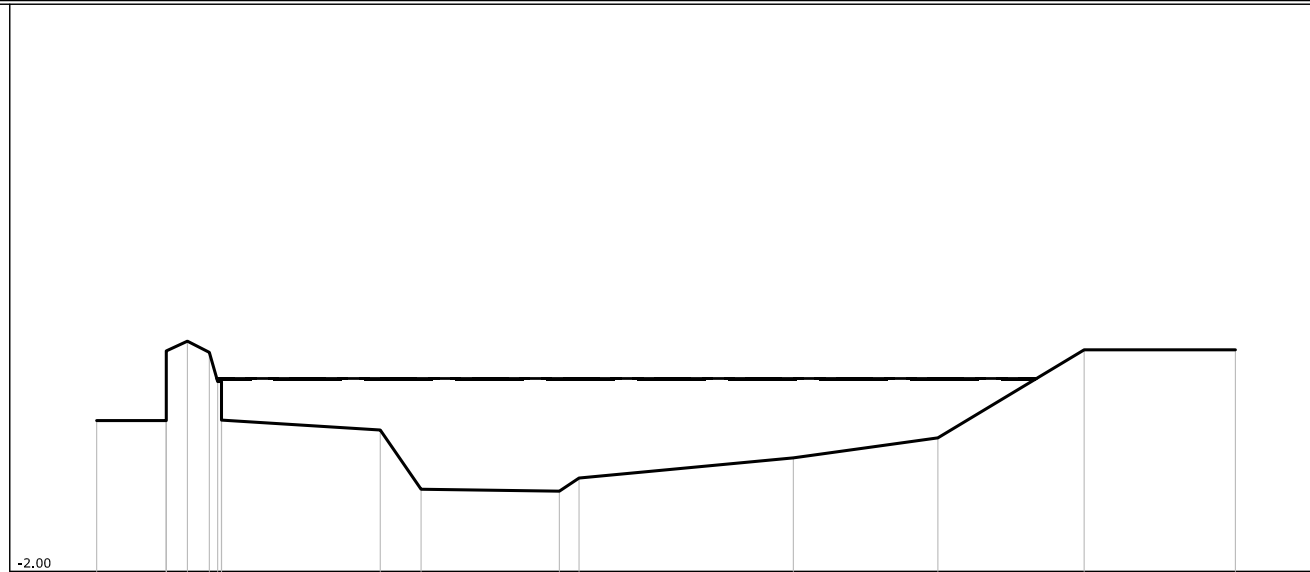

PUNTI	1	2	5	6	8	10	11	12	13	14	15	16	17
QUOTE [m s.l.m.]	1.99	1.99	4.09	3.79	3.02	1.74	0.17	0.12	0.47	1.00	1.53	3.86	3.86
DISTANZE PROGRESSIVE [m]	0.00	1.84	2.40	2.98	3.30	7.50	8.58	12.24	12.76	18.43	22.25	26.12	30.12
DISTANZE PARZIALI [m]		1.84				4.20	1.08	3.66		5.67	3.82	3.87	4.00

Torrente Parmignola  
 SEZIONE N° 00043\_\_13

LEGENDA:

- TR30 H =3.02 m. s.l.m.
- TR200 H =3.03 m. s.l.m.
- TR500 H =3.05 m. s.l.m.

SCALA DISTANZE 1:200  
 SCALA QUOTE 1:200

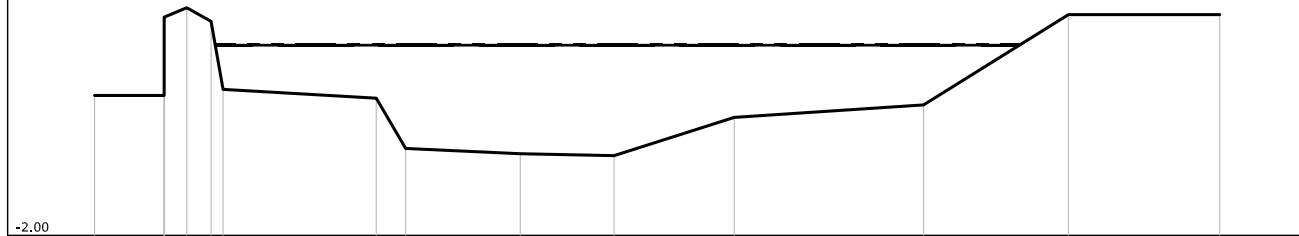

PUNTI	1	2	5	6	7	8	9	10	11	12	13	14	15
QUOTE [m s.l.m.]	1.70	1.70	4.02	3.66	1.86	1.63	0.30	0.16	0.11	1.12	1.45	3.84	3.84
DISTANZE PROGRESSIVE [m]	0.00	1.84	2.44	3.08	3.40	7.45	8.23	11.26	13.74	16.92	21.93	25.76	29.76
DISTANZE PARZIALI [m]		1.84				4.05		3.03	2.48	3.18	5.01	3.83	4.00

Torrente Parmignola  
SEZIONE N° 00040\_\_13

LEGENDA:

- TR30 H =2.97 m. s.l.m.
- TR200 H =2.98 m. s.l.m.
- TR500 H =3.00 m. s.l.m.

SCALA DISTANZE 1:200  
SCALA QUOTE 1:200

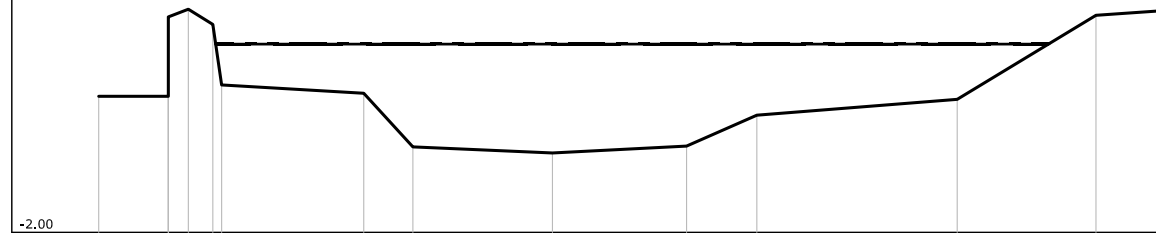

PUNTI	1	2	5	6	8	9	10	11	12	13	14	15
QUOTE [m s.l.m.]	1.60	1.60	3.90	3.50	1.68	0.26	0.10	0.28	1.10	1.52	3.74	3.87
DISTANZE PROGRESSIVE [m]	0.00	1.84	2.37	3.02	7.01	8.31	12.00	15.55	17.41	22.71	26.38	28.27
DISTANZE PARZIALI [m]		1.84			3.76	1.30	3.69	3.55	1.86	5.30	3.67	1.89

Torrente Parmignola  
SEZIONE N° 00037\_\_13

LEGENDA:

TR30 H =2.92 m. s.l.m. ———

TR200 H =2.94 m. s.l.m. ———

TR500 H =2.95 m. s.l.m. - - - - -

SCALA DISTANZE 1:200  
SCALA QUOTE 1:200

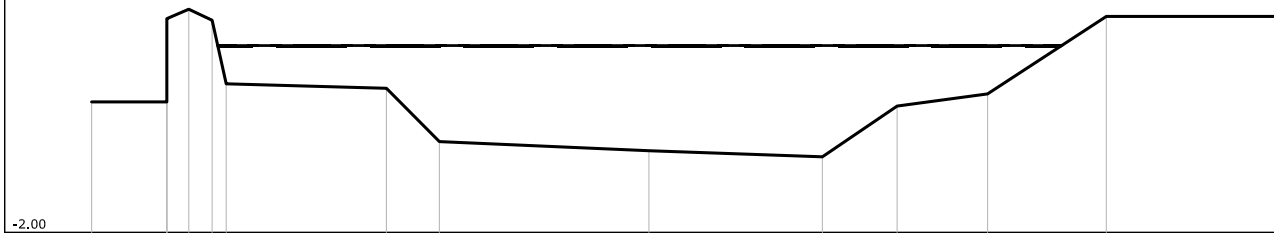

PUNTI	1	2	5	6	7	8	9	10	11	12	13	14	15
QUOTE [m s.l.m.]	1.45	1.45	3.90	3.61	1.93	1.81	0.40	0.16	0.00	1.34	1.66	3.71	3.71
DISTANZE PROGRESSIVE [m]	0.00	1.99	2.57	3.19	3.56	7.80	9.20	14.74	19.33	21.31	23.70	26.84	31.34
DISTANZE PARZIALI [m]		1.99				4.24	1.40	5.54	4.59	1.98	2.39	3.14	4.50

Torrente Parmignola  
SEZIONE N° 00034PA08

LEGENDA:

- TR30 H =2.80 m. s.l.m.
- TR200 H =2.81 m. s.l.m.
- TR500 H =2.82 m. s.l.m.

SCALA DISTANZE 1:200  
SCALA QUOTE 1:200

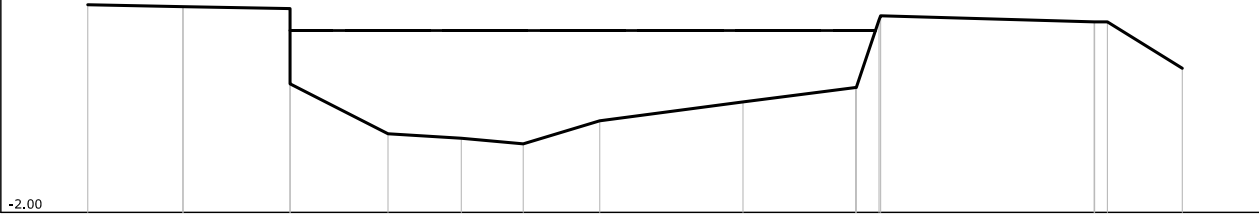

PUNTI	1	2	4	6	7	8	9	10	11	13	15	17	18
QUOTE [m s.l.m.]	3.49	3.44	3.39	0.08	-0.04	-0.19	0.42	0.92	1.30	3.09	3.04	3.04	1.81
DISTANZE PROGRESSIVE [m]	0.00	2.52	5.35	7.94	9.88	11.52	13.54	17.33	20.31	20.93	26.62	26.97	28.95
DISTANZE PARZIALI [m]		2.52	2.83	2.59	1.94	1.64	2.02	3.79	2.98		5.65		1.98

Torrente Parmignola  
SEZIONE N° 00034PB08

LEGENDA:

- TR30 H =2.80 m. s.l.m.
- TR200 H =2.81 m. s.l.m.
- TR500 H =2.82 m. s.l.m.

SCALA DISTANZE 1:200  
SCALA QUOTE 1:200

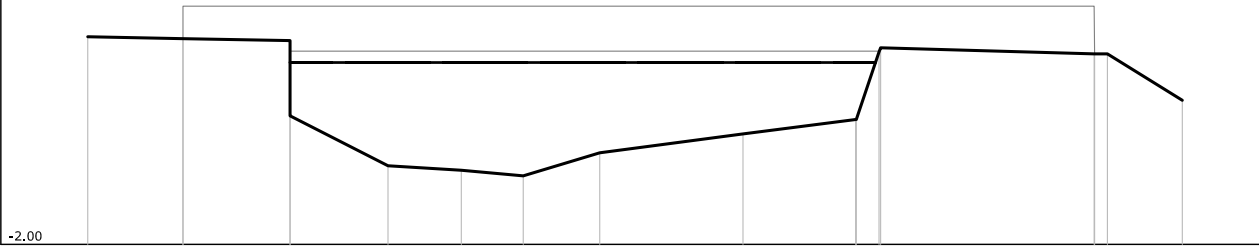

PUNTI	1	2	4	6	7	8	9	10	11	13	15	17	18
QUOTE [m s.l.m.]	3.49	3.44	3.39	0.08	-0.04	-0.19	0.42	0.92	1.30	3.09	3.04	3.04	1.81
DISTANZE PROGRESSIVE [m]	0.00	2.52	5.35	7.94	9.88	11.52	13.54	17.33	20.31	20.93	26.62	26.97	28.95
DISTANZE PARZIALI [m]		2.52	2.83	2.59	1.94	1.64	2.02	3.79	2.98		5.65		1.98



Torrente Parmignola  
SEZIONE N° 00034PC08

LEGENDA:

TR30 H = 2,74 m. s.l.m. ———

TR200 H = 2,75 m. s.l.m. ———

TR500 H = 2,76 m. s.l.m. - - - - -

SCALA DISTANZE 1:200  
SCALA QUOTE 1:200

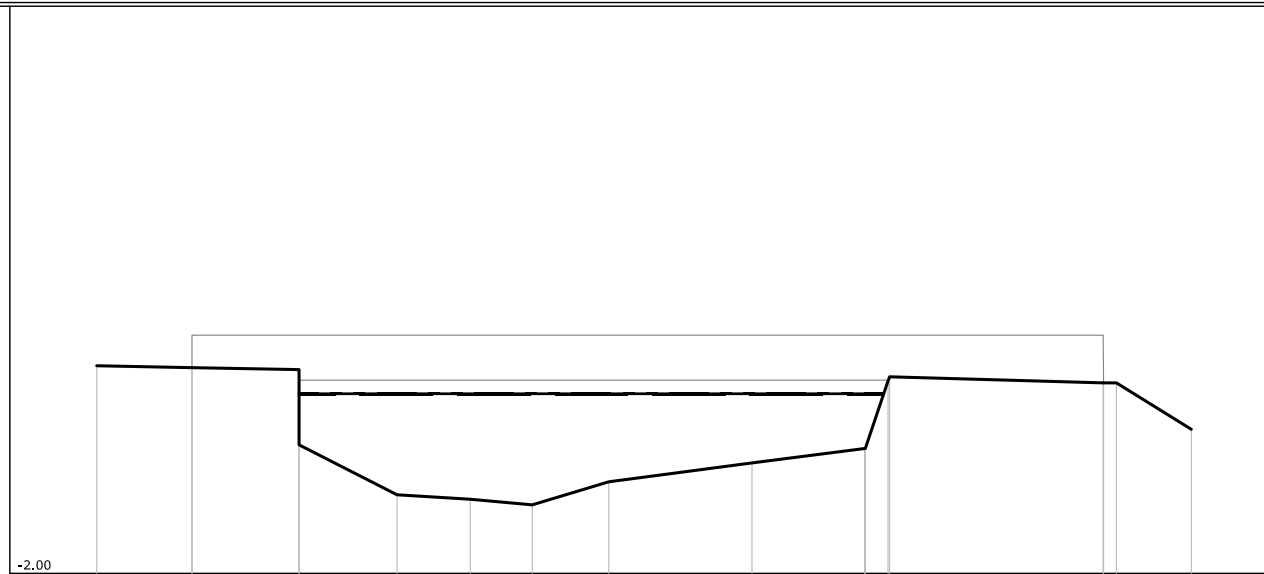



PUNTI	1	2	4	6	7	8	9	10	11	13	15	17	18
QUOTE [m s.l.m.]	3.49	3.44	3.39	0.08	-0.04	-0.19	0.42	0.92	1.30	3.09	3.04	3.04	1.81
DISTANZE PROGRESSIVE [m]	0.00	2.52	5.35	7.94	9.88	11.52	13.54	17.33	20.31	20.93	26.62	26.97	28.95
DISTANZE PARZIALI [m]		2.52	2.83	2.59	1.94	1.64	2.02	3.79	2.98		5.65		1.98

Torrente Parmignola  
 SEZIONE N° 00032\_\_08

LEGENDA:

TR30 H =2.67 m. s.l.m. 

TR200 H =2.69 m. s.l.m. 

TR500 H =2.70 m. s.l.m. 

SCALA DISTANZE 1:200  
 SCALA QUOTE 1:200

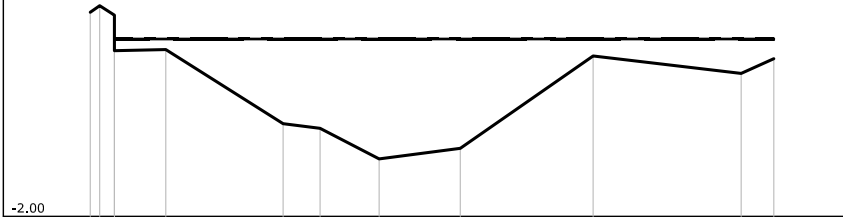



PUNTI	1	2	3	5	6	7	8	9	10	11	12
QUOTE [m s.l.m.]		3.59	3.32	2.41	0.45	0.33	-0.48	-0.20	2.24	1.78	2.17
DISTANZE PROGRESSIVE [m]	0.00	0.64	2.00	5.10	6.08	7.64	9.79	13.30	17.22	18.08	
DISTANZE PARZIALI [m]		1.36	3.10	0.98	1.56	2.15	3.51	3.92			

Torrente Parmignola  
SEZIONE N° 00031\_\_08

LEGENDA:

TR30 H =2.62 m. s.l.m. 

TR200 H =2.64 m. s.l.m. 

TR500 H =2.65 m. s.l.m. 

SCALA DISTANZE 1:200  
SCALA QUOTE 1:200

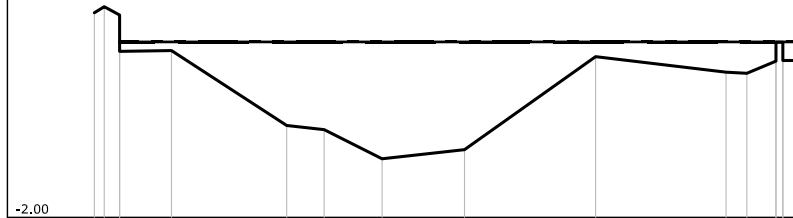

PUNTI	1	2	3	4	5	6	7	8	9	10	11	12	13	14	15	16	17
QUOTE [m s.l.m.]			3.44	3.35	2.41	0.43	0.32	-0.45	-0.21	2.25	1.84	1.81	2.13	2.15			
DISTANZE PROGRESSIVE [m]	0.00	0.90	0.67		2.04	5.09	6.08	7.61	9.79	13.26	16.71	17.26	18.03	18.82			
DISTANZE PARZIALI [m]				1.37	3.05	0.99	1.53	2.18	3.47	3.45							

Torrente Parmignola  
SEZIONE N° 00030\_08

LEGENDA:

TR30 H =2.55 m. s.l.m. ————

TR200 H =2.57 m. s.l.m. —————

TR500 H =2.58 m. s.l.m. - - - - -

SCALA DISTANZE 1:200  
SCALA QUOTE 1:200

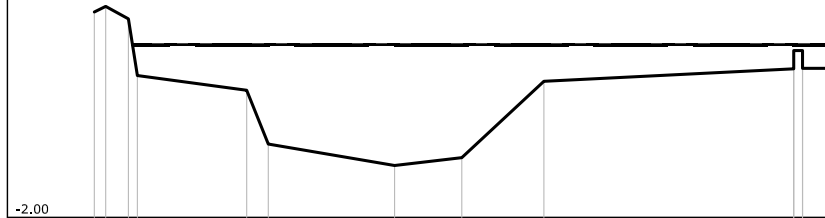



PUNTI	1	2	3	5	6	7	8	9	10	14				
QUOTE [m s.l.m.]		3.43	3.58	3.25		1.36	-0.06		-0.63	-0.42	1.60		1.93	1.94
DISTANZE PROGRESSIVE [m]		0.00	0.30	0.90		4.03	4.60		7.94	9.72	11.89		18.50	19.45
DISTANZE PARZIALI [m]					2.89		3.34	1.78	2.17		6.61			

Torrente Parmignola  
 SEZIONE N° 00029\_08

LEGENDA:

TR30 H = 2.53 m. s.l.m. 

TR200 H = 2.54 m. s.l.m. 

TR500 H = 2.55 m. s.l.m. 

SCALA DISTANZE 1:200  
 SCALA QUOTE 1:200

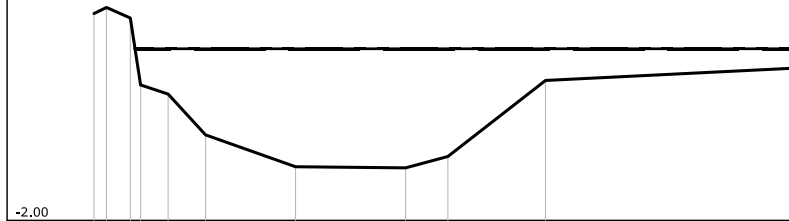

PUNTI	1	2	3	4	5	6	7	8	9	10	11	
QUOTE [m s.l.m.]		3.47	3.63	3.35	1.58	1.34	0.26	-0.58	-0.61	-0.31	1.70	2.03
DISTANZE PROGRESSIVE [m]	0.00	0.33	0.96	1.23	1.96	2.85	5.33	8.24	9.36	11.94	18.62	
DISTANZE PARZIALI [m]					0.99	2.38	2.91	1.12	2.58	6.68		

Torrente Parmignola  
 SEZIONE N° 00028\_08

LEGENDA:

TR30 H =2.43 m. s.l.m. ————

TR200 H =2.44 m. s.l.m. —————

TR500 H =2.45 m. s.l.m. - - - - -

SCALA DISTANZE 1:200  
 SCALA QUOTE 1:200

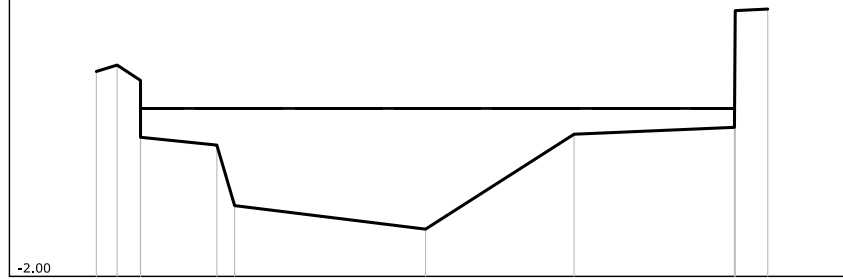

PUNTI	1	2	3	5	6	7	8	9	11
QUOTE [m s.l.m.]	3.42	3.59	3.18	1.47	-0.13	-0.75	1.76	1.94	5.07
DISTANZE PROGRESSIVE [m]	0.00	0.55	1.17	3.19	3.66	8.71	12.64	16.88	17.76
DISTANZE PARZIALI [m]				2.02		5.05	3.93	4.24	

Torrente Parmignola  
 SEZIONE N° 00027\_\_08

LEGENDA:

- TR30 H =2.35 m. s.l.m.
- TR200 H =2.37 m. s.l.m.
- TR500 H =2.38 m. s.l.m.

SCALA DISTANZE 1:200  
 SCALA QUOTE 1:200

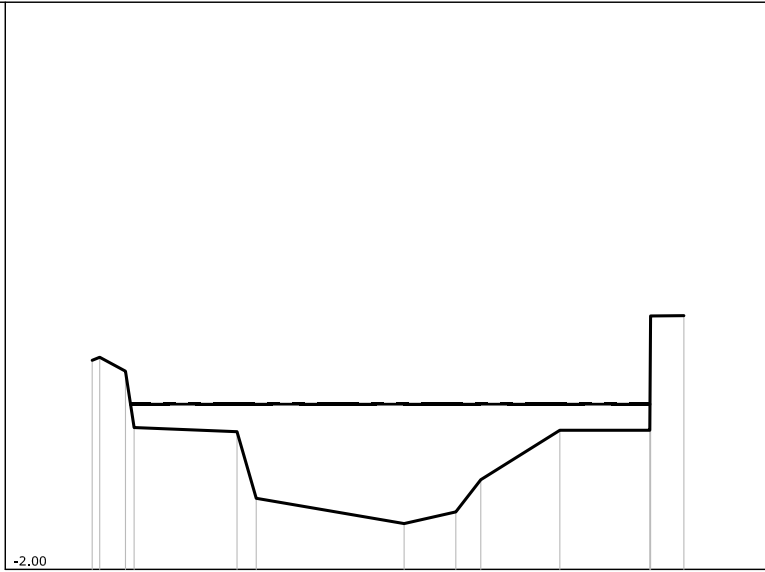

PUNTI	1	3	5	6	7	8	9	10	11	13
QUOTE [m s.l.m.]	3.53	3.24	1.64	-0.12	-0.79	-0.48	0.37	1.68	1.68	4.71
DISTANZE PROGRESSIVE [m]	0.00	0.88	3.83	4.34	8.25	9.62	10.28	12.37	14.75	15.65
DISTANZE PARZIALI [m]			2.72		3.91	1.37		2.09	2.38	

Torrente Parmignola  
SEZIONE N° 00025\_08

LEGENDA:

TR30 H =2.30 m. s.l.m. ————

TR200 H =2.32 m. s.l.m. —————

TR500 H =2.32 m. s.l.m. - - - - -

SCALA DISTANZE 1:200  
SCALA QUOTE 1:200

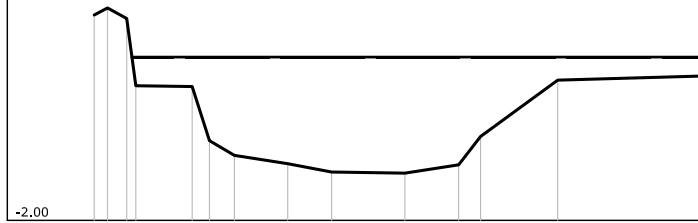

PUNTI	1	2	3	4	5	6	7	8	9	10	11	12	13	14
QUOTE [m s.l.m.]	3.43	3.62	3.36	3.36	1.54	0.11	-0.28	-0.50	-0.72	-0.75	-0.53	0.22	1.71	1.82
DISTANZE PROGRESSIVE [m]	0.00	0.35	0.86	1.10	2.59	3.05	3.71	5.12	6.28	8.22	9.64	10.22	12.26	16.13
DISTANZE PARZIALI [m]					1.49		1.41	1.16	1.94	1.42		2.04	3.87	



Torrente Parmignola  
 SEZIONE N° 00023\_\_08

LEGENDA:

- TR30 H =2.17 m. s.l.m.
- TR200 H =2.19 m. s.l.m.
- TR500 H =2.20 m. s.l.m.

SCALA DISTANZE 1:200  
 SCALA QUOTE 1:200

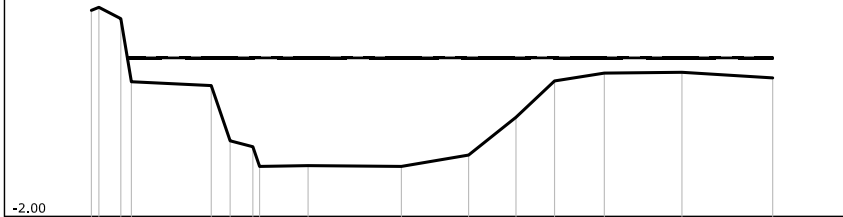



PUNTI	1	3	4	5	6	7	9	10	11	12	13	14	15	16
QUOTE [m s.l.m.]	3.45	3.23	1.56	1.46	0.00	-0.16	-0.66	-0.68	-0.38	0.62	1.58	1.79	1.81	1.66
DISTANZE PROGRESSIVE [m]	0.00	0.78	1.06	3.17	3.67	4.27	5.73	8.20	9.98	11.23	12.25	13.57	15.62	18.02
DISTANZE PARZIALI [m]				2.11			1.28	2.47	1.78	1.25	1.02	1.32	2.05	2.40

Torrente Parmignola  
 SEZIONE N° 00021\_\_08

LEGENDA:

TR30 H =2.05 m. s.l.m. 

TR200 H =2.07 m. s.l.m. 

TR500 H =2.08 m. s.l.m. 

SCALA DISTANZE 1:200  
 SCALA QUOTE 1:200



PUNTI	1	3	5	6	7	8	9	10	11	12	13
QUOTE [m s.l.m.]	3.45	3.23	1.56	0.33	-0.56	-0.73	-0.73	-0.26	1.60	1.58	1.68
DISTANZE PROGRESSIVE [m]	0.00	0.75	2.12	2.61	5.59	6.06	8.89	11.31	13.19	14.95	18.24
DISTANZE PARZIALI [m]		1.15	2.98		2.83	2.42	1.88	1.76	3.29		

Torrente Parmignola  
SEZIONE N° 00017\_\_08

LEGENDA:

TR30 H = 1.99 m. s.l.m. \_\_\_\_\_

TR200 H = 2.00 m. s.l.m. \_\_\_\_\_

TR500 H = 2.01 m. s.l.m. \_\_\_\_\_

SCALA DISTANZE 1:200  
SCALA QUOTE 1:200

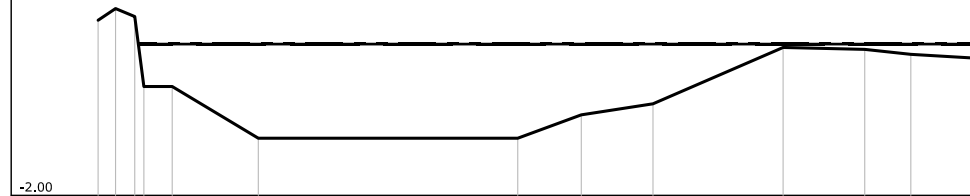

PUNTI	1	2	3	5	6	7	8	9	10	11	12	13
QUOTE [m s.l.m.]	2.63	2.94	2.73	0.88	-0.49	-0.49	0.13	0.42	1.91	1.86	1.73	1.63
DISTANZE PROGRESSIVE [m]	0.00	0.46	0.97	1.96	4.24	11.10	12.78	14.68	18.12	20.28	21.50	23.22
DISTANZE PARZIALI [m]					2.28	6.86	1.68	1.90	3.44	2.16	1.22	1.72

Torrente Parmignola  
 SEZIONE N° 00016\_\_08

LEGENDA:

- TR30 H = 1.92 m. s.l.m.
- TR200 H = 1.93 m. s.l.m.
- TR500 H = 1.94 m. s.l.m.

SCALA DISTANZE 1:200  
 SCALA QUOTE 1:200

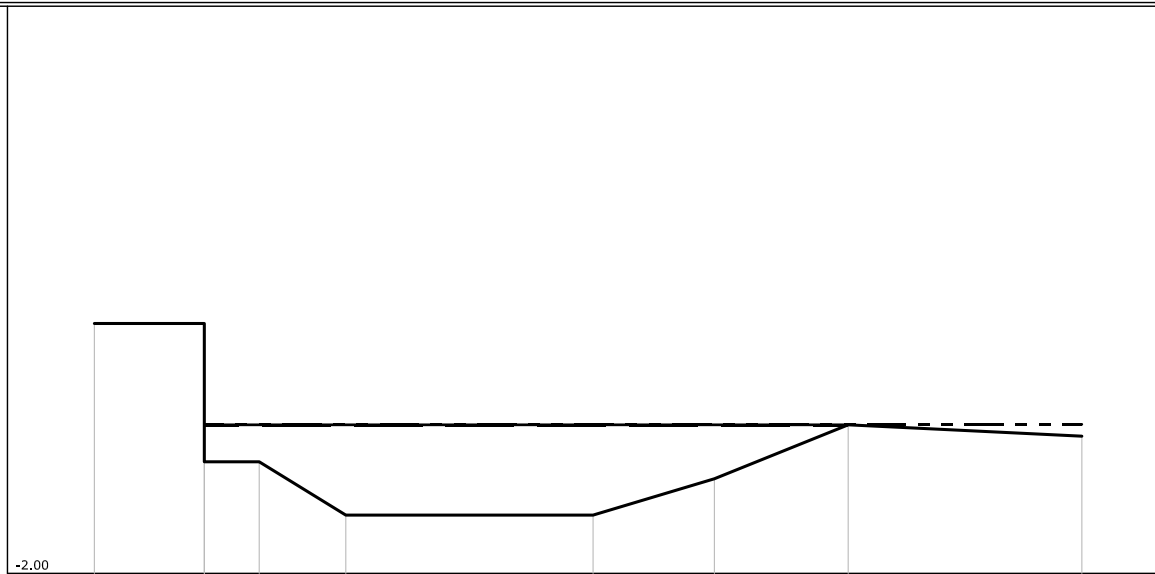

PUNTI	1	2	4	5	6	7	8	9
QUOTE [m s.l.m.]	4.61	4.61	0.95	-0.46	-0.46	0.50	1.93	1.63
DISTANZE PROGRESSIVE [m]	0.00	2.91	4.36	6.65	13.19	16.40	19.94	26.12
DISTANZE PARZIALI [m]		2.91	1.45	2.29	6.54	3.21	3.54	6.18

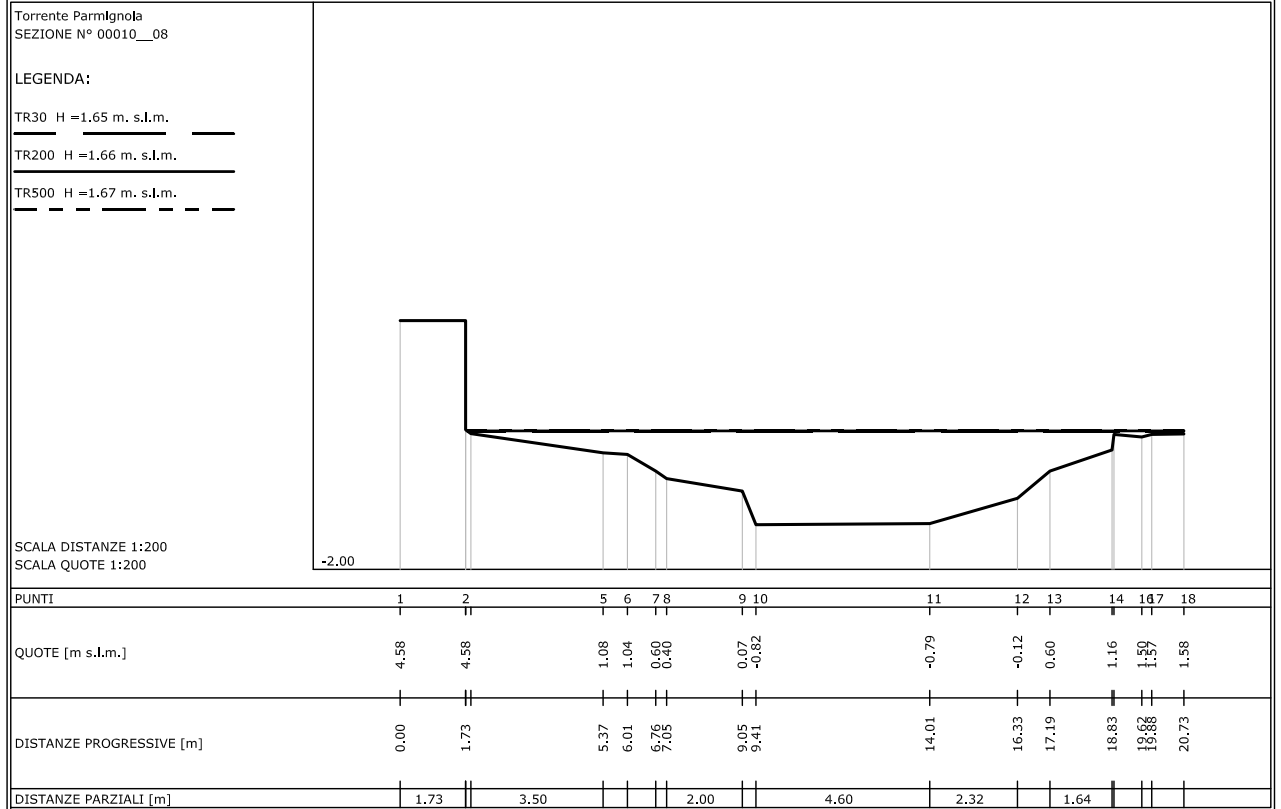

Torrente Parmignola  
 SEZIONE N° 00007\_\_08

LEGENDA:

TR30 H = 1.43 m. s.l.m. ———

TR200 H = 1.44 m. s.l.m. ———

TR500 H = 1.44 m. s.l.m. - - - - -

SCALA DISTANZE 1:200  
 SCALA QUOTE 1:200

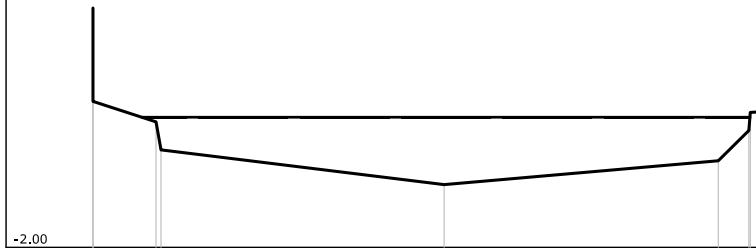

PUNTI	1	3	5	6	7	9
QUOTE [m s.l.m.]	4.33	1.32	-0.34	0.29	1.09	1.59
DISTANZE PROGRESSIVE [m]	0.00	1.67	9.29	16.54	17.35	17.73
DISTANZE PARZIALI [m]		1.67	7.49	7.25		

Torrente Parmignola  
 SEZIONE N° 00005\_\_08

LEGENDA:

TR30 H = 1.19 m. s.l.m. ———

TR200 H = 1.19 m. s.l.m. ———

TR500 H = 1.20 m. s.l.m. - - - - -

SCALA DISTANZE 1:200  
 SCALA QUOTE 1:200

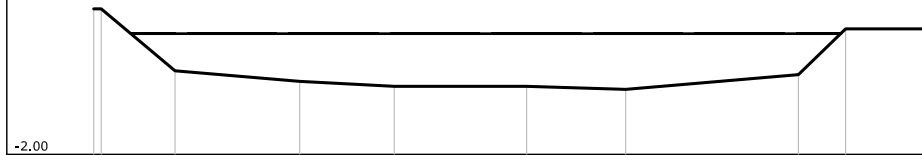



PUNTI	1	3	4	5	6	7	8	9	10
QUOTE [m s.l.m.]	1.85	0.21	-0.07	-0.20	-0.20	-0.28	0.11	1.32	1.32
DISTANZE PROGRESSIVE [m]	0.00	2.15	5.45	7.95	11.45	14.07	18.64	19.89	22.08
DISTANZE PARZIALI [m]		1.95	3.30	2.50	3.50	2.62	4.57	1.25	2.19

Torrente Parmignola  
 SEZIONE N° 00003\_\_08

LEGENDA:

TR30 H = 1.04 m. s.l.m. 

TR200 H = 1.04 m. s.l.m. 

TR500 H = 1.04 m. s.l.m. 

SCALA DISTANZE 1:200  
 SCALA QUOTE 1:200

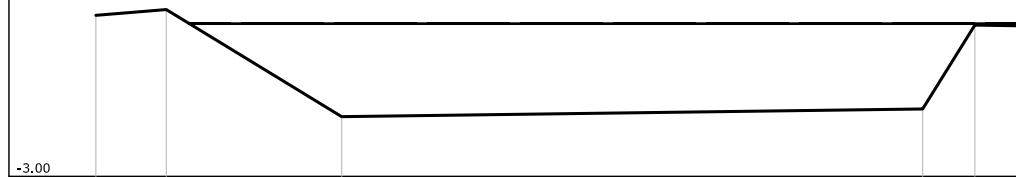



PUNTI	1	2	3	4	5	6
QUOTE [m s.l.m.]	1.26	1.41	-1.42	-1.22	1.00	0.98
DISTANZE PROGRESSIVE [m]	0.00	1.86	6.50	21.87	23.25	24.61
DISTANZE PARZIALI [m]		1.86	4.64	15.37	1.38	1.36



Torrente Parmignola  
 SEZIONE N° 00000\_\_08

LEGENDA:

TR30 H = 1.00 m. s.l.m. 

TR200 H = 1.00 m. s.l.m. 

TR500 H = 1.00 m. s.l.m. 

SCALA DISTANZE 1:200  
 SCALA QUOTE 1:200

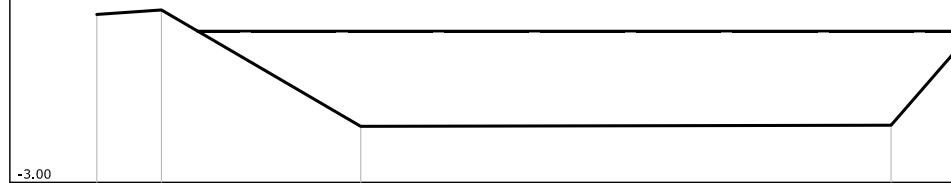



PUNTI	1	2	3	4	5
QUOTE [m s.l.m.]	1.44	1.56	-1.52	-1.49	0.58
DISTANZE PROGRESSIVE [m]	0.00	1.71	6.98	21.01	22.81
DISTANZE PARZIALI [m]		1.71	5.27	14.03	1.80

Fosso di Bocco Barbuto

Fosso dl Bocco Barbuto  
 SEZIONE N° 00119\_\_08

LEGENDA:

TR30 H =29.24 m. s.l.m. 

TR200 H =29.84 m. s.l.m. 

TR500 H =29.96 m. s.l.m. 

SCALA DISTANZE 1:100  
 SCALA QUOTE 1:100

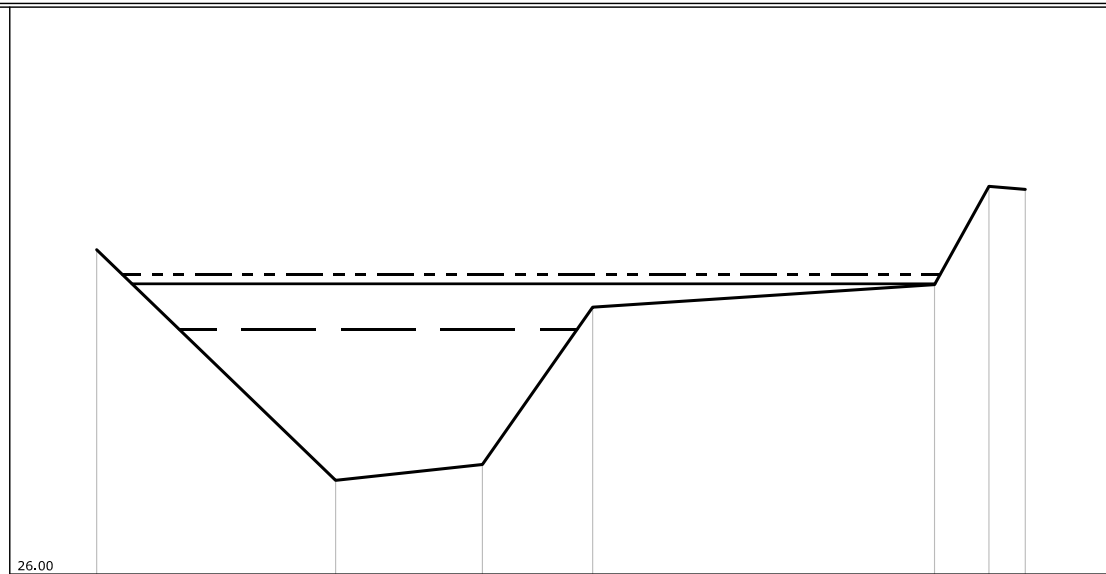

PUNTI	1	2	3	4	5	6	7
QUOTE [m s.l.m.]	30.29	27.24	27.45	29.53	29.83	31.13	31.09
DISTANZE PROGRESSIVE [m]	0.00	3.16	5.10	6.56	11.08	11.80	12.28
DISTANZE PARZIALI [m]		3.16	1.94	1.46	4.52	0.72	

Fosso di Bocco Barbuto  
 SEZIONE N° 00094\_\_08

LEGENDA:

- TR30 H = 21.49 m. s.l.m.
- TR200 H = 21.95 m. s.l.m.
- TR500 H = 22.15 m. s.l.m.

SCALA DISTANZE 1:100  
 SCALA QUOTE 1:100

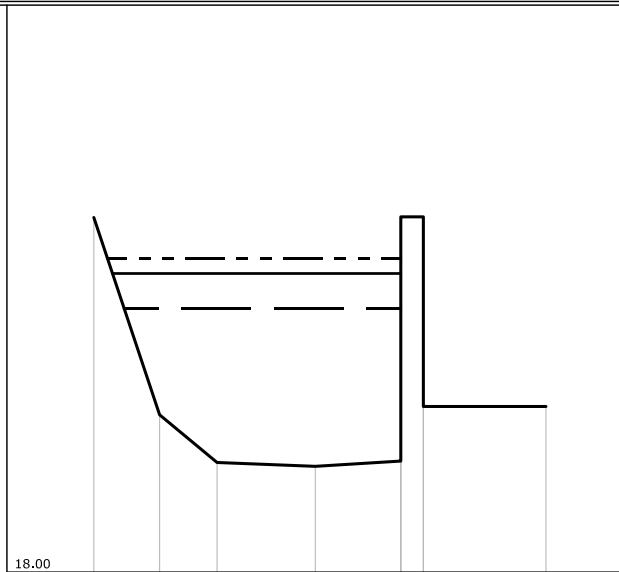

PUNTI	1	2	3	4	5	7	9
QUOTE [m s.l.m.]	22.69	20.08	19.45	19.40	19.47	22.70	20.19
DISTANZE PROGRESSIVE [m]	0.00	0.87	1.63	2.93	4.06	4.36	5.98
DISTANZE PARZIALI [m]		0.87	0.76	1.30	1.13		1.62

Fosso di Bocco Barbuto  
 SEZIONE N° 00086\_\_08

LEGENDA:

TR30 H =20.23 m. s.l.m. 

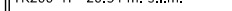
TR200 H =20.54 m. s.l.m. 

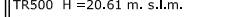
TR500 H =20.61 m. s.l.m. 

SCALA DISTANZE 1:100  
 SCALA QUOTE 1:100

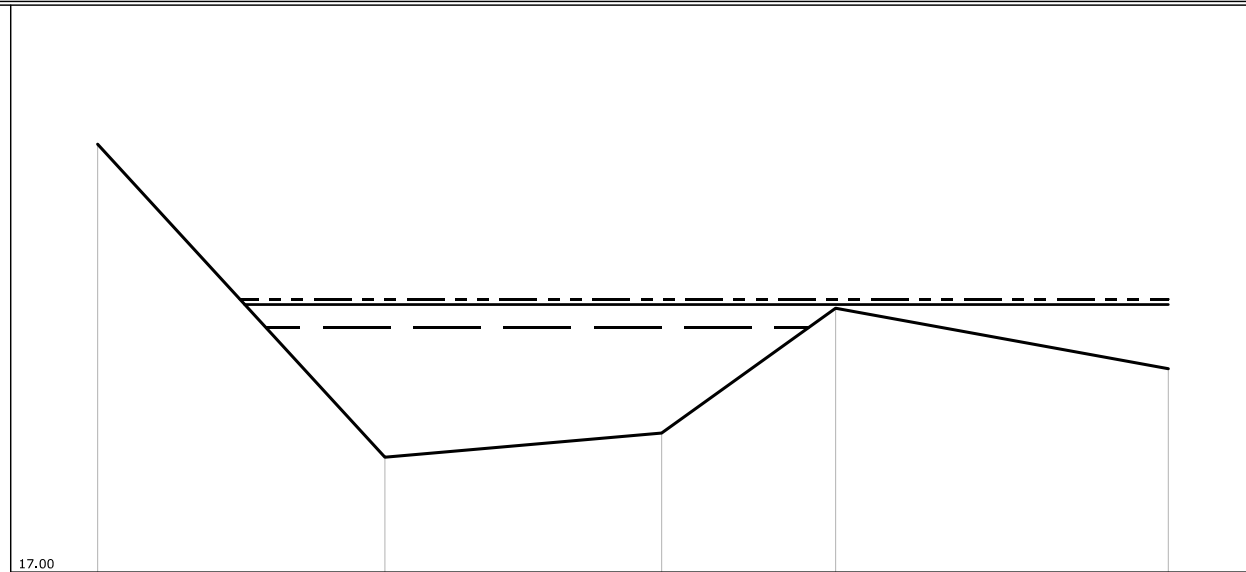



PUNTI	1	2	3	4	5
QUOTE [m s.l.m.]	22.66	18.52	18.84	20.49	19.69
DISTANZE PROGRESSIVE [m]	0.00	3.80	7.46	9.76	14.16
DISTANZE PARZIALI [m]		3.80	3.66	2.30	4.40

Fosso di Bocco Barbuto  
 SEZIONE N° 00082\_\_08

LEGENDA:

TR30 H = 19.43 m. s.l.m. 

TR200 H = 19.62 m. s.l.m. 

TR500 H = 19.67 m. s.l.m. 

SCALA DISTANZE 1:100  
 SCALA QUOTE 1:100

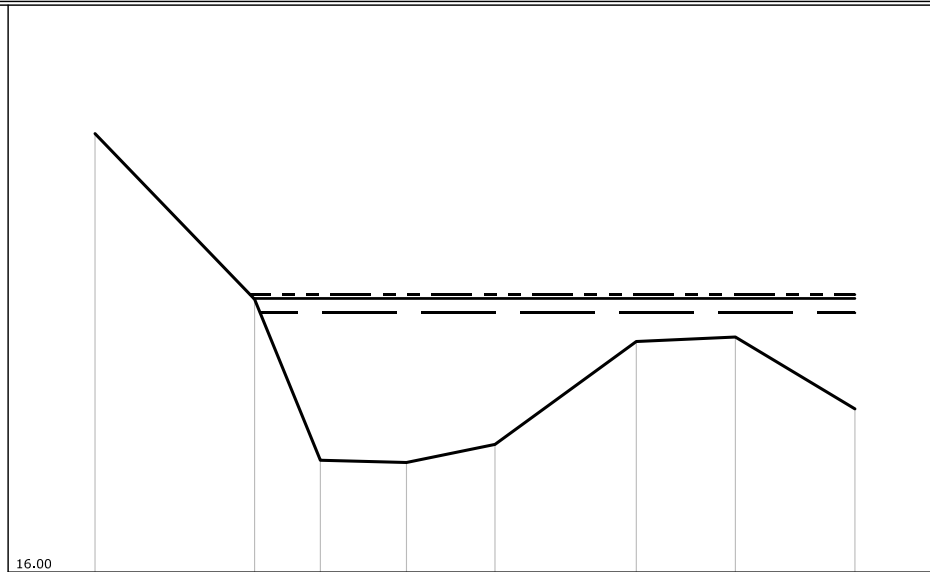

PUNTI	1	2	3	4	5	6	7	8
QUOTE [m s.l.m.]	21.80	19.61	17.48	17.45	17.69	19.05	19.11	18.16
DISTANZE PROGRESSIVE [m]	0.00	2.11	2.98	4.12	5.29	7.16	8.47	10.05
DISTANZE PARZIALI [m]		2.11	0.87	1.14	1.17	1.87	1.31	1.58

Fosso di Bocco Barbuto  
SEZIONE N° 00075\_\_08

LEGENDA:

TR30 H =18.20 m. s.l.m. \_\_\_\_\_

TR200 H =18.25 m. s.l.m. \_\_\_\_\_

TR500 H =18.26 m. s.l.m. - - - - -

SCALA DISTANZE 1:100  
SCALA QUOTE 1:100

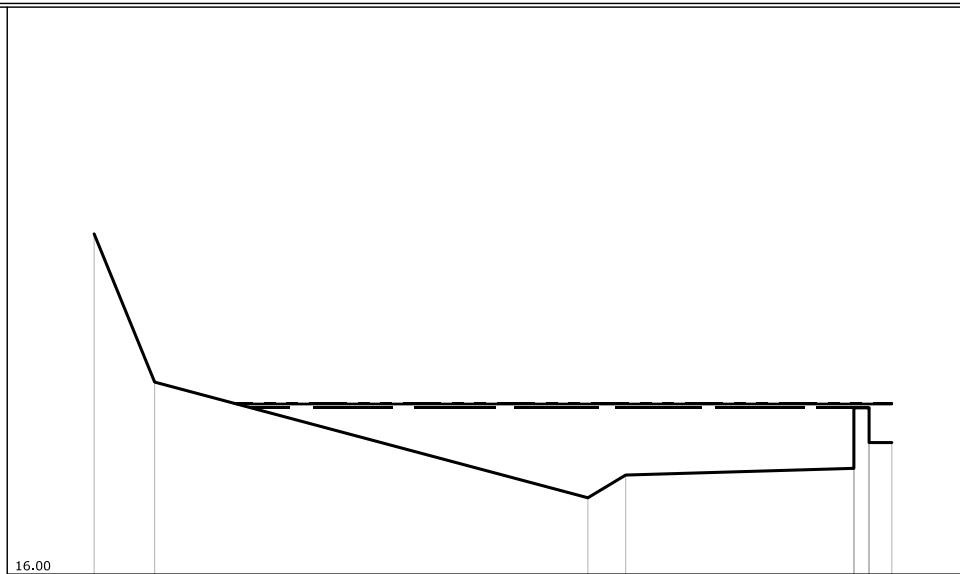

PUNTI	1	2	3	4	5	7	9
QUOTE [m s.l.m.]	20.50	18.54	17.01	17.31	17.40	18.20	17.74
DISTANZE PROGRESSIVE [m]	0.00	0.80	6.53	7.03	10.05	10.25	10.55
DISTANZE PARZIALI [m]		0.80	5.73	0.50	3.02		

Fosso di Bocco Barbuto  
 SEZIONE N° 00072\_\_08

LEGENDA:

- TR30 H = 17.24 m. s.l.m.
- TR200 H = 17.28 m. s.l.m.
- TR500 H = 17.30 m. s.l.m.

SCALA DISTANZE 1:100  
 SCALA QUOTE 1:100

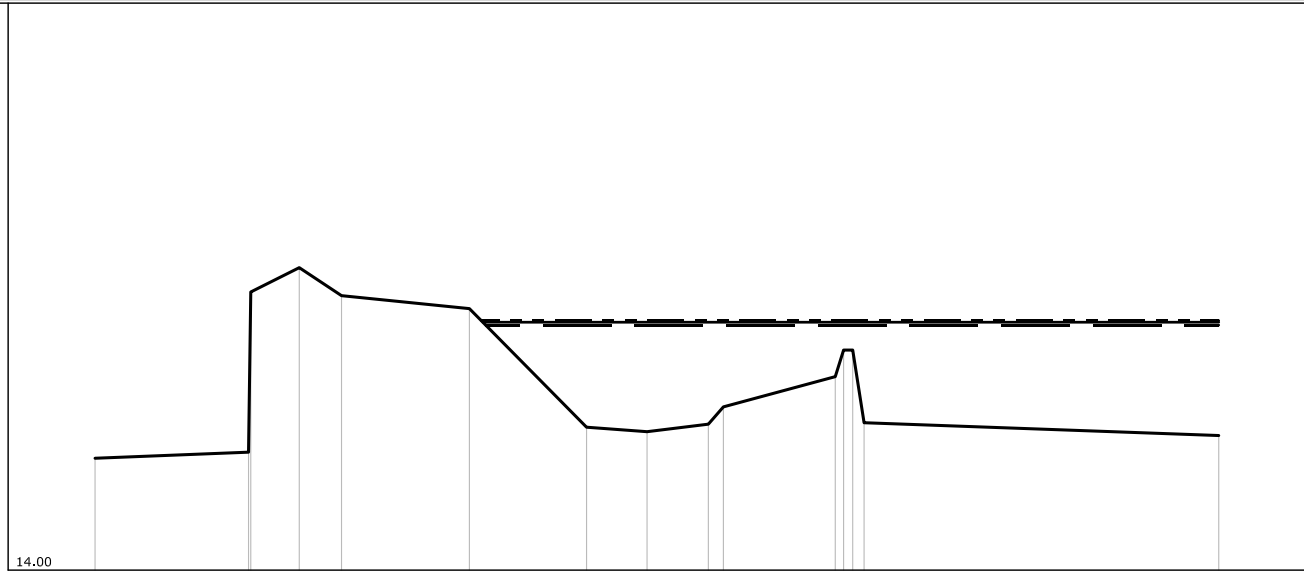



PUNTI	1	2	4	5	6	7	8	9	10	11	13	14	15
QUOTE [m s.l.m.]	15.48	15.56	18.00	17.63	17.46	15.89	15.83	15.93	16.16	16.56	16.91	15.95	15.78
DISTANZE PROGRESSIVE [m]	0.00	2.03	2.70	3.26	4.95	6.50	7.30	8.11	8.31	9.79	10.02	10.17	14.86
DISTANZE PARZIALI [m]		2.03	0.64	0.56	1.69	1.55	0.80	0.81		1.48			4.69



Fosso di Bocco Barbuto  
 SEZIONE N° 00069\_08

LEGENDA:

TR30 H = 16.80 m. s.l.m. 

TR200 H = 16.83 m. s.l.m. 

TR500 H = 16.84 m. s.l.m. 

SCALA DISTANZE 1:100  
 SCALA QUOTE 1:100

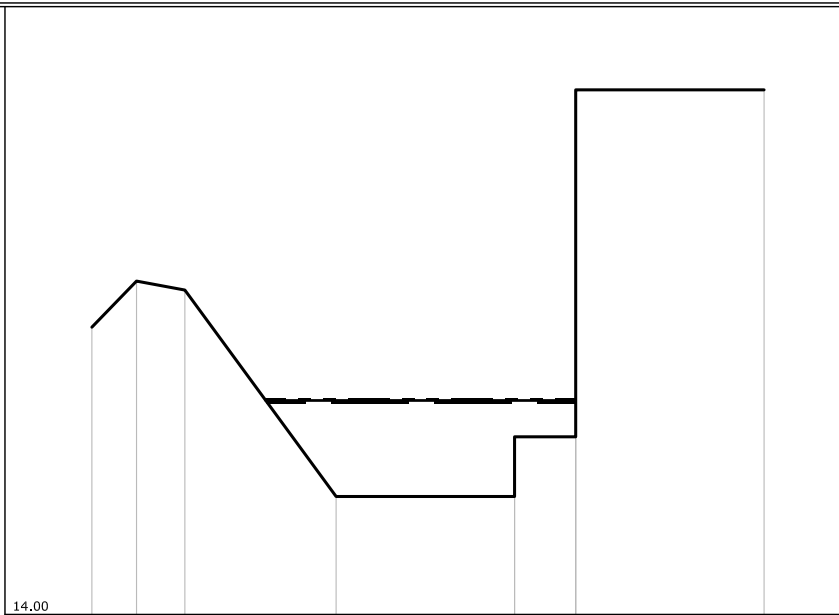

PUNTI	1	2	3	4	5	7	9
QUOTE [m s.l.m.]	17.80	18.41	18.29	15.56	15.56	16.35	20.94
DISTANZE PROGRESSIVE [m]	0.00	0.59	1.23	3.23	5.59	6.40	8.89
DISTANZE PARZIALI [m]	0.59	0.64	2.00	2.36	0.81	2.49	

Fosso di Bocco Barbuto  
SEZIONE N° 00067\_\_08

LEGENDA:

- TR30 H = 16.66 m. s.l.m.
- TR200 H = 16.74 m. s.l.m.
- TR500 H = 16.77 m. s.l.m.

SCALA DISTANZE 1:100  
SCALA QUOTE 1:100

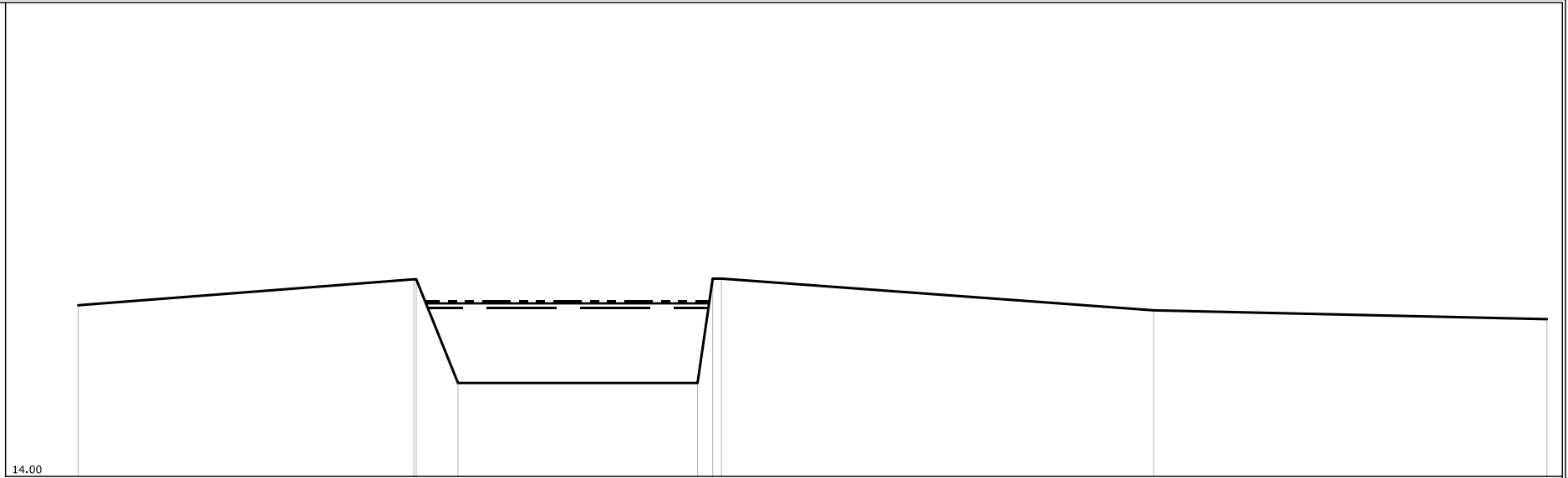

PUNTI	1	2	5	6	7	8	9	10
QUOTE [m s.l.m.]	16.71	17.12	15.48	15.48	17.13	17.13	16.63	16.49
DISTANZE PROGRESSIVE [m]	0.00	5.31	6.01	9.80	10.04	10.08	17.02	23.24
DISTANZE PARZIALI [m]		5.31	0.66	3.79			6.84	6.22

Fosso di Bocca Barbuto  
 SEZIONE N° 00066PB08

LEGENDA:

TR30 H = 16.68 m. s.l.m. ———

TR200 H = 16.75 m. s.l.m. ———

TR500 H = 16.79 m. s.l.m. - - - - -

SCALA DISTANZE 1:100  
 SCALA QUOTE 1:100

13.00

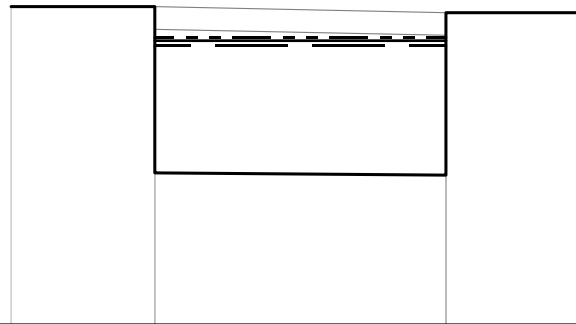

PUNTI	1	2	4	6
QUOTE [m s.l.m.]	17.20	17.20	14.97	17.12
DISTANZE PROGRESSIVE [m]	0.00	1.90	5.75	7.60
DISTANZE PARZIALI [m]		1.90	3.85	1.85

Fosso di Bocca Barbuto  
 SEZIONE N° 00066PC08

LEGENDA:

TR30 H = 16.64 m. s.l.m. \_\_\_\_\_

TR200 H = 16.72 m. s.l.m. \_\_\_\_\_

TR500 H = 16.75 m. s.l.m. - - - - -

SCALA DISTANZE 1:100  
 SCALA QUOTE 1:100

13.00

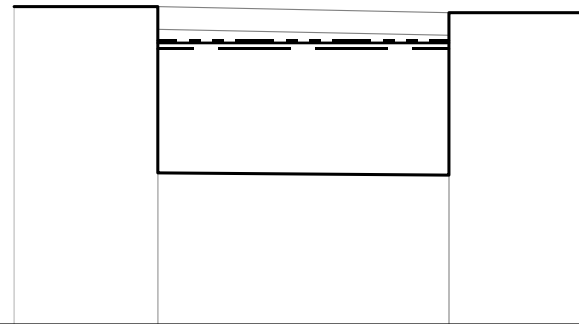

PUNTI	1	2	4	6
QUOTE [m s.l.m.]	17.20	17.20	14.97	17.12
DISTANZE PROGRESSIVE [m]	0.00	1.90	5.75	7.60
DISTANZE PARZIALI [m]		1.90	3.85	1.85

Fosso di Bocco Barbuto  
 SEZIONE N° 00062\_\_08

LEGENDA:

TR30 H = 16.52 m. s.l.m. ———

TR200 H = 16.61 m. s.l.m. ———

TR500 H = 16.66 m. s.l.m. - - - - -

SCALA DISTANZE 1:100  
 SCALA QUOTE 1:100

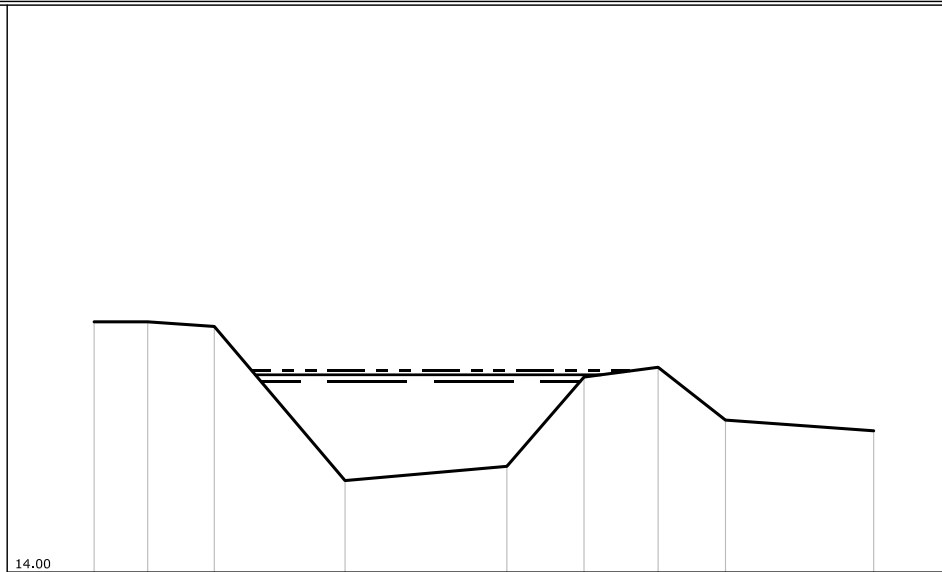

PUNTI	1	2	3	4	5	6	7	8	9
QUOTE [m s.l.m.]	17.31	17.31	17.25	15.21	15.40	16.58	16.71	16.01	15.87
DISTANZE PROGRESSIVE [m]	0.00	0.71	1.59	3.32	5.46	6.48	7.46	8.35	10.31
DISTANZE PARZIALI [m]		0.71	0.88	1.73	2.14	1.02	0.98	0.89	1.96

Fosso di Bocco Barbuto  
SEZIONE N° 00060\_\_08

LEGENDA:

TR30 H = 16.41 m. s.l.m. \_\_\_\_\_

TR200 H = 16.54 m. s.l.m. \_\_\_\_\_

TR500 H = 16.59 m. s.l.m. - - - - -

SCALA DISTANZE 1:100  
SCALA QUOTE 1:100

13.00

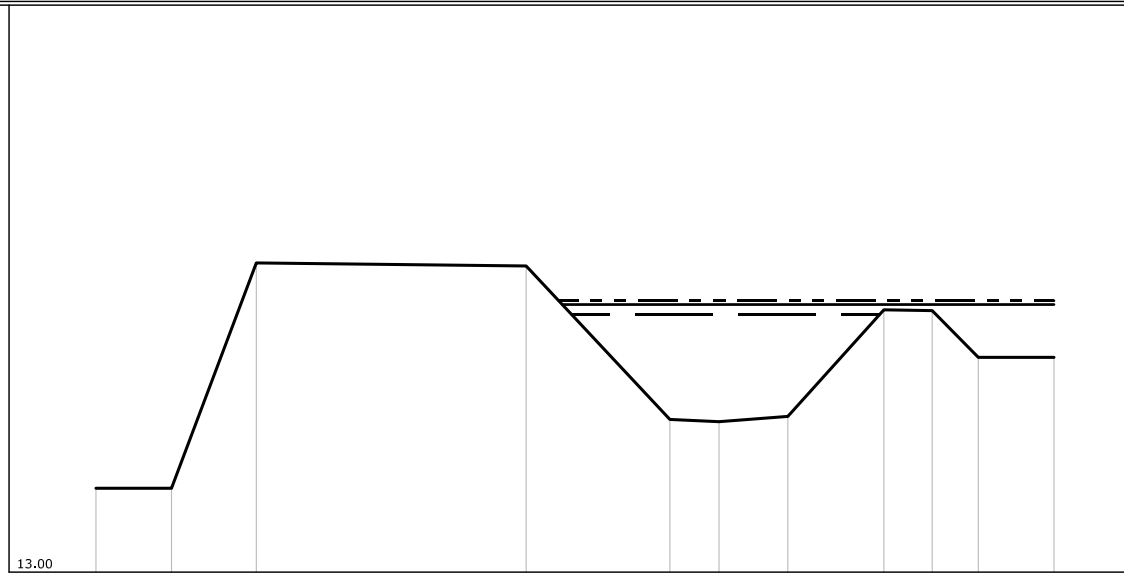

PUNTI	1	2	3	4	5	6	7	8	9	10	11
QUOTE [m s.l.m.]	14.11	14.11	17.09	17.05	15.02	14.99	15.06	16.47	16.46	15.84	15.84
DISTANZE PROGRESSIVE [m]	0.00	1.00	2.12	5.69	7.89	8.24	9.15	10.42	11.06	11.67	12.67
DISTANZE PARZIALI [m]		1.00	1.12	3.57	1.90	0.65	0.91	1.27	0.64	0.61	1.00

Fosso di Bocco Barbuto  
SEZIONE N° 00057\_\_08

LEGENDA:

TR30 H = 16.25 m. s.l.m. ———

TR200 H = 16.42 m. s.l.m. ———

TR500 H = 16.46 m. s.l.m. - - - - -

SCALA DISTANZE 1:100  
SCALA QUOTE 1:100

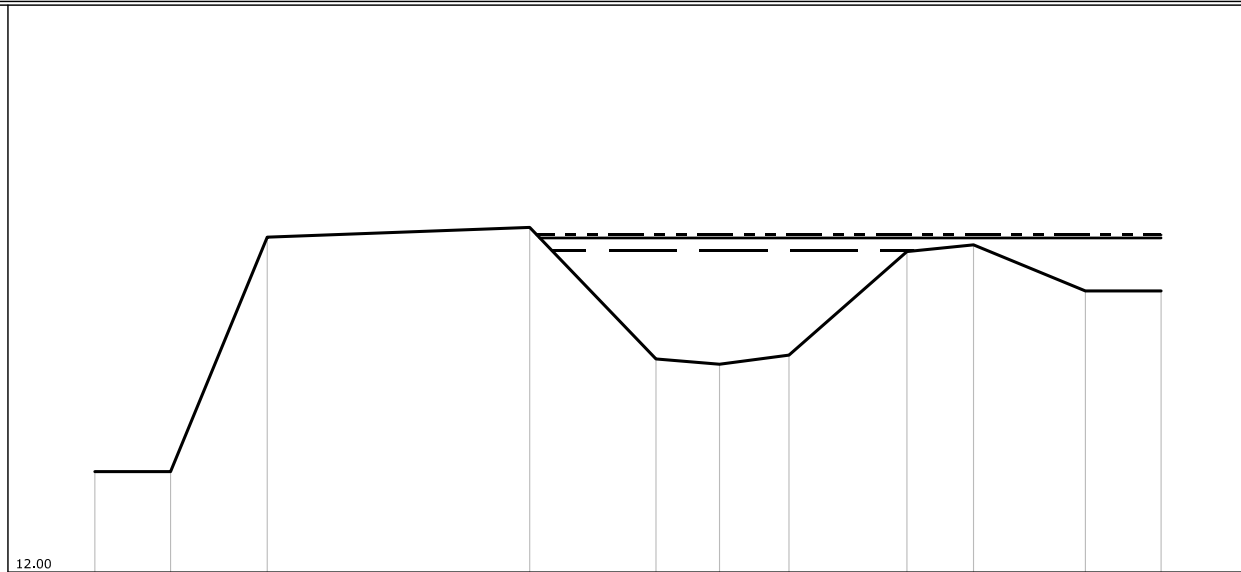

PUNTI	1	2	3	4	5	6	7	8	9	10	11
QUOTE [m s.l.m.]	13.33	13.33	16.43	16.56	14.82	14.75	14.87	16.24	16.33	15.72	15.72
DISTANZE PROGRESSIVE [m]	0.00	1.00	2.28	5.75	7.42	8.26	9.18	10.74	11.62	13.10	14.10
DISTANZE PARZIALI [m]		1.00	1.28	3.47	1.67	0.84	0.92	1.56	0.88	1.48	1.00

Fosso di Bocco Barbuto  
 SEZIONE N° 00053\_\_08

LEGENDA:

TR30 H =16.09 m. s.l.m. ————

TR200 H =16.18 m. s.l.m. ————

TR500 H =16.20 m. s.l.m. - - - - -

SCALA DISTANZE 1:100  
 SCALA QUOTE 1:100

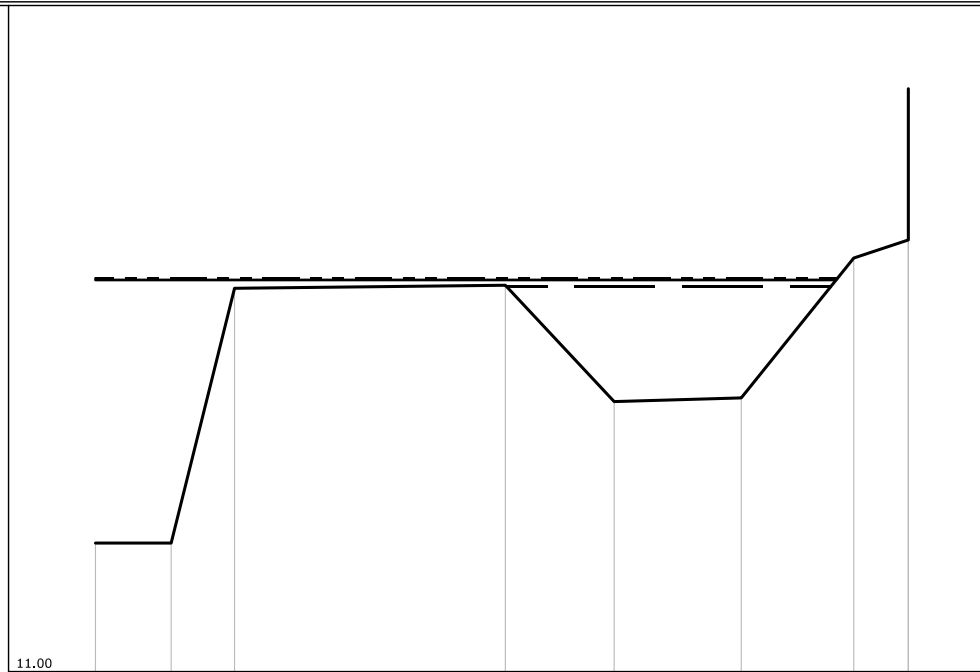



PUNTI	1	2	3	4	5	6	7	8
QUOTE [m s.l.m.]	12.70	12.70	16.07	16.11	14.57	14.62	16.47	16.71
DISTANZE PROGRESSIVE [m]	0.00	1.00	1.84	5.42	6.86	8.54	10.03	10.75
DISTANZE PARZIALI [m]		1.00	0.84	3.58	1.44	1.68	1.49	0.72



Fosso di Bocco Barbuto  
 SEZIONE N° 00049\_\_08

LEGENDA:

TR30 H =16.06 m. s.l.m. 

TR200 H =16.16 m. s.l.m. 

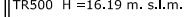
TR500 H =16.19 m. s.l.m. 

SCALA DISTANZE 1:100  
 SCALA QUOTE 1:100

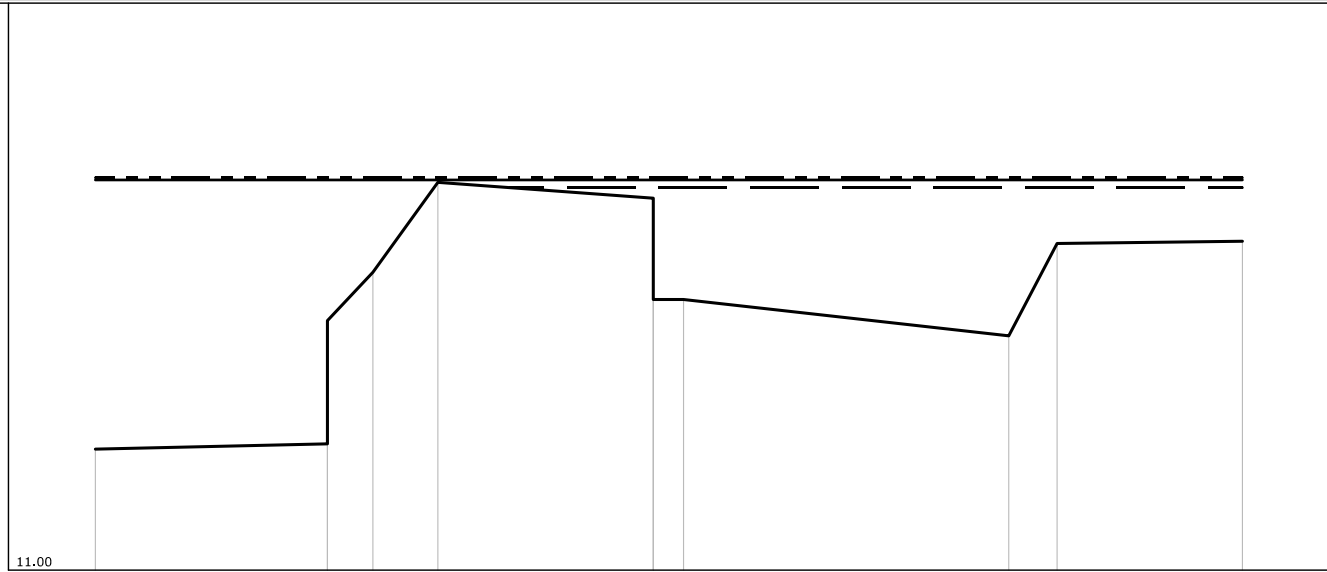

PUNTI	1	2	4	5	6	8	9	10	11
QUOTE [m s.l.m.]	12.60	12.67	14.94	16.13	15.92	14.58	14.10	15.32	15.35
DISTANZE PROGRESSIVE [m]	0.00	3.07	3.67	4.53	7.38	7.78	12.08	12.72	15.17
DISTANZE PARZIALI [m]		3.07	0.60	0.86	2.85		4.30	0.64	2.45

Fosso di Bocco Barbuto  
SEZIONE N° 00045\_\_08

LEGENDA:

TR30 H = 16.00 m. s.l.m. \_\_\_\_\_

TR200 H = 16.11 m. s.l.m. \_\_\_\_\_

TR500 H = 16.15 m. s.l.m. - - - - -

SCALA DISTANZE 1:100  
SCALA QUOTE 1:100

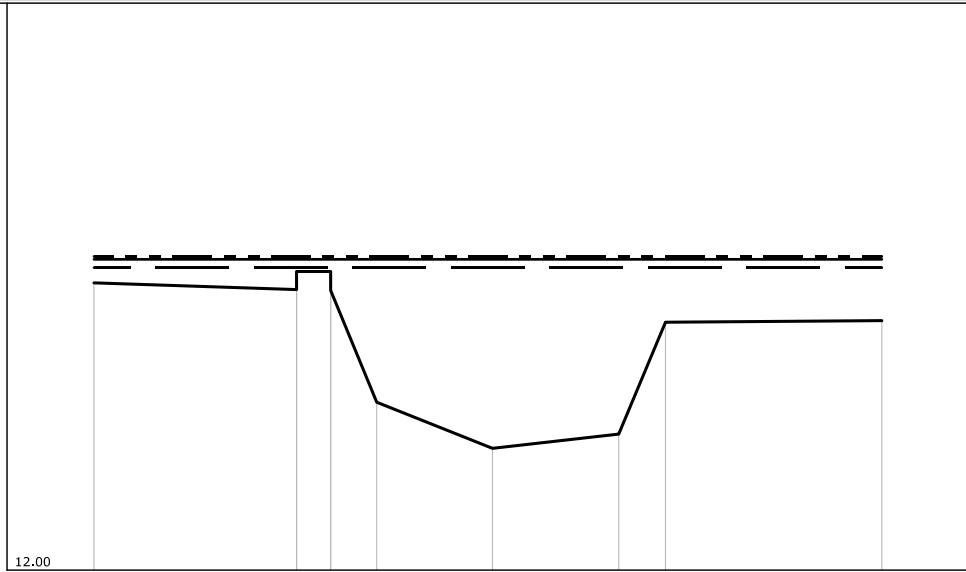



PUNTI	1	2	4	6	7	8	9	10
QUOTE [m s.l.m.]	15.80	15.71	15.95	14.22	13.61	13.80	15.28	15.30
DISTANZE PROGRESSIVE [m]	0.00	2.68	3.13	3.74	5.27	6.94	7.56	10.42
DISTANZE PARZIALI [m]		2.68	0.61	1.53	1.67	0.62	2.86	

Fosso di Bocco Barbuto  
 SEZIONE N° 00033\_\_08

LEGENDA:

TR30 H =15.59 m. s.l.m. 

TR200 H =15.69 m. s.l.m. 

TR500 H =15.71 m. s.l.m. 

SCALA DISTANZE 1:100  
 SCALA QUOTE 1:100

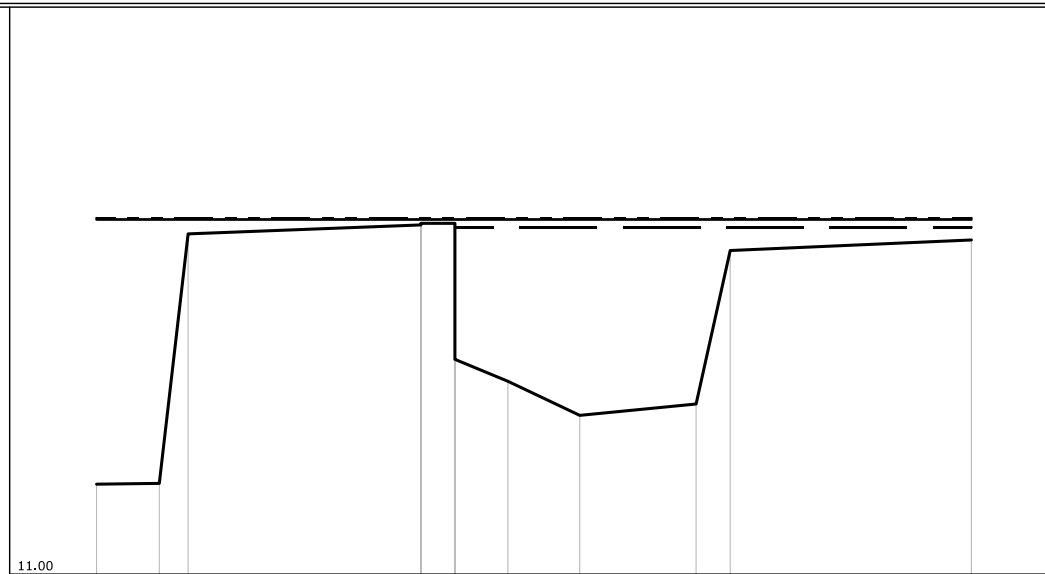

PUNTI	1	2	3	4	6	8	9	10	11	12
QUOTE [m s.l.m.]	12.19	12.20	15.50	15.62	15.64	13.55	13.10	13.25	15.28	15.42
DISTANZE PROGRESSIVE [m]	0.00	0.83	1.21	4.29	4.74	5.44	6.39	7.93	8.38	11.57
DISTANZE PARZIALI [m]		0.83		3.08		0.70	0.95	1.54		3.19

Fosso di Bocco Barbuto  
SEZIONE N° 00022\_\_08

LEGENDA:

TR30 H = 15.10 m. s.l.m. ———

TR200 H = 15.32 m. s.l.m. ———

TR500 H = 15.40 m. s.l.m. - - - - -

SCALA DISTANZE 1:100  
SCALA QUOTE 1:100

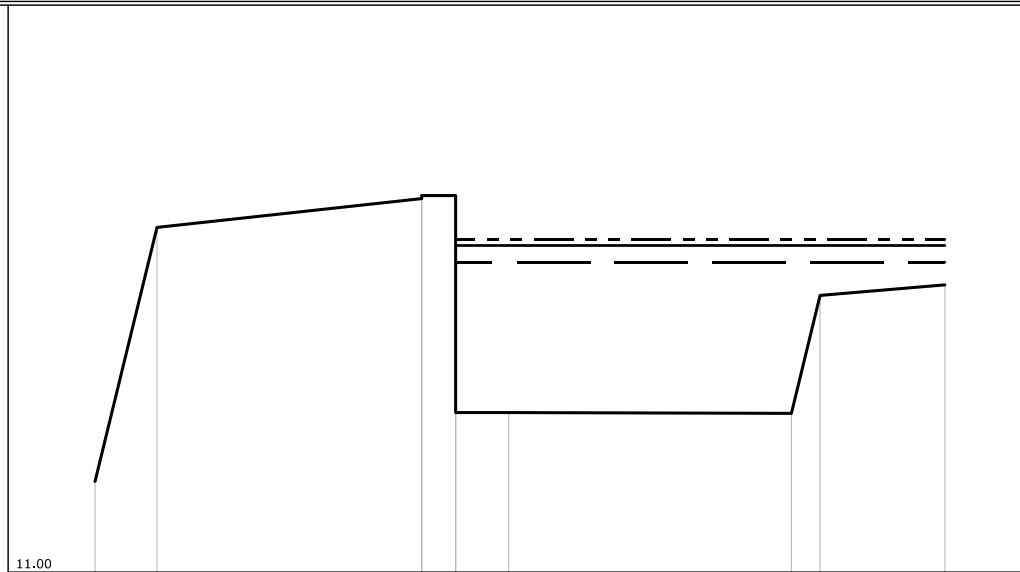

PUNTI	1	2	3	5	7	8	9	10
QUOTE [m s.l.m.]	12.20	15.56	15.94	15.98	13.11	13.10	14.66	14.80
DISTANZE PROGRESSIVE [m]	0.00	0.82	4.32	4.77	5.47	9.21	9.59	11.24
DISTANZE PARZIALI [m]		0.82	3.50	0.70	3.74		1.65	

Fosso di Bocco Barbuto  
 SEZIONE N° 00015\_\_08

LEGENDA:

TR30 H =14.62 m. s.l.m.

TR200 H =14.85 m. s.l.m.

TR500 H =14.94 m. s.l.m.

SCALA DISTANZE 1:100  
 SCALA QUOTE 1:100

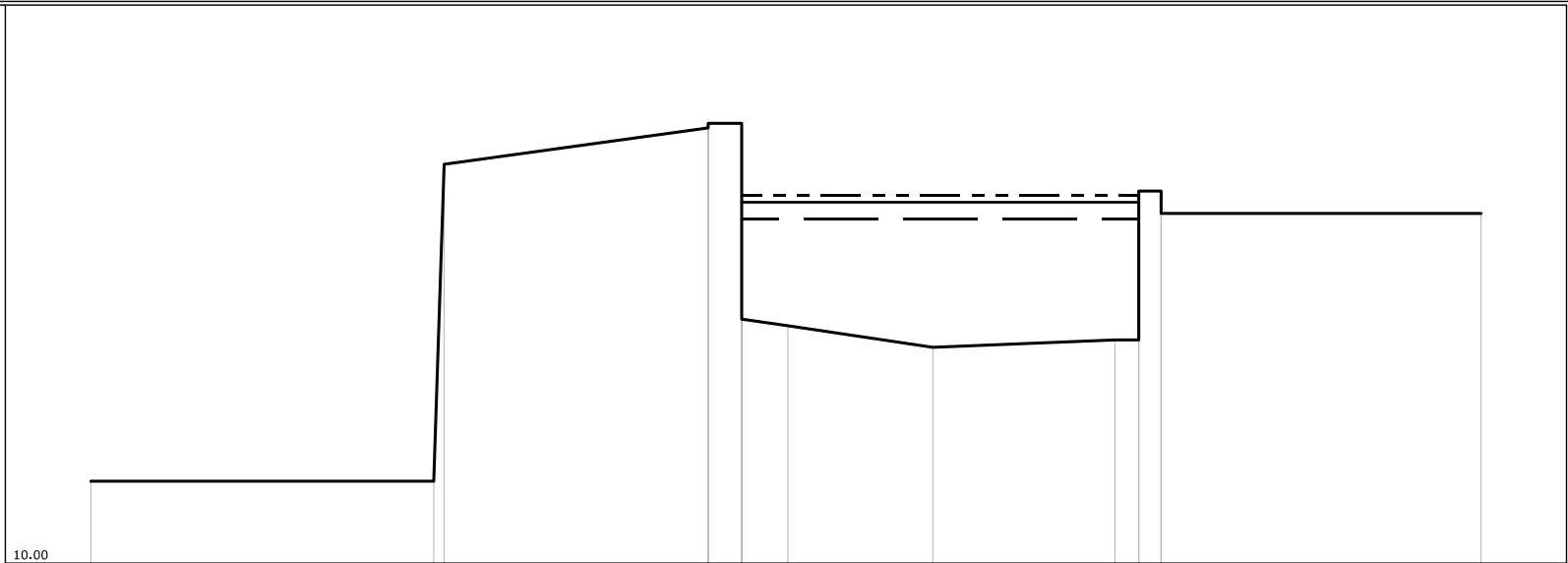



PUNTI	1	2	3	4	6	8	9	10	11	13	15
QUOTE [m s.l.m.]	11.10	11.10	11.10	15.85	15.91	13.19	12.90	13.00	13.00	15.00	14.70
DISTANZE PROGRESSIVE [m]	0.00	4.61	4.75	8.30	8.75	9.37	11.32	13.77	14.09	14.39	18.69
DISTANZE PARZIALI [m]		4.61		3.55		0.62	1.95	2.45			4.30

Fosso di Bocco Barbuto  
SEZIONE N° 00008\_\_08

LEGENDA:

TR30 H = 14.05 m. s.l.m. 

TR200 H = 14.47 m. s.l.m. 

TR500 H = 14.64 m. s.l.m. 

SCALA DISTANZE 1:100  
SCALA QUOTE 1:100

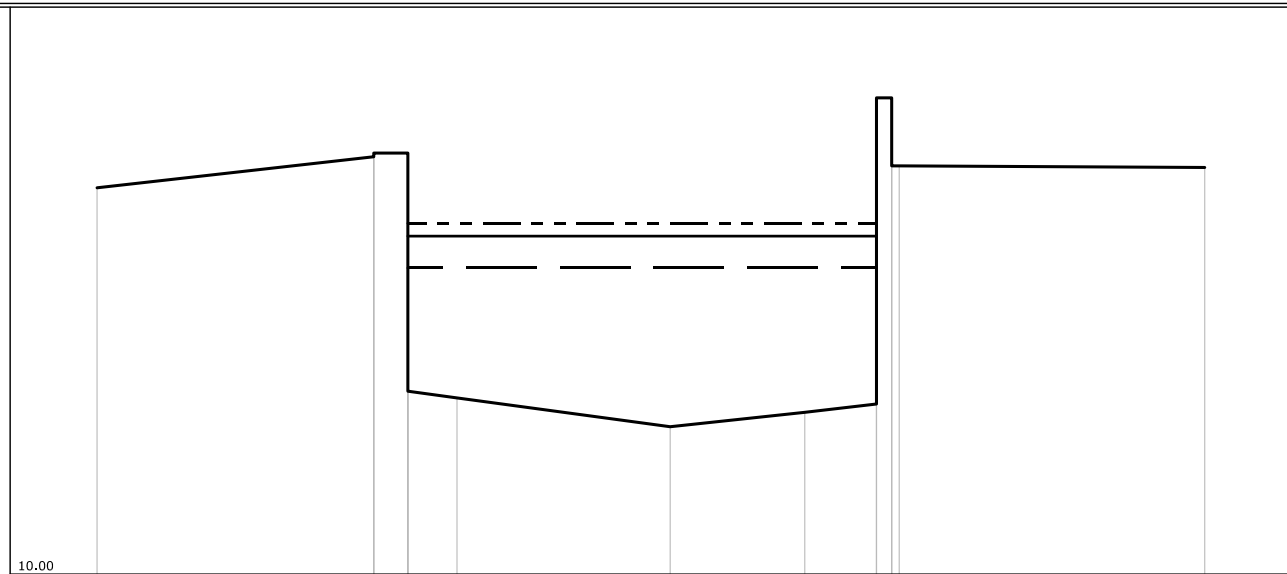

PUNTI	1	2	4	6	7	8	9	12	15
QUOTE [m s.l.m.]	15.11	15.52	15.57	12.33	11.95	12.14	12.25	16.30	15.38
DISTANZE PROGRESSIVE [m]	0.00	3.66	4.11	4.76	7.58	9.36	10.31	10.51	14.65
DISTANZE PARZIALI [m]		3.66	0.65	2.82	1.78	0.95		4.04	